



# Infor CloudSuite Business Manufacturing User Guide

Release 9.01.x

**Copyright © 2016 Infor**

## **Important Notices**

The material contained in this publication (including any supplementary information) constitutes and contains confidential and proprietary information of Infor.

By gaining access to the attached, you acknowledge and agree that the material (including any modification, translation or adaptation of the material) and all copyright, trade secrets and all other right, title and interest therein, are the sole property of Infor and that you shall not gain right, title or interest in the material (including any modification, translation or adaptation of the material) by virtue of your review thereof other than the non-exclusive right to use the material solely in connection with and the furtherance of your license and use of software made available to your company from Infor pursuant to a separate agreement, the terms of which separate agreement shall govern your use of this material and all supplemental related materials ("Purpose").

In addition, by accessing the enclosed material, you acknowledge and agree that you are required to maintain such material in strict confidence and that your use of such material is limited to the Purpose described above. Although Infor has taken due care to ensure that the material included in this publication is accurate and complete, Infor cannot warrant that the information contained in this publication is complete, does not contain typographical or other errors, or will meet your specific requirements. As such, Infor does not assume and hereby disclaims all liability, consequential or otherwise, for any loss or damage to any person or entity which is caused by or relates to errors or omissions in this publication (including any supplementary information), whether such errors or omissions result from negligence, accident or any other cause.

Without limitation, U.S. export control laws and other applicable export and import laws govern your use of this material and you will neither export or re-export, directly or indirectly, this material nor any related materials or supplemental information in violation of such laws, or use such materials for any purpose prohibited by such laws.

## **Trademark Acknowledgements**

The word and design marks set forth herein are trademarks and/or registered trademarks of Infor and/or related affiliates and subsidiaries. All rights reserved. All other company, product, trade or service names referenced may be registered trademarks or trademarks of their respective owners.

## **Publication Information**

Release: Infor Cloudsuite Business (Industrial) 9.01.x

Publication Date: October 3, 2016

Document code: csbi\_9.01.x\_csbiipmug\_csbusiness\_en-us

# Contents

- Contacting Infor.....7**
  
- Chapter 1: Defining Routings and Bills of Material.....9**
  - BOM Bulk Import Forms Overview.....9
  - Using the BOM Bulk Import Utility.....10
  - Using the BOM Import Builder.....11
  - Creating Routings and Bills of Material.....11
  - Adding Routing/BOM Information with Engineering Workbench.....12
  - Adding Routing/BOM Information Manually.....14
  - Copying Routings/BOMs.....15
    - Copying Routings/BOMs with the Copy Routing/BOM or Engineering Workbench.....15
    - Copying Routings/BOMs with the Job Orders or Estimate Job Orders Forms.....17
  - Copying Alternate Materials.....17
  - How Alternate Materials Are Copied.....18
  - Exporting a Bill of Material Structure to an XML Document.....18
  
- Chapter 2: Setting Up Work Shifts.....21**
  - Defining the Work Week.....21
  - Defining Shift Exceptions.....23
  - Shift Exception Examples.....24
  - Handling Shift Overrun.....25
  - How "Must Complete" and "Allow Overrun" Affect Resource Allocation Decisions.....26
  
- Chapter 3: Defining Resources.....29**
  - Resources Overview.....29
  - Handling Resource Reallocation During Interruptions.....31
  - Entering Indirect Labor Codes.....33
  - Deleting Indirect Labor Codes.....33
  - Optimizing Resource Selection in the Scheduler.....33
  - About Infinite Resource Capacity.....34
  - Viewing Resource Utilization Records.....36
  - About Resource Groups.....36
  - Viewing Resource Group Utilization Records.....37
  
- Chapter 4: Defining Work Centers.....39**
  - Work Centers Overview.....39
  - Creating a Department.....39
  - Setting Up Multiple Locations/Common Work Center.....40

<b>Chapter 5: Using Jobs.....</b>	<b>41</b>
Job Steps.....	41
Creating Jobs.....	42
Creating an Estimate Job.....	42
Creating a Job Order.....	43
Creating a Job Order Manually.....	43
Copying a Job Order.....	45
Creating Sub-Jobs.....	46
Creating a Sub-Job through Cross-Referencing.....	47
Cross-referencing a Job Material to a Job.....	47
Cross-Referencing a Job Material to a PO Requisition.....	48
Cross-Referencing a Job Material to a Purchase Order.....	49
Cross-referencing a Job Material to a Transfer Order.....	49
About Job Dates.....	50
Creating a Rework Order.....	52
Releasing and Scheduling the Job.....	53
Releasing a Job.....	53
Scheduling a Job Order.....	54
Issuing Materials to the Job.....	54
Issuing Materials to a Job Order.....	54
Moving Purchased Items from a PO into a Job Operation.....	54
Filtering Job Materials Records.....	55
Sending Job Materials Outside for Processing.....	55
About Outside Process Management.....	55
Setting Up and Using Outside Process Management (OPM).....	58
Setting Initial Parameters for Outside Process Management (OPM).....	58
Outside Process Management: Single Line Example.....	59
Outside Process Management: Multiple Line Example.....	60
Processing the Job on the Shop Floor.....	62
Creating a Job Pick List.....	62
Entering Job Transactions.....	62
About Posted Job Transaction Calculations.....	63
Printing the Job Packet.....	66
Using Co-products and By-products.....	67
About Co-Products and By-Products.....	67
Co-Product Mix Distribution Formula.....	69
About Co-Product Mix Validation.....	69
Changing the Cost Distribution for a Co-Product Mix.....	71
Creating a Co-Product Job Order.....	71
Creating an Estimate Co-product Job.....	72
Creating or Changing a Co-Product Mix.....	73

---

Generating the Job Routing for Co-Product Jobs.....	73
Selecting a Preferred Co-Product Mix for an Item.....	75
About Job Costs.....	75
About Job WIP Costs.....	75
Recovering WIP Costs for a Job Closed Accidentally.....	78
About Planned Costs on a Job.....	79
How Scrap Affects Job Cost.....	80
<b>Chapter 6: Using Production Schedules.....</b>	<b>83</b>
Production Schedules Overview.....	83
Production Schedule Steps.....	84
Creating the Production Schedule.....	84
Creating a Production Schedule Header.....	84
Copying from Another Production Schedule.....	85
Adding Items and Releases.....	85
Entering Production Schedule Items.....	85
Entering Production Schedule Releases.....	86
Processing the Production Schedule on the Shop Floor.....	88
Creating Production Schedule Transactions.....	88
About Production Schedule Posted Transactions.....	89
Updating the Production Schedule Status.....	90
<b>Chapter 7: Using Just-in-Time Production.....</b>	<b>91</b>
Creating JIT Transactions.....	91
<b>Chapter 8: Scheduling Shop Floor Activity.....</b>	<b>93</b>
Scheduling Overview.....	93
Scheduling Steps.....	98
How Event-based Scheduling Works.....	98
Using Scheduler Rules.....	101
Scheduler Batching.....	102
Scheduling Operations.....	103
About Operation Setup.....	103
About Operation Overlapping and Splitting.....	110
Creating Outside Operations.....	115
Calculating Duration for Outside Operations.....	117
Resequencing Scheduled Jobs and Operations.....	118
About Global Priority Settings: Due Date vs. Critical Ratio.....	119
Analyzing Scheduling Output.....	120
Analyzing Scheduler Output.....	120
Using the Resource Gantt Chart on a Windows Client.....	122
Analyzing and Adjusting Resource Gantt Chart Data (Windows Client).....	124

Using the Resource Gantt Chart on a Web Client.....	126
Analyzing and Adjusting Resource Gantt Chart Data (Web Client).....	127
Manually Adjusting the Resource Gantt Chart.....	129
Customizing Scheduling Rules.....	130
Writing a Custom Scheduler Rule.....	130
Writing Custom Job Release Rules.....	162
Writing Custom Resource Allocation Rules.....	164
Writing Custom Selection Rules.....	167
Writing Custom Sequence Rules.....	169
Writing Custom Setup Rules.....	171
Writing Custom Batch Separation Rules.....	173
Writing Custom Batch Release Rules.....	175
Writing Custom Batch Override Rules.....	176
Compiling and Linking Custom Scheduler Rules.....	178
<b>Chapter 9: Recording Status of Shop Floor Activity.....</b>	<b>181</b>
About Shop Floor Transactions.....	181
About Backflushing.....	181
About Backflushing and Control Points.....	183
About Backflushing Labor and Machine Hours.....	185
About Backflushing Materials.....	188
About End of Period Costing.....	190
About Reports For Backflushing.....	194
Reversing a Job Transaction.....	194

---

## Contacting Infor

If you have questions about Infor products, go to the Infor Xtreme Support portal.

If we update this document after the product release, we will post the new version on this website. We recommend that you check this website periodically for updated documentation.

If you have comments about Infor documentation, contact [documentation@infor.com](mailto:documentation@infor.com).





## BOM Bulk Import Forms Overview

Use the BOM Bulk Import forms to integrate between CloudSuite Business and Infor PLM Discrete.

### Forms

- BOM Bulk Import: Use this form to process all XML files within the BOM Bulk Import logical folder.
- BOM Bulk Import Conversions: Use this form to enter a conversion for a source value from the XML to be converted to a different value when writing to the CloudSuite Business column.
- BOM Bulk Import Errors: Use this form to view errors that occurred when the BOM Bulk Import utility was run.
- BOM Bulk Import Mappings: Use this form to define the mapping between the Infor PLM Discrete XML and a predefined set of CloudSuite Business tables (and their columns).
- BOM Bulk Import Parameters: This form contains the parameters used by the BOM Bulk Import utility form.

### Query Forms

- BOM Bulk Import Mappings Query
- BOM Bulk Import Conversions Query
- BOM Bulk Import Errors Query

### Functionality

The BOM Bulk Import forms provide this functionality:

- Allow you to define the mapping between the Infor PLM Discrete BOM XML, and the CloudSuite Business tables/columns (BOM Bulk Import Mappings form).
- Import multiple Current BOMs using a single bulk process (BOM Bulk Import form) with the following capabilities:
  - Run in the foreground.
  - Run in the background.
  - Track errors and allow for viewing errors within CloudSuite Business (BOM Bulk Import Errors form).

- Provide notification when errors occur while processing a BOM/XML file (BOM Bulk Import Errors form).
- When importing a Current BOM:
  - You can flag an item so that when a new Current BOM is imported, the existing current BOM is stored using CloudSuite Business's create revision functionality.
  - The date and time of the import for the item is recorded.
  - Provide the ability to import Reference Designators for materials (set on the BOM Bulk Import Parameters form).

## Using the BOM Bulk Import Utility

The BOM Bulk Import utility processes all XML files within the BOM Bulk Import logical folder. Each XML document contains the current BOM for a single item, so the BOM contained in the XML document is loaded into the current routing/BOM for the top-level item in the BOM XML.

A bom\_seq value must be specified for each incoming material. If an incoming material does not have a bom\_seq value, it is not imported. Existing current materials with a bom\_seq that is not on the incoming XML are deleted. Existing current materials with a bom\_seq that is on the XML are updated. If an incoming material has a bom\_seq not in the current materials, that material is added.

For existing routings, operations are not deleted.

For existing BOMs, materials not in the incoming XML are deleted.

Incoming reference designators are matched to materials using the bom\_seq value.

### Actions Performed

When you click **Process**, the utility processes each XML document in the Bulk Import Logical Folder specified on the BOM Bulk Import Parameters form. For each XML document, this utility performs these actions:

- Reads the document and parses its contents. If a Bulk Archive Logical Folder is specified on the BOM Bulk Import Parameters form, it moves the XML document into this logical folder.
- Loads the data from the XML document into current routing/BOM tables for the top-level item on the XML document.
- Uses the tag definitions as defined on the BOM Bulk Import Parameters form.
- Uses the mapping defined on the BOM Bulk Import Mappings form to map the XML data to the application database tables.
- Uses the conversions defined in the BOM Bulk Import Conversion form to convert data values.
- For top-level items with the **Save Current Revision Upon Import** check box selected on the Items form, and for an inbound BOM that has a new revision, it makes a copy of the item's current routing/BOM.
- Updates the item's **BOM Last Import Date** to the current date on the Items form.

## Errors

If an error occurs, the utility performs these actions:

- Writes the error to the BOM Bulk Import Errors form for the XML file.
- Sends an email to users associated with the publication named BOMBulkImportError on the Publication Subscribers form.
- Does not process the XML file.

## Using the BOM Import Builder

You can use the BOM Import Builder to load a BOM from an external source, such as Infor PLM Discrete, and add operations to it. The BOM is contained in an XML file, which you import using this process:

- Select a logical folder where you want to store the XML file. This folder defaults to the folder that is specified in the **Import/Export Logical Folder** on the Inventory Parameters form.
- Click **Files** to open the File Maintenance form, where you can upload a file to the logical folder.
- Use the **Filename** field to select a file to import. All of the files that are currently in the specified logical folder are listed.
- Click **Load XML** to import the file.

After the BOM file is imported, the information from the BOM displays the parent item in the header and the subordinate items in the **Materials** grid.

On the Operations grid, either enter the operations manually, or select the operation from existing jobs. Clicking **Load Operations** replaces the information in the grid with the operations from the selected job.

**Note:** If any item from the BOM does not currently exist in the item master and the **Create** check box is selected, the system automatically adds the item once you click **Process**.

When you are done adding the operations to the BOM, assign the BOM to a Current Job, Estimate Job, Production Schedule Item, or Production Schedule Release category and click **Process**.

You can then export the BOM as an XML file using the Export Routing BOM utility.

## Creating Routings and Bills of Material

A routing is a group of operations, or steps, that must be done to assemble an item (such as "paint bike frame"-->"attach gear assembly"-->"attach handlebars"). A bill of material (BOM) is the set of materials needed to complete each of the operations (paint, gears, handlebars). The BOM can be multi-level, which means one of the materials required for operation xyz is a subassembly that has its own routing and BOM.

You can add routings and BOMs to an inventory item, job, estimate job, or production schedule using these methods (click on each for detailed steps):

- Adding Routing/BOM Information with Engineering Workbench
- Adding Routing/BOM Information Manually
- Copying Routings/BOMs

**Note:** If the **ECN Use for Job BOM/Routings** inventory parameter is set to **All**, you cannot add or make changes to job materials or operations. If the **ECN Use for Current BOM/Routings** is set to **All**, you cannot add or make changes to current materials or operations. If the **ECN Use for Estimate BOM/Routings** inventory parameter is set to **All**, you cannot add or make changes to estimate materials or operations.

### Current Routing/BOM Notes

When creating a routing (that is, set of operations) and BOM (set of materials) for an item, you must define the operations before you can add materials.

### Job Routing/BOM Notes

The job routing and bill of material (BOM) are required before you can release a job and post transactions for the job (such as issuing materials to the job or moving its finished supply to inventory).

In addition to the above methods, you can copy the current job routing to a new job when you change the job's status to **Released**.

### Production Schedule Routing/BOM Notes

In some previous versions of CloudSuite Business, you were prevented from changing the production schedule item BOM after the system processed a complete or scrap transaction against any release for a production schedule item. Now, provided that no transactions have been posted against that specific release, you can modify the production schedule release routing/BOM using the Production Schedule Release Operations and Production Schedule Release Materials forms, if desired.

After you add routing and bill of material, you can create complete or scrap transactions for the production schedule.

## Adding Routing/BOM Information with Engineering Workbench

You can use the Engineering Workbench to add a routing and bill of material to inventory items (the current routing), production schedules, jobs, or estimate jobs. If you're using the Molding Pack, you can also add a routing and bill of material to co-product jobs or co-jobs.

- 1 To select the transaction:
  - a In the **View** field, select the type of routing/BOM to work with.

- b Click the filter button in the toolbar.
  - c Use the header fields to select the item, job, or production schedule to which you want to add routing/BOM information.
  - d Click the filter button again. Any existing routing information for the item, job, or schedule is displayed.
- 2** To create the routing:
- a In the Operations grid, add a new record for each new operation in the routing. Use the grid fields to select a work center and define operation setup, queue, and run times, as well as the start and end date and other information about the operation.
  - b After adding all the operations for the routing, select **Actions > Save**.
  - c If you need to define resources for an operation beyond the default resource group defined for that operation's work center:
    - Right-click on the operation number in the Operations grid and click **Details**. The appropriate Operations form opens, with the record for this operation displayed.
    - In that form, select the **Resources** tab and define the crew or machine resource groups that this operation requires in order to be processed, as well as parameters related to the resource groups.
    - Save the record and close the form.
  - d If you need to define costs for an operation:
    - Right-click on the operation number in the Operations grid and click **Details**. The appropriate Operations form opens, with the record for this operation displayed.
    - In that form, select the **Costs** tab and define the values used in costing this operation.
    - Save the record and close the form.
- 3** To add materials:
- The Engineering Workbench record containing a new operation must be saved before you can add materials for the operation.
- a In the Materials grid, add a new record. Select an operation for which you want to define a material. Then select or enter the rest of the information about the material. You can add multiple lines defining different materials for a single operation.
  - b Once you have added all the materials for the operations you defined, select **Actions > Save** to save the new materials.

You can now viewing the new routing/materials in the left tree pane of the Engineering Workbench form. The pane contains a tab for each of the available routing/Bills of Material.

To see the new operations or materials you added, either close and reopen the Engineering Workbench form, or click the filter button on the left pane and click **OK** in the dialog that appears. Either method refreshes the tree pane.

The tree display is shown here:

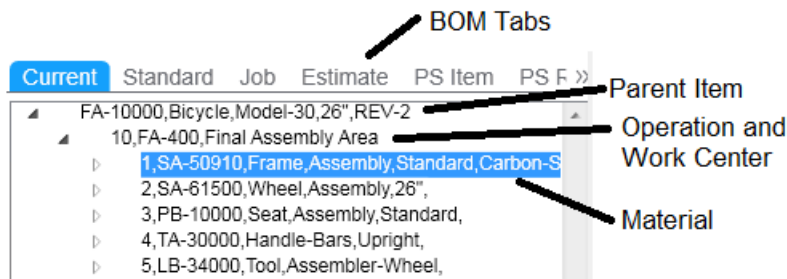

You can collapse the tree display into a simpler view by selecting the (-) symbol next to each item or operation. For example, suppose you want to look at operations for the item, without displaying the materials. Click the (-) symbol next to the operation, and the materials disappear in the collapsed tree. The word "Alternate" appears next to any material that is specified as an alternate material on a current operation.

**Note:** You cannot add or remove operations or items from routing/BOMs in the left pane. Use the right pane of the Engineering Workbench form for maintaining routing/BOMs.

## Adding Routing/BOM Information Manually

This topic describes how to add a routing and bill of material to inventory items (the current routing), jobs, production schedules, or estimate jobs.

**Note:** You can also use the Engineering Workbench form to create and maintain routing/bills of material.

- 1 To create the routing:
  - a Open the appropriate operations form:
    - Inventory Item: Use the Current Operations form.
    - Job: Use the Job Operations form.
    - Co-product Job: Use the **Co-product Jobs** tab of the Job Orders form or the Co-product Job Orders form.
    - Production Schedule Item: Use the Production Schedule Item Operations form.
    - Production Schedule Release: Use the Production Schedule Release Operations form.
    - Estimate Job: Use the Estimate Operations form.
  - b Open the item, job, or production schedule to which you want to add an operation.
  - c Select **Actions > New**.
 

**Note:** Required fields are highlighted in a different color on the form. For a description of a particular field, right-click on the field on the form and select **Help**.
  - d Select the **Standards** tab (if not already displayed). This tab defines operation setup, queue, and run times, as well as the start and end date. Enter data in the appropriate fields.

- e Select the **Resources** tab. This tab defines the crew or machine resource groups that this operation requires in order to be processed, as well as parameters related to the resource groups. Enter data in the appropriate fields.
  - f Select the **Costs** tab. The only values you must enter are the **Setup** and **Labor Run Rates**, which are used in costing the operation. The **Efficiency** field is used for planning, scheduling, and costing.
  - g Select **Actions > Save** to save the operation.
- 2** To add materials:
- a On the operations form, click the **Materials** button to add materials to the operation, if needed. This button opens the appropriate materials form:
    - Inventory Item: Current Materials
    - Job: Job Materials
    - Production Schedule Item: Production Schedule Item Materials
    - Production Schedule Release: Production Schedule Release Materials
    - Estimate Job: Estimate Materials
  - b Select **Actions > New** to add the new material.
  - c Enter the data in the appropriate fields.
  - d Select **Actions > Save** to save the new materials.
- 3** Release release the job or production schedule.

## Copying Routings/BOMs

You can create a new routing and bill of material by copying it from another inventory item (which uses the current routing and BOM), another job, estimate job, or a production schedule item or release.

The settings for the **Preassign Lots** and **Preassign Serials** check boxes on the original job are copied to the new job; however, any preassigned lot or serial numbers are not copied and must be generated for the new job.

## Copying Routings/BOMs with the Copy Routing/BOM or Engineering Workbench

Use either of these forms to copy any type of routing/BOM.

- 1** Open the Copy Routing BOM form. (Or you can use the Engineering Workbenchform's **Copy BOM** button to open this form with the "From" information already filled in.)
- 2** In the **From Category** field, select the type of transaction from which to copy the routing and the bill of material.

**3** Enter the appropriate data in the required fields. The **From Category** you select determines the fields you must enter.

- **Job:** Enter a valid job number when entering a job number to copy from. If copying to, you can either enter a valid job number, a new job number, or leave it blank and let the system create a new job.
- **Sched ID:** Enter a valid production schedule ID when entering a production schedule to copy from. If copying to, you can either enter a valid production schedule ID, a new production schedule ID, or leave it blank and let the system create a new production schedule.
- **Rework:** If the displayed job is a rework order, the **Rework** field will be selected.

**Note:**

- If the target job (or estimate job) displayed in the "To" section of the form is a rework order, you can copy a material to the job BOM that is the same as the job's end item. This recursive BOM structure is allowed only for rework jobs.
- You cannot copy a job structure to a new job if the job BOM contains a sub-job that is a rework order.
- You cannot copy materials from a rework order to a current BOM.
- **Item:** Select the item from which to copy the current routing.
- **Release:** Select the due date of the production schedule release from which to copy the routing/BOM information.
- **Revision:** Enter the revision number of the item.
- **Starting and Ending Operation:** Enter the range of operations to copy. The default will be the starting and ending operation numbers from the job, production schedule, or current routing.
- **Copy Indented BOM:** Default is **No**. Select **Yes** to copy the bill of material and create sub-jobs for any current subassembly materials within the BOM that have a Reference of Job.

**Note:** When you first create the sub-jobs in this manner, the Start and End dates on those jobs will be blank. The next time you run APS Planning, the system will populate these dates based on the current plan data. If you are using MRP, you must run Scheduling to populate the blank dates on the sub-jobs.

- **Extend by Scrap Factor:** Default is **No**. Select **Yes** to use the scrap factor displayed on the Current Materials form as the variable for increasing the quantity on sub-jobs (when the **Copy BOM** field is set to **Yes**).
- **Option:** Select a destination for routings and BOMs being copied or accept the default of Insert.
- **Labor, Material, or Both:** Default is **Both**. This field is used to further define what portion of the routing to copy.
- **After Oper:** Enter the operation number after which to insert the new routing.
- **Effective:** Select a date to copy only non-expired BOMs or accept the default of the current system date.
- **Copy to PS Release BOM:** Select this check box to copy the production schedule item's routing/BOM to any of the production schedule item's releases that do not have a routing/BOM. If the PS item does not contain a routing/BOM, the item current routing/BOM will be copied to the releases. This field is active only if the To Category is set to PS Item.



- 4 In the **To Category** field, select the type of transaction to which you want to copy the routing and BOM. To create a new job from the From information (when the **To Category** is set to **Job**), leave the **Job** field blank.
- 5 Click the **Process** button to start the copy process.

**Note:** If you set the **Copy BOM** field to **Yes**, and you are using the Infinite APS or APS planning mode, the message "[Planning] should be performed" displays. It is not necessary to run APS Planning immediately, but you should run it before the next time you run the Scheduling activity. The copy process may create sub-jobs with blank start and end dates; running APS Planning will populate those dates so the Scheduling activity can run properly. If you are using the MRP planning mode, the message "[Scheduling] should be performed" displays in this situation. With MRP mode, you must run Scheduling to populate the sub-job dates.

## Copying Routings/BOMs with the Job Orders or Estimate Job Orders Forms

The Job Orders and Estimate Job Orders forms allow you to create a new job or estimate routing by copying from the item's current routing. If you are copying from the item current routing, this method is easier than using the Copy Routing/BOM form.

**Note:** This method of copying the routing/BOM does not create sub-jobs for subassembly materials. You must use the Copy Routing/BOM form and enable the Copy BOM field to create sub-jobs automatically.

- 1 Open the desired job.
- 2 Click **Copy Routing/BOM** on the **References** tab.
- 3 Click **OK** at the confirmation message. The system copies the routing from the item current routing to the displayed job.
- 4 Select **Actions > Save** to save the changes to the job.

To update the planned material costs from the Items form, click **Update Planned Costs..**

## Copying Alternate Materials

When you copy an alternate material from a current BOM into another current BOM, the new material in the destination BOM is always created as a primary material. To make the new material an alternate in the destination BOM, change the new material's Alt Group appropriately before you save the new record.

When you copy a current operation into another current routing/BOM, any alternate materials specified in the source operation are copied to the destination BOM as alternate materials. However, when you copy a current operation to any other type of routing/BOM (such as a job or production schedule routing/BOM), alternate materials are NOT copied to the destination BOM.

## How Alternate Materials Are Copied

This topic applies only if you are using the APS planning mode.

It describes how alternate materials are copied when you copy the current routing/BOM in various forms in the system.

### Engineering Workbench

On the Engineering Workbench form, you can copy a material from a current routing/BOM to another routing/BOM. When you copy an alternate material in this manner, it is always copied to the new routing/BOM as a primary material. To make the material an alternate in the new routing/BOM, change the new material's Alt Group number appropriately before you save the new record.

When you copy a current operation from one item to another item, any alternate materials specified in the source operation are copied as alternate materials. However, when you copy a current operation to create any other type of operation (such as a job or production schedule operation), the alternate materials are not copied.

### Copy Routing/BOM

When you copy a current routing/BOM from one item to create a routing/BOM for another item, any alternate materials specified in the source routing/BOM are copied to the new routing/BOM as alternate materials.

When you copy a current routing/BOM to create another type of routing (such as a job or production schedule routing/BOM), the system copies any alternate materials APS selected in the last plan.

### Firming Job Orders and Production Schedule Releases

When you firm a job or production schedule release that APS has planned, and you copy the current routing/BOM, the system copies any alternate materials selected in that last plan. The alternate materials are copied to the new routing/BOM as alternate materials.

When you firm a job or production schedule release that has not been planned, and you copy the current routing/BOM, the system does not copy any alternate materials.

## Exporting a Bill of Material Structure to an XML Document

- 1 Open the Export Routing BOM form.
- 2 Select the type of BOM to be exported from the drop down list in the **From** field. Available options are **Standard BOM**, **Current BOM**, **Estimate Job BOM**, or **Job BOM**.
  - If **From** is **Estimate Job** or **Job**, then specify a job and suffix, which is validated.
  - If **From** is **Standard BOM** or **Current BOM**, then specify an item, which is validated.

- 3** Click **Files** to open the File Maintenance form and specify the logical folder where the XML document will be saved, or accept the default Import/Export Logical Folder that was specified on the Inventory Parameters form.
- 4** Click **Export** to generate the XML document and place it in the logical folder.
- 5** Click **Files** to open the File Maintenance form again.
- 6** Select the XML document and click **Download**; then select the local drive and folder where you want to place the XML file.



## Defining the Work Week

This topic applies to MRP, APS, and the Scheduler. MRP does not use resource shifts; however, it does use the MDAY calendar and Shift ID.

### About Shift Intervals

A shift specifies the set of time periods (called shift intervals) used to determine when resources on that shift are "up" or available to work on operations.

You specify shifts in terms of weeks. This weekly pattern repeats for all weeks within the Scheduling Horizon. A week starts Sunday morning at 00:00:00 and runs until Saturday at midnight. All periods within a week not specified with an interval period are assigned as not working, or down. Daily cycles do not automatically repeat. You must define each daily interval separately.

**Note:** You should never cross Saturday at midnight within a shift interval. If you have a shift that must extend past midnight, you can allow it to do so on other days. But on Saturday, make that shift interval end at 24:00 and create another interval that starts at 00:00.

### How Resources Use Shift Intervals

Resources may use more than one defined shift, and the shifts can overlap. The system considers the resource available during any of its shifts including an overlap period.

When a shift reaches the end of an up interval, resources on that shift become unavailable. By default, any resource currently processing stops processing when its shift goes down.

**Note:** In the Scheduler, the load with the allocated resource uses the resource's Allocation setting to determine whether to wait for the same resource or to try for other resources.

See "Handling Resource Reallocation During Interruptions" on page 31.

If an operation requires multiple resources that are on different shifts, the operation can only be in process when all its required resources are in an up interval. For example, suppose the operation requires three resources:

- Resource A: on-shift from 08:00 - 16:00
- Resource B: on-shift from 10:00 - 18:00
- Resource C: on-shift from 12:00 - 20:00

In this example, the operation could only be in process between 10:00 and 16:00.

### About the Shift and MDAY Calendar

By default, the scheduling shift runs from Sunday to Saturday. Its primary purpose is to determine valid manufacturing or business days, which the system loads into an internal "MDAY calendar" that it reads when running these processes:

- Material Availability Report
- MPS Processor (to determine if a receipt is within the reschedule tolerance factors of a requirement so it can generate a Reschedule exception, and to calculate the date MPS records need to be released by in order to generate a Release Order (MPS Item) exception).
- Material Planner Workbench (when using safety stock or cross-reference method).
- The Forecast form (when calculating forecast consumption by customer orders).

When generating the MDAY calendar, the system reads the Shift ID to determine the valid manufacturing work days. Valid manufacturing days are those where the Minimum Hours in Work Day parameter (defined on the Planning Parameters form) is less than or equal to the total hours in the day on the shift. It enters a day on the MDAY calendar for all of the valid manufacturing days between the MDAY Start and MDAY End dates (also defined on Planning Parameters). The hours specified for each day on the shift determine the total available hours for each day in the MDAY calendar. The system updates the MDAY calendar any time you change the shift or MDAY Start/End or Minimum Hours in Work Day parameters.

You cannot delete the shift.

### About the Lead Time PCAL Shift

By default, APS accumulates lead time for items based on a 24-hour day and 7-day week. If you want to exclude certain days (such as weekend days) from the lead time calculations, you must create a shift named "PCAL" and specify the "working" days. APS ignores days not specified in the PCAL shift when it performs lead time calculations.

### Example Work Week

This example illustrates three typical 8-hour working shifts: 1st, 2nd, and 3rd shift. Each shift overlaps the previous shift by 30 minutes and contains a 30-minute lunch period:

- 1st Shift: 06:00-14:30 Mon-Fri
- 2nd Shift: 14:00-22:30 Mon-Fri
- 3rd Shift: 22:00-06:30 Sun-Thu (the third shift starts the week on Sunday night)

To represent this shift pattern on the Scheduling Shifts form, enter three records as shown in the pictures below:

## 1st Shift

	Starting Day	Starting Time	Ending Day	Ending Time	Must Complete	Allow Overrun
1 (m)	Monday	06:00	Monday	14:00	<input checked="" type="checkbox"/>	<input checked="" type="checkbox"/>
2 (m)	Tuesday	06:00	Tuesday	14:00	<input checked="" type="checkbox"/>	<input checked="" type="checkbox"/>
3 (m)	Wednesday	06:00	Wednesday	14:00	<input checked="" type="checkbox"/>	<input checked="" type="checkbox"/>
4 (m)	Thursday	06:00	Thursday	14:00	<input checked="" type="checkbox"/>	<input checked="" type="checkbox"/>
5 (m)	Friday	06:00	Friday	14:00	<input checked="" type="checkbox"/>	<input checked="" type="checkbox"/>

The first shift starts each day at 6:00 a.m. and ends at 2:30 p.m. However, to account for the 30-minute lunch period, you define it on the form as an 8-hour period rather than 8.5 hours.

After creating the first interval, use **Actions > Copy** to create the remaining intervals in the shift. For example, after creating Monday's shift interval, select **Actions > Copy** and change the Starting Day and Ending Day to Tuesday. Then select **Actions > Copy** again and change the Starting and Ending Days to Wednesday, and so on.

## 2nd Shift

	Starting Day	Starting Time	Ending Day	Ending Time	Must Complete	Allow Overrun
1 (m)	Monday	14:00	Monday	22:00	<input checked="" type="checkbox"/>	<input checked="" type="checkbox"/>
2 (m)	Tuesday	14:00	Tuesday	22:00	<input checked="" type="checkbox"/>	<input checked="" type="checkbox"/>
3 (m)	Wednesday	14:00	Wednesday	22:00	<input checked="" type="checkbox"/>	<input checked="" type="checkbox"/>
4 (m)	Thursday	14:00	Thursday	22:00	<input checked="" type="checkbox"/>	<input checked="" type="checkbox"/>
5 (m)	Friday	14:00	Friday	22:00	<input checked="" type="checkbox"/>	<input checked="" type="checkbox"/>

The second shift starts at 2:00 p.m., 30 minutes before the first shift ends, and runs to 10:30 p.m. Again, you define the shift to end at 10:00 to account for the 30-minute lunch period.

## 3rd Shift

	Starting Day	Starting Time	Ending Day	Ending Time	Must Complete	Allow Overrun
1 (m)	Monday	22:00	Monday	06:00	<input checked="" type="checkbox"/>	<input checked="" type="checkbox"/>
2 (m)	Tuesday	22:00	Tuesday	06:00	<input checked="" type="checkbox"/>	<input checked="" type="checkbox"/>
3 (m)	Wednesday	22:00	Wednesday	06:00	<input checked="" type="checkbox"/>	<input checked="" type="checkbox"/>
4 (m)	Thursday	22:00	Thursday	06:00	<input checked="" type="checkbox"/>	<input checked="" type="checkbox"/>
5 (m)	Friday	22:00	Friday	06:00	<input checked="" type="checkbox"/>	<input checked="" type="checkbox"/>

The third shift starts at 10:00 p.m., 30 minutes before the second shift ends, and runs to 6:30 a.m. the next day. As with the first and second shifts, you define the shift to end 30 minutes earlier to account for the lunch period.

## Defining Shift Exceptions

This topic applies to APS and the Scheduler.

At times you must make exceptions to your basic shift patterns to handle special situations. Shift exceptions help handle many special cases such as:

- working overtime
- reducing the length of a shift
- canceling all work on a shift.

With shift exceptions, you can modify the working availability of a specific resource without having to define new shifts.

Each shift exception is a separate combination of shift, resource, interval, and Work the Shift setting. Shift exceptions are applicable only for resources that are assigned to one or more shifts.

To define a shift exception:

- 1 Open the Resources form.
- 2 Select the resource for which you want to add a shift exception.
- 3 Select the **Shift Exceptions** tab.
- 4 Enter the appropriate information in these fields:
  - **Shift Exception ID:** Enter a unique identifier for this exception. The shift exception ID must be unique across all resources at a given site.
  - **Description:** Enter some descriptive text for the exception.
  - **Start Date:** Enter the effective start date for the exception.
  - **End Date:** Enter the effective end date for the exception.
  - **Work the Shift:** Select **Work** to indicate this exception adds time to the shift. Select **Down Time** to indicate this exception subtracts time from the shift. See the examples in the next section for more information.
  - **Shift ID:** Select the identifier of the shift that this exception applies to. If this is an overtime shift exception, this shift ID must be an additional shift that this resource is not already assigned to (see examples in the next section below). If this is a down time shift exception, this shift ID must be the shift from which you want to subtract working time.
- 5 Save the changes.

## Shift Exception Examples

### Down Time Exceptions

When defining a resource, you specify shifts when the resource is available. You can apply a shift exception to one of those shifts to shorten the shift and reduce resource availability.

Consider this example with two shifts: SHIFT1 and SHIFT2.

- SHIFT1 runs from 07:00 to 15:00 Monday through Friday
- SHIFT2 runs from 15:00 to 23:00 Monday through Friday



- Resources RES1 and RES2 are both available during these shifts

To cancel SHIFT2 for RES1 during the first two weeks of March (but leave it for RES2), you can define a shift exception on the RES1 resource record that:

- runs from 03/01/2008 00:00 to 03/14/2008 24:00
- has the Work the Shift field set to Down Time
- references SHIFT2 in the Shift ID field

This exception makes RES1 unavailable for SHIFT2 during this period.

**Note:** If you leave the **Shift ID** field blank, the shift exception applies to all shifts worked by the resource. In the example, this means SHIFT1 and SHIFT2 for RES1.

## Overtime Exceptions

You can also use a shift exception to increase resource availability. To do so, define the shift exception to apply to both a shift not associated with the resource, and to the resource itself. This extends the resource's shift time and increases its availability.

For example, consider two shifts: SHIFT1 and SHIFT2.

- SHIFT1 runs from 07:00 to 15:00 Monday through Friday
- SHIFT2 runs from 15:00 to 23:00 Monday through Friday
- Resource RES1 is available during these shifts

To add a third shift for RES1 during the first two weeks of March, define SHIFT3 to run from 23:00 to 07:00 Sunday through Friday, and define a shift exception on the RES1 resource record that:

- runs from 03/01/2008 00:00 to 03/14/2008 24:00
- has the Work the Shift field set to Work
- references SHIFT3 in the Shift ID field

This makes RES1 available for SHIFT3 during this period.

## Handling Shift Overrun

This information applies to the Scheduler only.

You may have some operations that cannot be stopped and restarted during shift changes. To ensure that an operation completes before the resource goes off-shift, you can specify that the resource on a specific shift interval must complete the operation it is working on at the end of the shift. Also, you can define a grace period to allow the operation processing to overrun the end of the shift in order to complete.

See "How "Must Complete" and "Allow Overrun" Affect Resource Allocation Decisions" on page 26.

To enable the **Must Complete** and **Allow Overrun** options, follow these steps:

- 1 Open the Resources form and select the resource that can work on the "must complete" operation.

- 2 Select the **General** tab.
- 3 Select the **Must Complete** field.
- 4 (Optional) In the **Maximum Overrun** field, enter the number of hours that this resource may work on the current load beyond the end of a "Must Complete" shift. This value is valid only if the **Allow Overrun** option is selected on the shift interval record.
- 5 Save the changes.
- 6 Open the Scheduling Shifts form. For the **Must Complete** option to have an effect, it must be enabled on both the resource record and on the shift interval record.
- 7 Select the shift interval during which the operation must complete.
- 8 Select the **Must Complete** field.
- 9 If you defined a **Maximum Overrun** value on the resource record, select the **Allow Overrun** field.
- 10 Save the changes.
- 11 Repeat these steps for any other applicable resources and shift intervals.

If the resource cannot finish the entire operation within the Must Complete shift interval, it will wait to start the operation in the next shift interval where it can finish the entire operation (or where the **Must Complete** option is not selected). The Scheduler will try to schedule another operation, in selection rule priority, that can be completed within the available time.

For example, Operation 123 takes 3.25 hours to complete, and is released at 2:00. Operation 456 takes 2 hours to complete, and is released at 2:01. Both operations require resource ABC. Resource ABC has 3 hours of remaining on-shift time, and the Must Complete option is enabled. Therefore, Operation 123 does not allocate the resource and instead enters a request in the resource's request queue. Operation 456 will allocate the resource because it can be completed within the available time. If you had defined the Maximum Overrun for .25 hours, Operation 123 would have allocated the resource, because the resource would have worked the extra .25 hours to complete the operation. The Allow Overrun option must be enabled on the shift record for Maximum Overrun to function.

## How "Must Complete" and "Allow Overrun" Affect Resource Allocation Decisions

The diagram below illustrates how the Scheduler's resource allocation decisions are affected by these options.

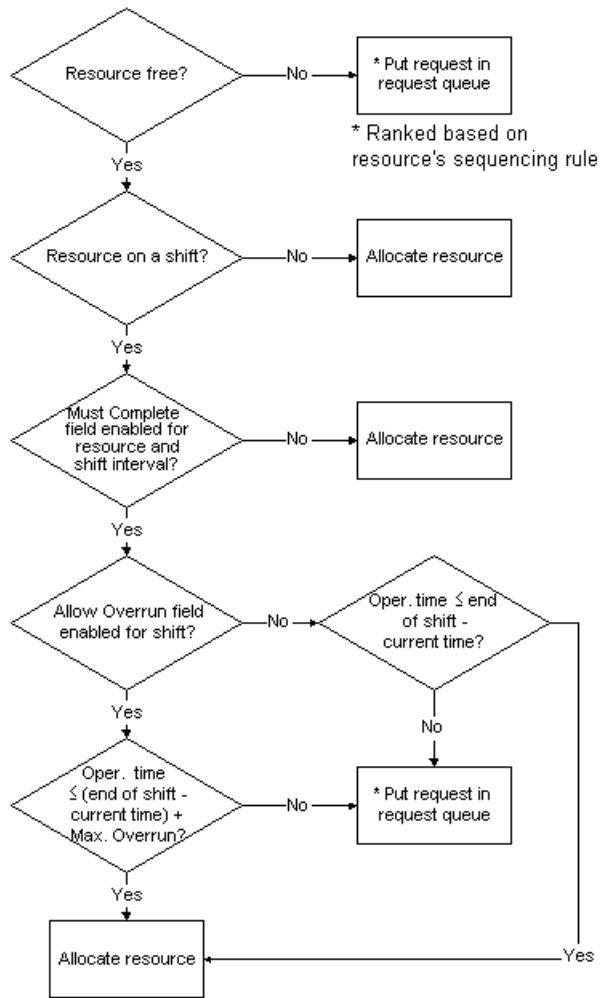



## Resources Overview

When planning and scheduling demands, the system needs an accurate representation of the availability and capacity of your personnel, machines, and other scheduled equipment. You "model" these things in the system using resources. Only APS and the Scheduler constrain their activities using resources. MRP does not use resource availability to constrain its plan. Infinite APS mode considers the on-shift availability of resources but views them as having infinite capacity.

The following components comprise the system resource model:

- Resources
- Resource Groups
- Scheduling Shifts
- Shift Exceptions
- Holidays

**Note:** Work Centers capture all costing information from the scheduling activities but do not otherwise directly affect the schedule.

### Assigning Resources to Groups

An operation specifies one or more resource groups. A resource group is a list of similar resources, such as crew, machines, or fixtures, that can perform the operation. The system selects one or more resources from the group, depending on each resource's availability and on rules you define, to perform the operation.

You can define a resource as a member of more than one resource group. Also, all the members in a resource group need not be from the same resource type.

The operations that require the skills of the resources must reference the appropriate resource groups. When scheduling a job, the system assigns a member resource to perform the operation. To be used, therefore, a resource must be a member of the resource group the operation requests. Each resource should be a member of at least one resource group.

### Assigning Resources to Shifts

Resources are available to perform operations only when they are on-shift (that is, when they are associated with a shift and available to work).

The **Shifts** tab on the Resources form lists all defined shifts on which this resource is available for working. Set up shifts on the Scheduling Shifts form.

Use the **Shift Exceptions** tab on the Resources form to define shift exceptions for this resource (to represent overtime or down time). To delete an out-of-date shift exception from a range of resources and dates, use the Delete Shift Exception utility. To define shift exceptions for all resources in a range of resource groups, use the Shift Exceptions by Group utility.

**Note:** Each shift exception is a separate combination of shift, resource, interval, and Working flag. The shift exception ID must be unique across all resources at a given site.

### Work Shifts and Holidays

To identify the times a resource is available for work, you assign one or more shifts to each resource. To represent down-time or overtime, you can define shift exceptions for a specific resource on a specific shift. You can use holidays to define exceptions in which all resources on all shifts are unavailable.

If an operation requires multiple resources that are on different shifts, the operation can only be in process when all its required resources are in an up interval. For example, suppose the operation requires three resources:

- Resource A: on-shift from 08:00 - 16:00
- Resource B: on-shift from 10:00 - 18:00
- Resource C: on-shift from 12:00 - 20:00

In this example, the operation could only be in process between 12:00 and 16:00.

### Work Interruptions

If an operation is interrupted because the resource goes off-shift, the system can allocate a different resource from the same resource group to take the place of the originally allocated resource.

### About Resource Capacity

With APS and the Scheduler, resources have limited capacity because they may be scheduled only for one operation at a time.

In certain situations and with certain options selected, some or all of your resources can be assumed to have infinite capacity (that is, they can work on an unlimited number of operations at the same time).

### Differences from the PROGRESS Version

The table below summarizes the differences in the resource model from the same types of components in previous versions of CloudSuite Business.

Function	(SQL)	(PROGRESS)
Downtime & overtime	Apply to a specific resource. See "Defining Shift Exceptions" on page 23 for more information.	Apply to the work center.
Multiple resources	Resource groups describe skill sets/functions. Can assign up to six groups to an operation. Can define alternate resources.	Can only model tooling and fixtures as materials.
Multi-skilled resources	Multi-skilled/functional resources can belong to many resource groups. For example, Maria might belong to 3 groups: the Expert Lathe, General Lathe, and General Drilling resource groups.	Cannot model.
Resource allocation	User determines when to free resource. Can substitute resources after interruption. Can assign multiple resources. Can define flexible rules.	Must allocate and free at operation. Can assign multiple tools and crew, but not machines. FIFO rule only.
Splitting loads within operation	Can split loads within operations for all resources. Can specify split size.	Can split only with crew members, but cannot specify split size.
Setup	Fixed value or variable depending on context.	Fixed value only.

## Handling Resource Reallocation During Interruptions

When the Scheduler is processing a load of items on a job, it usually completes an operation and moves on to the next one in the routing. However, certain situations can interrupt the load from being processed at an operation:

- End of a shift
- Start of a shift exception
- Start of a holiday period

Three things happen when the load is interrupted:

- Operation processing for the load stops.
- The resources that have gone off-shift become unavailable.
- All other resources allocated to the load remain allocated.

The system keeps track of each unavailable resource for the load. Once interrupted at an operation, a load must wait to resume operation processing until the system can again allocate all of the load's needed resources.

## Setting Options to Handle Interruptions

You can set options to handle load interruptions as follows:

- Process the load on a substitute resource.
- Reserve the current resource (the one that is now off-shift).
- Place the load back into the resource's request queue.

Use the **Reallocate** option on the Resource Group and the **Allocation Type** on the Resource to control interruptions. The diagram below illustrates the combinations of the two options:

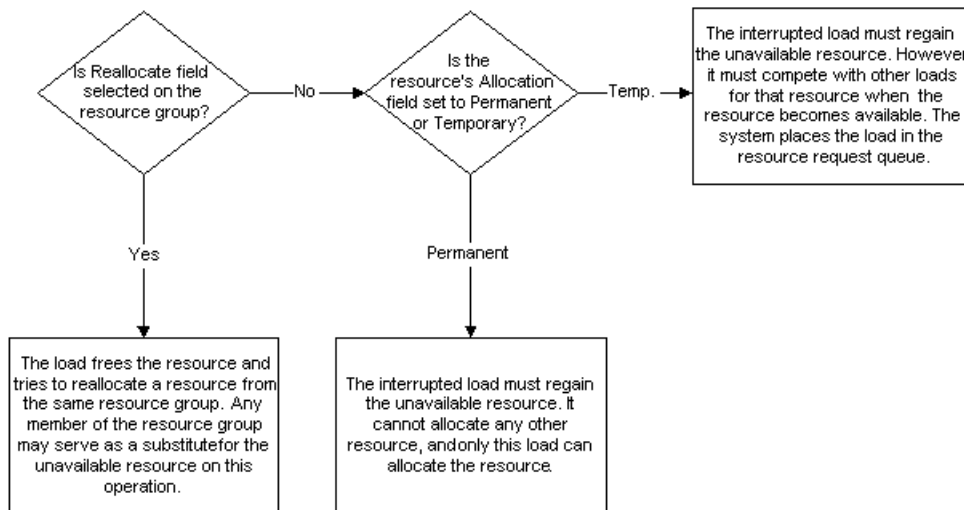

- **Reallocate selected:** The load frees the resource and tries to reallocate a resource from the same resource group. Any member of the resource group may serve as a substitute for the unavailable resource on this operation. The Scheduler does not consider the permanent/temporary state of the resource if **Reallocate** is selected on the resource group.
- **Reallocate not selected:** The load can wait until that specific resource is available. The setting of the original resource's Allocation Type determines whether the load reserves that resource or must compete with other loads to reallocate it.
- **Allocation Type = Permanent:** To resume processing at the operation, the interrupted load must regain the unavailable resource. It cannot allocate any other resource, and only this load can allocate the resource. Reallocation takes place when the resource becomes available, whether reallocation of any other needed resources succeeds or fails.
- **Allocation Type = Temporary:** The interrupted load must regain the unavailable resource to resume operation processing. No other resource can substitute. The interrupted load must compete with other loads for the unavailable resource when it becomes available. The system places the load in the resource's request queue. Reallocation occurs only when the needed resource becomes available and when the interrupted load's request is selected.

**Note:** If one or more of the needed resources belongs to a resource group that has the **Reallocate** field cleared, reallocation is not possible until those resources become available again.

You will usually enable the **Reallocate** field for groups that contain labor resource types working on different shifts, but not for machine resource types.



---

## Entering Indirect Labor Codes

Follow these steps to create a new classification for indirect labor.

- 1 Open the Indirect Labor Codes form.
- 2 Select **Actions > New**.
- 3 In the **Code** field, enter a unique code for the indirect labor classification you are adding.
- 4 In the **Description** field, enter a brief description of the new classification.
- 5 In the **Wage Acct** field, select the number of the G/L account to which to post indirect labor for this classification.

**Note:** The account number you enter in this field must be a valid account number in the Chart of Accounts.

- 6 The unlabeled fields to the right of the **Wage Acct** field represent the unit code segments for the G/L account. For each one that is active, select the unit code for the account.
- 7 Select **Actions > Save** to save the indirect labor code.

## Deleting Indirect Labor Codes

**Note:** Before you can delete an indirect labor code, you must post and purge any job transactions that reference it.

- 1 In the **Code** field on the Indirect Labor Codes form, select the code you want to delete.
- 2 Select **Actions > Delete**.
- 3 When prompted, click **OK** to confirm the deletion.  
The system checks to see if the indirect labor code is used in posted or unposted job transactions; if not, the record is deleted. (The system does not delete the record if a job transaction references the code.)
- 4 Select **Actions > Save** to permanently delete the code from the database.

## Optimizing Resource Selection in the Scheduler

To improve the performance of the Scheduler's processing of a resource request queue, you can try using the following resource selection rules:

- First Load
- First N Loads
- Minimum Setup First Load
- Minimum Setup First N Loads
- Threshold

These rules are faster because they consider only a portion of the possible load requests in the Scheduler's request queue.

Be aware that using these rules can result in unexpected behavior.

For example, situations can occur where the resource becomes free, sorts the request queue using the selection rule, fails to make an allocation, goes idle, and remains idle. In this situation, the resource remains idle until one of the following occurs:

- A load processes an operation where it needs the resource.
- The resource goes off-shift and then back on-shift.

The resource remains idle for the rest of the Scheduler run because another load never needs the resource and the resource is not on a shift. This leads to a related issue. Each time you use the selection rules First Load and First n Loads, load requests at the top of the request queue may "block" load requests further down in the queue. For example, this will occur if:

- First Load is the selection rule for resource RES1.
- The first load in the RES1 request queue requires resources RES1 and RES2.
- RES1 is free, but RES2 is not.

Resource RES1 will remain idle until the system can either allocate RES2 to the waiting load, or another load processes an operation where it needs RES1, or RES1 goes off shift and then back on shift.

## About Infinite Resource Capacity

This topic applies only to APS and the Scheduler.

A resource (whether a crew person, machine, or fixture) with infinite capacity can work on an unlimited number of operations at the same time. The Infinite APS mode of planning assumes all resources to have infinite capacity always (when the resource is on a working shift).

In APS mode and in the Scheduler, resources have finite capacity (they can work on a limited number of operations). However, in some situations, you may want to designate particular resources as infinite. Or you may need to designate a particular item to be planned as though any resource assigned to build it has infinite capacity.

You can specify that resources have infinite capacity in these multiples:

- All resources
- All resources in a resource group
- Single resource
- Any resource when working on a particular item

### All Resources

All resources in all resource groups have infinite capacity during all Infinite APS and APS planning activities when:

- The APS Mode is set to **Infinite APS**. All resources have infinite capacity while they are on a working shift.
- The **Infinite Resource Capacity After** field is in effect at the global level, set on the APS Mode form. This parameter applies only to APS (it is always in effect when the APS Mode is Infinite APS).

## All Resources in a Resource Group

For APS planning and for the Scheduler, you can specify that all resources in a particular resource group have infinite capacity.

For APS, set the **Infinite Resource Capacity After** field that appears on the Resource Groups form. This resource group-level parameter overrides the same parameter defined on the APS Mode form. If the parameter on the APS Mode form is set to four hours, and on the Resource Group it is set to two hours, all resources in that resource group are infinite after two hours.

In Infinite APS mode, this field is disabled and set to 0 hours (that is, resources are always infinite). In APS mode, this field defaults to 999999 hours, and you can change it to another value if desired.

For the Scheduler, select the **Infinite** field on the Resource Groups form to specify that the resource group has infinite capacity while on a working shift. If an operation requires a resource group that is defined as infinite, the scheduling of that operation will be constrained only by times not related to resource availability, such as the operation's Move, Finish, and Run Duration hours (or fixed schedule hours). The Scheduler still selects the resource to perform the operation, and creates appropriate load records. All scheduling rules are still applied, but the Scheduler does not constrain the operation based on other work the resource may have.

**Note:** The Scheduler considers a resource to be finite if it is a member of at least one finite resource group and the **Infinite Scheduling** field on the Resources form is cleared.

## Single Resource

For APS planning, you can specify that a single resource has infinite capacity by selecting the **Infinite Planning** field on the Resources form. This value overrides the **Infinite Resource Capacity After** setting. For example, if the resource is an Infinite Planning resource, and is a member of a resource group that has **Infinite Resource Capacity After** of 999 hours, this resource is considered infinite even if 999 hours have not elapsed.

For the Scheduler, select the **Infinite Scheduling** field on the Resources form to specify that the resource has infinite capacity while on a working shift. If an operation requires an Infinite Scheduling resource, the scheduling of that operation will be constrained only by times not related to resource availability, such as the operation's Move, Finish, and Run Duration hours (or fixed schedule hours). The Scheduler still selects the resource to perform the operation, and creates appropriate load records. All scheduling rules are still applied, but the Scheduler does not constrain the operation based on other work the resource may have.

## Any Resource when Working on a Particular Item

For APS planning, you can specify that a particular item will always be planned as though the resources allocated to build it have infinite capacity. On the Items form, on the **Planning** tab, select the **Infinite APS Item** field. APS plans the item using standard lead time; no resources will be consumed or allocated, and the component items are all needed at the start of this lead time.

## How Infinite Resources Use Shifts

The resource has infinite capacity while in a working ("up") period on a shift. In the Scheduler, the system considers the resource to be infinite if the resource is a member of an Infinite resource group, or is an Infinite Scheduling resource.

## Viewing Resource Utilization Records

Use this form to view the load on your resources for a specified time period and under a specified threshold of utilization. The Scheduler version of this form does not display any information until you run the Scheduling activity. The APS version of this form does not display any information until you run APS Planning.

**Note:** If the **Use Planning Output for Scheduling** planning parameter is selected, the Scheduler version of this form displays the output from running APS Planning instead of the Scheduling activity.

To display the utilization records:

- 1 In the **Start Date** field, select the starting date for the period you want to analyze.
- 2 In the **Intervals** fields, select the method in which to display the utilization records. For example, specify **7** in the first **Intervals** field and select **Days** from the drop-down list to display seven records, each representing a one-day time period.
- 3 In the **Threshold** field, enter a percentage to filter the display by the utilization of the resources. The grid displays records only for resources that have Utilization percentages greater than or equal to the Threshold.
- 4 If desired, select **Exclude Infinite Resources** to exclude all infinite resources from the analysis display. In APS mode, infinite resources are those resources in which the **Infinite Planning** field is selected on the Resources form. In the Scheduler, infinite resources are those resources in which the **Infinite Scheduling** field is selected on the Resources form.
- 5 If desired, you may filter on a specific resource by selecting the resource in the Resource column in the grid.
- 6 Click the Filter-In-Place button to display the utilization records.

Each row in the grid corresponds to a resource and time interval in which the utilization occurs. The rows are sorted by descending utilization (that is, the most critical bottleneck resources are listed first).

After identifying a bottleneck resource, you can select a utilization record and click the **Load Profile** button to launch the Resource Load Profile - Scheduler form or the Resource Load Profile APS form and determine the cause for the over-utilization.

## About Resource Groups

Use a resource group to organize resources that can perform the same function. Then, when you create an operation, you specify one or more resource groups to process the operation. When a load of items

from a job arrives at the operation to be processed, it requests one or more resources from each of its specified resource groups. It does not need a specific resource in the group. The member resources may be working different shifts, have different setups, or have different processing times.

You cannot use a resource group on an operation unless it has at least one resource assigned to it.

**Note:** Resource groups have replaced the work center's scheduling functions as they existed in CloudSuite Business version 6 and earlier. The work center now captures costs only and does not affect the actual planning or scheduling.

## How the Scheduler Assigns Resources

The Scheduler assigns an available resource to the load based on allocation rules you define (such as "choose the resource that has been idle the longest"). Depending on the allocation rules defined, various factors may affect how the Scheduler selects one of the member resources over the others. The **Seq** field on the **Resources** tab is important, especially when using The "Select in Sequence" and "Cyclic" Allocation Rules because they allocate the resource with the lower Seq value first.

See "Using Scheduler Rules" on page 101 for more information.

## How APS Assigns Resources

APS selects resources from the resource group based on the best combination of resources from all resource groups required for the operation. In this case, "best" means the combination that allows the operation to be planned the fastest.

For example, an operation may require 1 resource from labor resource group "Drillers" and 1 from machine resource group "Drill." Each of these resource groups contains five resources that could do the work. The system starts at the top of the list of resources defined for each group and, for each resource, examines information such as shift availability and whether the resource is already busy on other jobs.

The **Seq** field on the **Resources** tab is important because it determines the sequence of the resource list and can affect which resource the system chooses in the case of "ties."

## How to Assign a Specific Resource

To assign a specific resource to work on an operation, create a resource group that contains only that resource. On the Operation record, reference that resource group on the **Resources** tab.

# Viewing Resource Group Utilization Records

To display the utilization records:

- 1 Open the Resource Group Utilization form.
- 2 In the **Start Date** field, select the starting date for the period you want to analyze.

- 3 In the **Intervals** fields, select the method in which to display the utilization records. For example, specify **7** in the first **Intervals** field and select **Days** from the drop-down list to display 7 records, each representing a one-day time period.
- 4 In the **Threshold** field, enter a percentage to filter the display by the utilization of the resources. The grid displays records only for resource groups that have Utilization percentages greater than or equal to the Threshold.
- 5 Scheduler version only: If desired, select **Exclude Infinite Resource Groups** to exclude all Infinite resource groups from the analysis display.
- 6 If desired, select **Exclude Infinite Resource Groups** to exclude resource groups in which the **Infinite Resource Capacity After** field is set to 0.
- 7 If desired, you may filter on a specific resource group by selecting the resource in the Resource Group column in the grid.
- 8 Click the filter-in-place button to display the utilization records.

Each row in the grid corresponds to a resource group and time interval in which the utilization occurs. The rows are sorted by descending utilization (that is, the most critical bottleneck resource groups are listed first).

After identifying a bottleneck resource group, you can select a utilization record and click the **Load Profile** button to launch the Resource Group Load Profile form and determine the cause for the over-utilization.

## Work Centers Overview

You use work centers to capture costs. Work centers do not define planning or scheduling information. The work center may refer to one or more resource groups for setting default planning and scheduling values for that resource group, but a relationship between a work center and resource group is not required.

The Work Centers form allows you to:

- Record information regarding costs and rates associated with a specific work center, including setup, run, fixed machine overhead, and variable machine overhead rates.
- Maintain the default value for account numbers for the Material, Labor, Fixed And Variable Overhead, and Outside Service WIP Accounts for each work center. The overhead rate information is optional.
- Maintain the default value for account numbers for the fixed and variable overhead usage for Material, Labor and Machine Accounts.
- View the accumulated totals of all jobs and production schedules that have passed through the work center since the system was initially set up. Also view the current, cumulative cost for each WIP Account and total WIP per work center for production schedules and JIT production. You update these values manually to reflect your specific time frame.

**Note:** You can define more than one location for a single work center, allowing two items with different locations to be assembled at a common work center.

See "Setting Up Multiple Locations for a Work Center" on page 40 for more information.

## Creating a Department

Use the Departments form to group work centers for applying labor overhead rates and direct labor costs.

- 1 Select **Actions > New** to create a new department.
- 2 Enter the appropriate data in the required fields:
  - Department: Specify a six-character unique identifier composed of numbers, characters, or a combination.

**Note:** The system uses the following default account numbers at the production level for posting transactions (for example, job order).

- Direct Labor Applied Acct: Specify a valid account number for direct labor applied.
- Fixed Ovhd Applied Acct: Specify a valid account number for fixed overhead applied.
- Var Ovhd Applied Acct: Specify a valid account number for variable overhead applied.
- Fix Ovhd Rate: Specify the default fixed overhead rate.
- Var Ovhd Rate: Specify the default variable overhead rate.

**Note:** The system uses the fixed overhead and variable overhead default rates at the production level; for example, job order.

3 Select **Actions > Save** to save the new department.

## Setting Up Multiple Locations/Common Work Center

You can define more than one location for a single work center, allowing two items with different locations to be assembled at a common work center.

For example, if you had an assembly work center that needed to work on two items (for costing purposes), you would need this relationship to be available.

To set up this example relationship:

- 1 On the Locations form, add two locations, L1 and L2, both associated with the AS-500 work center.
- 2 On the Items form, create two items, I1 and I2 (unit of measure = EA and product code = PP).
- 3 On the I1 item record, select the **Backflush** check box.

**Note:** Leave the **Backflush Location** field blank.

- 4 Save the item record.
- 5 Click the **Stock Loc** button to open the Item Stockroom Locations form.
- 6 Add a new item stockroom location for I1 that points to the L1 location. In the **Rank** field, specify **1**.
- 7 On the I2 item record, select the **Backflush** check box.

**Note:** Leave the **Backflush Location** field blank.

- 8 Save the item record.
- 9 Click the **Stock Loc** button to open the Item Stockroom Locations form.
- 10 Add a new item stockroom location for I2 that points to the L2 location. In the **Rank** field, specify **1**.
- 11 On the Job Orders form, create a job.
- 12 Add operation 10 with the work center set to be AS-500.
- 13 Release the job.
- 14 Run the Floorstock Replenishment Report. Both items from different locations are shown on the report.



## Job Steps

You can use jobs, also referred to as manufacturing work orders, to track specific manufacturing processes, including labor, material, machines, cost and scrapped, work in process, and finished goods inventory.

You can follow these steps to track your production using jobs. These are general guidelines; there are several methods and sequences in which to use jobs in the system.

- 1 Create a job order. See "Creating a Job Order" on page 43.

There are many ways to create a job; typically, you firm a planned order into a job.

If you are creating a co-product job order or a co-job order, see "Creating a Co-Product Job Order" on page 71 or the topic on Creating a Co-job Order.

- 2 Define the job routing and bill of materia. See "Creating Routings and Bills of Material" on page 11.
- 3 If necessary, create jobs for any subassemblies in the BOM. See "Creating Sub-Jobs" on page 46.
- 4 Release the job. See "Releasing a Job" on page 53.

At this point for co-job orders, a batch definition is created automatically and referenced back to the job operation.

- 5 Run the Scheduling activity. This activity allows you to generate dispatch lists for the next few days and also fine-tune the job completion dates generated by the MRP or APS Planning activity.
- 6 Print the job packet. See "Printing the Job Packet" on page 66.
- 7 Create a job pick list. See "Creating a Job Pick List" on page 62.
- 8 Enter material transactions on the Job Material Transactions form to issue materials to the job. These transactions are posted immediately when you enter them.

**Note:** To minimize the number of transactions to enter, you can set up selected materials to be issued automatically through backflushing. For more information, see the Backflushing help topics listed in the Related Topics below.

- 9 Enter job operation transactions to record.
  - Setup, move, and run duration
  - Pieces completed or scrapped
  - Materials moved to the next operation
  - Finished goods moved to inventory

- An operation as being complete

**Note:** Job operation transactions are not posted automatically. However, you can backflush labor and/or machine hours on an operation to be posted automatically.

- 10** Post the job operation transactions on the Post Job Transactions form. Any materials you set to backflush on the operations will be posted automatically at this point as well.

# Creating Jobs

## Creating an Estimate Job

An estimate job contains information about the item being quoted, including quantity required and scheduled completion. However, it is not included in actual Shop Floor production schedules.

**Note:** If you are using the Molding Industry Pack and you are creating an estimate co-product job order or an estimate co-job order, see the topics on Creating an Estimate Co-product Job, or Creating an Estimate Co-job.

To create a new estimate job order:

- 1** Open the Estimate Job Orders form and on the toolbar, click the Filter-In-Place button.
- 2** Select **Actions > New**.
- 3** Enter the appropriate data in these fields:
  - **Job:** A unique number, character, or combination. By default, the system uses the next unique number. You can use the suffix to represent a sub-assembly of another job. You can set up a global prefix, **Job Prefix**, on the Shop Floor Control Parameters form to display a sequential number.
  - **(Job Suffix) (optional):** Enter a suffix which identifies this estimate job as a sub-assembly of another estimate job. The estimate job suffix can be turned off by setting the **Job Suffix** flag to **No** on the Shop Floor Control Parameters form. Estimate jobs and jobs can use the same job suffix parameter.
  - **Item:** Enter or select a valid item number for the finished good item.
  - **Rework:** If this is a rework order, select the **Rework** check box. A rework order allows the item you want to repair to be the end item and a component on the job. This recursive BOM structure is allowed only on rework orders.
  - **Job Date:** By default, the system uses the current system date (you do not need to change this field unless you want the job's creation date to be different than today's date).
  - **Status:** Select a status or accept the default of Working.  
See the **Status** field description.
  - **Revision (optional):** Enter the appropriate revision information when an inventory item is affected by an Engineering Change Notice.

- Released: Enter the number of items to be produced for this job.
- Start Date: Enter the start date for the estimate job. The **End Date** field is the date by which it should be completed. The start date is required; the system calculates the end date when you save the job. The projected date is entered automatically when you click the **Get ATP** or **Get CTP** button or when you run the Planning or Scheduling activities.

**Note:** If the start or end date falls on a weekend and Saturday and Sunday are not defined as manufacturing days, the system adjusts the date to reflect a weekday.

**4** Select the **References** tab. Enter the appropriate data in these fields:

- Destination: Select the desired destination type. By default, the system uses Inventory. The system uses this field along with the **Line** field to look up the **Qty Ordered**, **Order Date**, and **Due Date**.
- Parent Job (optional): Enter the parent job number if this estimate job is a sub-assembly of another estimate job.
- Finish Job (optional): Enter the job order number that defines the finished product into which this job's item is to be assembled. By default, the system uses the current estimate job.

**5** To save the new estimate job, select **Actions > Save**.

## Creating a Job Order

The system provides several ways of creating a job order:

- Creating it manually on the Job Orders form.  
See "Creating a Job Order Manually" on page 43.
- Copying an existing job order.  
See "Copying a Job Order" on page 45.
- Firming a planned order into a job.
- Cross-referencing it from a customer order line.
- Cross-referencing it from another job material component.  
See "Cross-referencing a Job Material to a Job" on page 47.
- Using the Copy Routing BOM utility to copy from a routing/BOM or existing job to a new job, using a blank To Job ID.  
See "Copying Routings/BOMs" on page 15.

## Creating a Job Order Manually

This process describes how to create a manufacturing job order manually on the Job Orders form. Only required fields and tips regarding selected optional fields are discussed in this procedure. For

more information, including descriptions of all fields on the form, see the field help topics for the Job Orders form.

**Note:**

- The system provides several methods for creating standard job orders, in addition to this method. See the Related Topics links below.
- If you are creating a co-product job order or a co-job order, see the appropriate topics.

To create a new job order:

**1** Open the Job Orders form and on the toolbar, click the Filter-In-Place button.

**2** Select **Actions > New**.

**3** Enter the appropriate data in these fields:

- **Job:** A ten-character alphanumeric identifier. By default, the system uses the next unique number. If you allow the system to assign the next job number, the job number does not display in the job number field until you save the new job.
- **(Job Suffix) (optional):** Use this field for a four-character suffix to represent a sub-assembly of another job. You can set up a global prefix, **Job Prefix**, on the Shop Floor Parameters form to display a sequential number.
- **Job Date:** Specify the date the job was created. By default, the system uses the current system date. You do not need to change this field unless you want the job's creation date to be different than today's date.
- **Item:** Select an item from the list for the finished good item.
- **Rework:** If this is a rework order, select the **Rework** check box. A rework order allows the item you want to repair to be the end item and a component on the job. This recursive BOM structure is allowed only on rework orders.
- **Status:** Select the status to use for the job order. The default status is Firm.  
For more information, see the **Status** field.  
For a job to have a status of Released, it must have a routing.
- **Revision:** Enter the revision number of the item. The revision number helps you track which, of a number of revisions authorized through Engineering Change Notices, the transaction affects. If the status of the job order is Firm, the **Revision** field must be validated.
- **Released:** Enter the number of items to be produced for this job.
- **For Whse:** Enter the warehouse code for the destination of any finished good inventory this job produces. The default value is the same as that entered in the **Default Whse** field on the Inventory Parameters form.
- **Start and End:** Select the date on which to release this job for work (**Start**) or the date on which you need the job completed (**End**). If you enter a **Start** date, the system plans forward by the item's lead time to arrive at the default **End** date. You can override the default value. If you enter an **End** date, the system plans backward by the item's lead time to arrive at a default **Start** date. The Get ATP/CTP calculation uses the **End** date as the input date to the planning calculations, so make sure the **End** date is the desired job completion date before you click the **Get ATP** or **Get CTP** button.

If the **Start** or **End** date falls on a weekend and Saturday and Sunday are not defined as manufacturing days, the system automatically adjusts the date to reflect a weekday.

The **Projected** date is entered automatically when you click the **Get ATP** or **Get CTP** button or when you run the planning or scheduling activities.

- 4 On the **Scheduling** tab, enter the appropriate data for your order.
- 5 Select the **References** tab. This tab displays reference information about the transaction this job is linked to. If you want to cross-reference this job to a customer order line, parent job, project resource, etc., enter information in these fields:
  - **Destination:** Select the desired destination type. By default, the system uses **Inventory**. The system uses this field along with the **Line** field to look up the **Qty Ordered**, **Order Date**, and **Due Date**. The system also uses it to post the **Ready to Ship** field and to create the Order Entry Cost Variance Report.
  - **Parent Job:** If the job you are creating is a sub-assembly of another job, enter the job number for which this job's item is to be used as a component.
  - **Finish Job:** Enter the job order number that defines the finished product into which this sub-job's item is to be assembled. By default, the system uses the current job.
  - (Optional) If you want to split your work-in-process account into various cost components, select the **Cost Detail** tab. You can identify the components involved in the total cost of a product. The system uses these cost components:
    - Material costs (**Material Cost**)
    - Labor costs (**Labor Costs**)
    - Fixed overhead costs (**Fix Ovhd**)
    - Variable overhead costs (**Var Ovhd**)
    - Outside costs (**Outside**)
- 6 To save the job, select **Actions > Save**.

You can now add a routing and bill of material to the job.

## Copying a Job Order

You can create a new job order by copying an existing one.

- 1 Open the Job Orders form.
- 2 Find a job that has similar characteristics to the job you want to create.
- 3 Select **Actions > Copy**. A new job record is created.
- 4 Make the necessary changes to the job record to create your new job order (for example, job number, start date, and so on).
- 5 Select **Actions > Save** to finish creating the new job.

See "Creating a Job Order" on page 43 or "Creating a Job Order Manually" on page 43.

The setting of the **Preassign Lots** and **Preassign Serials** check boxes on the original job order are copied to the new one; however, any preassigned lot or serial numbers are not copied and must be generated for the new job order.

## Creating Sub-Jobs

Sub-jobs are job orders that launch and track the manufacture of subassemblies within the bill of material for another job order. You can firm the planned order for a subassembly item and create a job for that subassembly. Or you can create sub-jobs that are tied together through their job ID numbers. For example, job for end item might have the ID number 100-0000, job for subassembly A might be 100-0001, and job for the component in the subassembly might be 100-0002.

You might want to create sub-jobs if you need to maintain this job-supply linkage for reference purposes or for visibility on reports such as the Indented Projected Job Cost to Complete report or Consolidated Job Cost report. This topic describes how to create sub-jobs automatically for each subassembly in a bill of material, using a common job ID structure.

### Creating a Sub-Job through Cross-Referencing

You can create an individual sub-job automatically by cross-referencing a job material.

See "Creating a Sub-Job through Cross-Referencing" on page 47.

You can also create sub-jobs for a range of parent jobs through cross-referencing using the Material Planner Workbench Generation. With this method, the parent job must be a scheduled job.

### Generating Sub-Jobs Automatically

To allow the system to create sub-jobs automatically, you can perform one of these tasks:

- Use the Copy Routing/BOM or Engineering Workbench form to copy a routing and bill of material to a job, and select the **Copy Indented BOM** field. See "Copying Routings/BOMs" on page 15 for more information.
- Use the Planning Detail or Material Planner Workbench form to firm a planned order into a job, and select the **Copy Indented BOM** field on the Firm Job dialog.

The system creates a sub-job for any current subassembly material within the BOM that has a Reference of Job (the **Reference** field on the Current Materials form). Generated sub-jobs will use the job number of their parent job + an incremented Job Suffix number. For example, if parent job 142 has two sub-jobs, the sub-jobs will be numbered 142-0001 and 142-0002.

### Managing Sub-Job Start and End Dates

When you create the sub-jobs automatically, as described above, their start and end dates are defined based on the planning mode you are using:

- APS Planner: If the **Use Scheduled Times in Planning** field is not selected, the job start and end dates are sent to the planner for planning. The planner attempts to plan sub-jobs to meet the dates supplied during the copy (instead of "today"). If the **Use Scheduled Times in Planning** field is selected and the job is scheduled, then the scheduled dates are sent to the APS Planner.
- MRP Planning: If the **Use Scheduled Times in Planning** field is not selected, then the MRP Planner uses the job start and end dates initially supplied during the Copy BOM activity. If the **Use Scheduled Times in Planning** field is selected and the job is scheduled, then the scheduled dates (projected) are used.
- APS Scheduler: The APS Scheduler attempts to forward schedule from the job's start date.

See "About Job Dates" on page 50 for more information.

## Finding a Sub-Job's Parent Job

On the Job Orders form, filter to a sub-job and select the **References** tab to view this sub-job's parent job.

The screenshot shows a form with the following fields and values:

- Est Job: [dropdown] 0000
- Parent Job: 142 [suffix] 0000
- Operation: 10
- Seq: 1
- Finish Job: 142 [suffix] 0000

A button labeled "Copy Routing/BOM" is located to the right of the Est Job field. A blue arrow points from the suffix field of the Parent Job to the text "Job # of this sub-job's parent".

## Creating a Sub-Job through Cross-Referencing

You can create an individual sub-job automatically by cross-referencing a job material.

- 1 Use the Job Orders form to create a new job for an item that has subassemblies.
- 2 Select the **References** tab and click the **Copy Current Routing/BOM** button.
- 3 Click the **Materials** button to open the linked Job Materials form.
- 4 Select the job material the sub-job needs to make (the material with a Reference of "Job").
- 5 Select the **Source** tab.
- 6 Click the **Source** button. The sub-job is created with the parent job's number plus an incremented Job Suffix number.

You can also create sub-jobs for a range of parent jobs through cross-referencing using the Material Planner Workbench Generation. With this method, the parent job must be a scheduled job.

## Cross-referencing a Job Material to a Job

Use the Job Materials form to cross reference a job material to an existing job or to create a new job.

- 1 On the Job Materials form, add a new material or select an existing one.
- 2 Select the **Source** tab.
- 3 Make sure **Job** is selected in the **Source** field.
- 4 To cross-reference the job material to an existing job, specify the job number in the unlabeled field next to the **Source** field. In the second unlabeled field, specify the suffix (if available) for the job order. In the third unlabeled field, specify an operation number to cross-reference to a specific operation.

To create a new job and assign a particular job number, specify the job number. To create a new job and allow the system to assign a job number, leave the field blank (the system will use the same job number as the parent job, but will increment the suffix number).

**5** Click the **Source** button. The system creates a job order that is cross-referenced to the job material and inserts the job number and suffix into the **Source** field.

**6** Optional: You can click **Source** again to display the cross-referenced job order.

**Note:** You can cross-reference to a range of jobs using the Material Planner Workbench form.

After a cross-reference is created, you can change it by either removing the line item or changing the cross-reference information, thus deleting the cross-reference. When this happens, the system displays a warning message to indicate that the cross-reference will be unlinked.

To view unlinked references, you can filter on the **Unlinked Reference** check box. You can then do one of the following:

- Clear the **Unlinked Reference** check box so that the record is no longer unlinked. There is no indication in the system that the record was ever cross-referenced.
- Delete the supply record.
- Leave the **Unlinked Reference** check box selected.

## Cross-Referencing a Job Material to a PO Requisition

Use the Job Materials form to cross reference a job material to a purchase order requisition.

**1** On the Job Materials form, add a new material or select an existing one.

**2** Select the **Source** tab.

**3** Make sure **Requisition** is selected in the **Source** field.

**4** To cross-reference the job material to an existing PO requisition, specify the PO requisition number in the unlabeled field next to the **Source** field. In the second unlabeled field, specify the PO req line number (or leave it blank to create a new line on this PO requisition).

To create a new PO requisition and assign a particular PO requisition number, specify the PO requisition number. To create a new PO requisition and allow the system to assign a PO requisition number, leave the field blank.

**5** Click the **Source** button. The system creates a PO requisition and line that is cross-referenced to the job material and inserts the PO requisition number into the **Source** field.

**6** Optional: You can click **Source** again to display the cross-referenced PO requisition line.

**Note:** You can cross-reference to a range of PO requisitions using the Material Planner Workbench form.

After a cross-reference is created, you can change it by either removing the line item or changing the cross-reference information, thus deleting the cross-reference. When this happens, the system displays a warning message indicating the cross-reference will be unlinked.

To view unlinked references, you can filter on the **Unlinked Reference** check box. You can then do one of the following:

- Clear the **Unlinked Reference** check box so that the record is no longer unlinked. There is no indication in the system that the record was ever cross-referenced.
- Delete the supply record.



- Leave the **Unlinked Reference** check box selected.

## Cross-Referencing a Job Material to a Purchase Order

Use the Job Materials form to cross reference a job material to a purchase order.

- 1 On the Job Materials form, add a new material or select an existing one.
- 2 Select the **Source** tab.
- 3 Make sure **Purchase Order** is selected in the **Source** field.
- 4 To cross-reference the job material to an existing purchase order, specify the PO number in the unlabeled field next to the **Source** field. In the second unlabeled field, specify the PO line number (or leave it blank to create a new line on this PO).
- 5 Save the record to enable the **Source** button.
- 6 Click the **Source** button. The system creates a purchase order and purchase order line that is cross-referenced to the job material and inserts the PO number into the **Source** field.
- 7 Optional: You can click **Source** again to display the cross-referenced purchase order line.

To create a new purchase order and assign a particular PO number, specify the PO number. To create a new purchase order and allow the system to assign a PO number, leave the field blank.

**Note:** You can cross-reference to a range of purchase orders using the Material Planner Workbench form.

After a cross-reference is created, you can change it by either removing the line item or changing the cross-reference information, thus deleting the cross-reference. When this happens, the system displays a warning message indicating the cross-reference will be unlinked.

To view unlinked references, you can filter on the **Unlinked Reference** check box. You can then do one of the following:

- Clear the **Unlinked Reference** check box so that the record is no longer unlinked. There is no indication in the system that the record was ever cross-referenced.
- Delete the supply record.
- Leave the **Unlinked Reference** check box selected.

## Cross-referencing a Job Material to a Transfer Order

Use the Job Materials form to cross reference a job material to an existing transfer order or to create a new transfer order.

- 1 On the Job Materials form, add a new material or select an existing one.
- 2 Select the **Source** tab.
- 3 Make sure **Transfer** is selected in the **Source** field.

- 4 To cross-reference the job material to an existing transfer order, specify the transfer order number in the unlabeled field next to the **Source** field. In the second unlabeled field, specify the transfer order line number (or leave it blank to create a new line on this transfer order).

To create a new transfer order and assign a particular transfer order number, specify the transfer order number. To create a new transfer order and allow the system to assign a transfer order number, leave the field blank.

- 5 Click the **Source** button. The system creates a transfer order that is cross-referenced to the job material and inserts the transfer order number into the **Source** field.
- 6 Optional: You can click **Source** again to display the cross-referenced transfer order.

**Note:** You can cross-reference to a range of transfer orders using the Material Planner Workbench form.

After a cross-reference is created, you can change it by either removing the line item or changing the cross-reference information, thus deleting the cross-reference. When this happens, the system displays a warning message indicating the cross-reference will be unlinked.

To view unlinked references, you can filter on the **Unlinked Reference** check box. You can then do one of the following:

- Clear the **Unlinked Reference** check box so that the record is no longer unlinked. There is no indication in the system that the record was ever cross-referenced.
- Delete the supply record.
- Leave the **Unlinked Reference** check box selected.

## About Job Dates

You can create manufacturing job orders by creating them manually on the Job Orders form, by cross-referencing from a customer order line, by firming a planned order, or by running the Copy Routing/BOM utility. A job order has a Start and End date that the system calculates or you enter manually depending how you create the job:

- When you create a job manually, you must enter either a Start or End date.
- When you firm a planned order into a job, the Start and End dates are determined by the completion date MRP or APS projected for the planned order.
- When you create sub-jobs automatically (by copying a current routing/BOM to a job or by firming a planned order and copying the indented BOM) their Start and End dates are populated based on the parent job's start date and lead times.

The Start and End dates may determine when the system plans the job's materials and are used as input values to the Scheduling activity's calculations.

The job also has a **Projected Date**, which the APS Planning activity or Scheduling activity calculates based on the latest plan information. Depending on the setting of the **Planning Analysis for Non-Scheduled Jobs** parameter, you will use either the Start/End dates or the **Projected Date** for your output analysis activities.

This topic describes how the system updates a job's Start, End, and Projected dates differently depending on how you created the job and depending on the planning mode you are using. It also describes how the system uses these dates on the output forms and reports.

## How Job Dates Are Set in APS Mode

The APS Planning activity calculates job dates as follows:

- For jobs with blank Start and End dates, APS populates the Start and End dates based on the current, latest plan data (unless you manually entered dates for the job on the Job Orders form).
- For any unscheduled jobs, APS populates or updates the Projected date based on the current, latest plan data.

The Scheduling activity populates or updates the Projected date, but never populates the Start and End dates.

The table below summarizes the conditions when APS Planning or the Scheduling activity updates the job dates.

Date	APS Planning	Scheduling
Start/End	Updates if dates are blank	Never updates (because the APS Planning activity will already have populated the Start and End dates)
Projected	Updates if job is not Scheduled	Updates

## How Job Dates Are Set in MRP Mode

MRP Planning does not populate a job's blank Start and End dates, nor does it modify existing Start and End dates. MRP also does not populate or modify a job's Projected date field. If you are using MRP, you must run the Scheduling activity to populate any of the job dates.

The table below summarizes the conditions when MRP Planning or the Scheduling activity updates the job's dates.

Date	MRP Planning	Scheduling
Start/End	Never updates	Updates if dates are blank and job was completely scheduled
Projected	Never updates	Updates

## How Job Dates Are Presented on Output Forms and Reports

Either the job's Start and End dates or the **Projected Date** may appear with the job on output forms (such as Planning Detail and Material Planner Workbench) and reports (such as the Order Action Report), depending on the following conditions:

- The Planning mode you are using (APS or MRP)
- Whether the job is scheduled

- The setting of the planning parameters **Use Scheduled Times in Planning** and **Planning Analysis for Non-Scheduled Jobs**.

The table below summarizes the conditions that determine how output forms and reports display job dates when you are using APS mode.

Job Scheduled?	Use Scheduled Times in Planning	Planning Analysis for Non-Scheduled Jobs	Dates Used
No	No	Use Job End Date	Job Start/End
No	No	Use Projected Date	Projected date
No	Yes	Use Job End Date	Job Start/End
No	Yes	Use Projected Date	Projected date
Yes	No	Use Job End Date	Job Start/End
Yes	No	Use Projected Date	Projected date
Yes	Yes	Use Job End Date	Projected date
Yes	Yes	Use Projected Date	Projected date

In MRP mode, if the job is not scheduled, the job's Start and End dates are always used on the output forms and reports.

If the job is scheduled, the **Use Scheduled Times in Planning** parameter determines which dates are used. If **Use Scheduled Times in Planning** is selected, the job's **Projected Date** is used. If **Use Scheduled Times in Planning** is cleared, the job's Start and End dates are used.

## Creating a Rework Order

To repair an item that you have received through a return material authorization (RMA), you create a rework job order (or estimate job order). The rework order's bill of material includes the item as the end item and as a component. This recursive BOM structure is allowed only on a bill of material for a rework order.

After receiving a returned, defective item (through an RMA return transaction), follow these steps to create a rework order and repair the item:

- 1 Open the Job Orders (or Estimate Job Orders) form and create a new order. We recommend you decide on a special prefix to use in the job numbers for rework orders. Using a special prefix will allow you to filter your job reports to include only rework orders, if necessary.
- 2 In the **Item** field, select the returned item that you want to repair.
- 3 Select the **Rework** field. Selecting this field will allow this job's bill of material to be recursive.
- 4 Enter or select the appropriate values for the job in the remaining fields as desired.
- 5 Enter the job operations (click the **Operations** button to open the Job Operations form).
- 6 Define the job bill of material (click the **Materials** button to open the Job Materials form). Enter the item to be repaired as a component, along with any other materials necessary for the repair.

- 7 On the Job Material Transactions form, issue the item to be repaired (from its non-nettable location where you originally received the RMA order) to the rework order.
- 8 Issue any other needed materials to the rework order.
- 9 Enter job operation transactions to record setup, labor or machine time, and overhead, and to move the completed, reworked item to inventory.

**Note:**

- Only job orders and estimate job orders can be rework orders. You can also create a rework job order on the Engineering Workbench form (if you copy an estimate job to a job and the estimate job is a rework order).
- When defining the bill of material for the rework order, the rework item can be recursive only two levels down in the BOM. For example, if end-item A is made from material B, A and B can be the same item. However, if A is made from B and B is made from C, C cannot be the same item as A.
- Once you add a recursive BOM to the rework order, you cannot clear the **Rework** field on that job or estimate job (that is, you cannot change the rework order back into a normal job or estimate job).
- When issuing the returned material to the rework order, you must enter the job material transaction on the Job Material Transactions form. You cannot use backflushing and you cannot use the **Post Material Issues** option on the **Job Pick List** report.
- For MRP and APS planning, the end item of the rework order is considered as a planned supply/receipt. The same (recursive) item in the bill of material is not considered as a demand/requirement. If the rework order has no routing/BOM, MRP and APS ignore the rework order completely.
- If you use Standard costing for a rework item, you may encounter large routing and/or material usage variances, because the routing and materials used to repair the item may vary greatly from those used to build the original item.
- If a job is marked as Rework, the lot and serial preassignment fields are disabled.

## Releasing and Scheduling the Job

### Releasing a Job

There are two ways to release a job:

- You can release a job by updating the **Status** field on the firm job order to **Released**.  
If no operations exist for this job when you save the job, you see the message, "Copy Current BOM will be performed." Click **OK** to copy the routing from the item current routing or the co-product mix routing to the displayed job. After you run MRP Planning, APS Planning, or click the **Get ATP/CTP** button on the job, the plan will be based on the newly created job routing/BOM (until you run one of these planning activities, the plan is based on the current routing/BOM).

**Note:** This method of copying the routing/BOM does not create any jobs for subassemblies within the BOM. To create these sub-jobs automatically during the copy routing/BOM process, you must use the Copy Routing/BOM form and select the **Copy Indented BOM** field.

- You can also release a job using the Job Status Change/Delete utility. This utility can also delete History Jobs.  
Enter the appropriate status in the **From Job Status** and **To Job Status** fields, which are required.

## Scheduling a Job Order

Job orders with status Released are scheduled automatically when you run the Scheduling activity.

For job orders with status **Firm** to be scheduled, you must select the **Schedule Firm Jobs** option, on the Scheduling Parameters form, before running the Scheduling activity.

## Issuing Materials to the Job

### Issuing Materials to a Job Order

To issue materials required for a job order, you can use either of these methods:

- Enter a job material transaction. You must use this method if you need to manually move all inventory that is either lot or serial tracked.
- Set up backflushing for selected materials. This method allows you to minimize the number of transactions to enter because the materials are issued automatically. The system tracks all actual labor, material, and WIP costs through the routing.

### Moving Purchased Items from a PO into a Job Operation

Use the Post Job WIP Move Transactions form to move purchased items from a purchase order into a job operation or to move finished goods into inventory.

- 1 On the Post Job WIP Move Transactions form, enter the job number in the **Job** field.
- 2 In the **Oper** field, enter the operation number of the parent job order for which this job order's item is to be used as a component.
- 3 Select the date on which the work associated with the transaction was performed in the **Transaction Date** field.
- 4 Enter the quantity of goods completed at the operation as a result of the work performed in the **Completed** field.
- 5 Enter the quantity scrapped during the job transaction in the **Scrapped** field.
- 6 Enter the quantity of goods moved to stock or on to the next operation in the **Moved** field.

- 7 Enter the next operation number to which you are moving the material in the **Next Oper** field.
- 8 Select a reason code in the **Reason** field.
- 9 Enter the stock location in the **Location** field.
- 10 Enter the lot number in the **Lot** field.
- 11 Select the appropriate options:
  - Complete?: Select this option to indicate that this operation has been completed.
  - Close Job?: Select this option to close the job after posting this transaction. This field is active only when goods are being moved to stock
  - Issue to Parent?: Select this option to issue material directly to a job work in process (WIP).
- 12 Click the **Process** button.

## Filtering Job Materials Records

If the job you are working with has hundreds or thousands of materials, it may be difficult to find a particular material. To further filter the display:

- 1 After selecting the job you want to work with, click the filter-in-place toolbar button. These fields become active, allowing you to filter within the displayed job by these fields:
  - Operation
  - Sequence
  - Item
  - Item Description
- 2 Enter your additional filter criteria in one or more of the above fields and click the filter-in-place button again. All job materials where the **Quantity Issued** < **Quantity Required** and that match your filter criteria are displayed in the grid.

## Sending Job Materials Outside for Processing

### About Outside Process Management

Use Outside Process Management to track and ship materials from a standard CloudSuite Business job to a vendor for plating, finishing, painting, or any other service.

With OPM, you can specify an operation on a job as an outside service. When the job items are moved into that operation for an outside work center where the cross-reference is set to a purchase order, the system creates a PO for the service to be performed (if a PO is not already cross-referenced). The

system also creates records that identify which items to ship to certain vendors. You can then print packing slips and ship the items from the Vendor Shipping form.

When the vendor completes the outside service, use standard purchase order receiving to receive the items back into the job.

### **OPM Process Flow**

This diagram shows the process flow for outside process management.



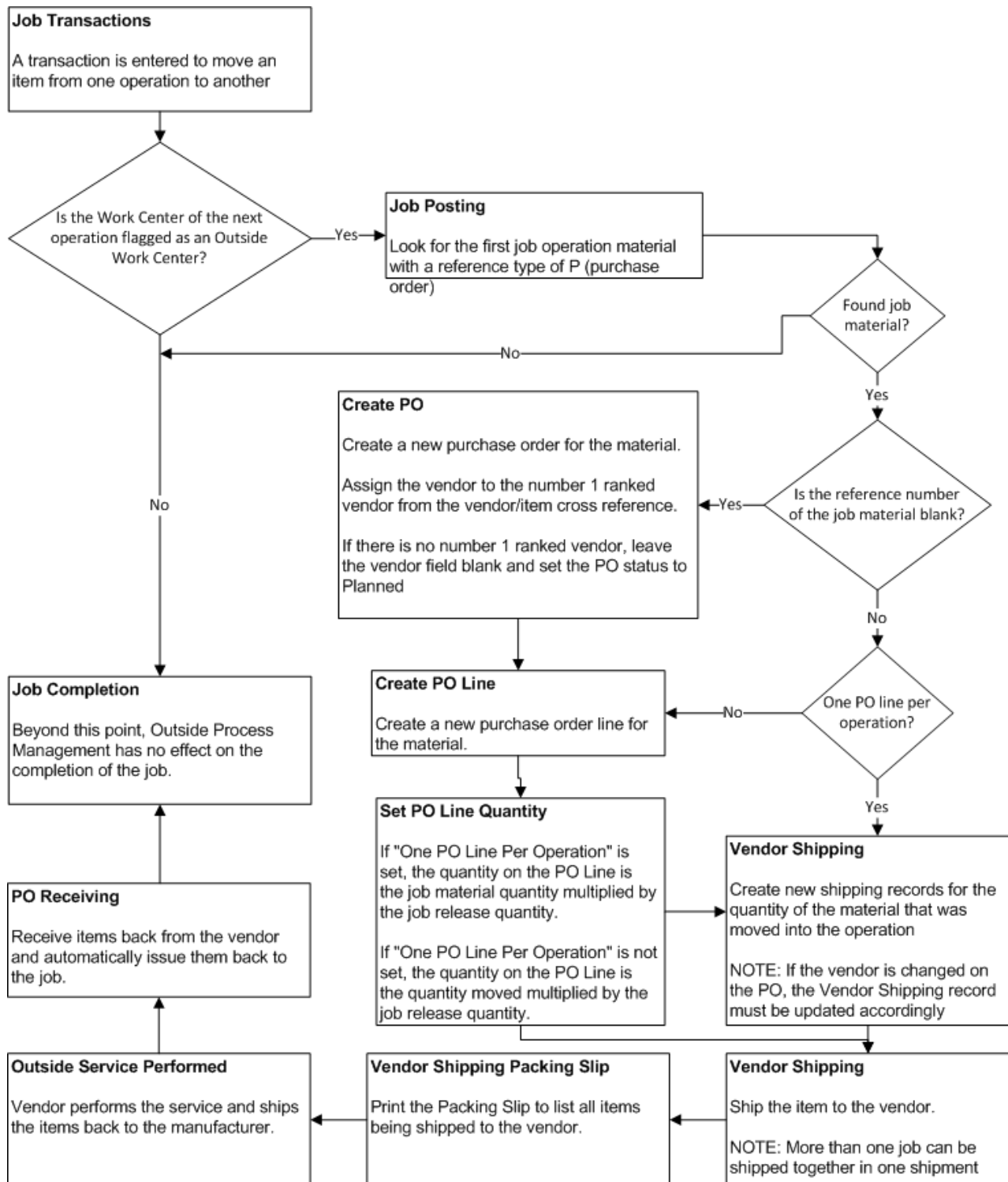

## OPM Examples

Use the related examples to better understand how to set up and use Outside Process Management for outside job operations. These examples show the two methods available for handling quantities for the job. When you move the job item into the outside operation, a PO is automatically created, and records are created that identify which items must be shipped to certain vendors. After the outside service is completed by the vendor, the items are received back into the job through the purchase order receiving.

## Setting Up and Using Outside Process Management (OPM)

### Initial Setup of Parameters

See "Setting Initial Parameters for Outside Process Management (OPM)" on page 58.

### Job Operation Setup

To set up a job to go through outside process management, create an operation for an outside work center. Under that operation, create a Job Materials record for an item that will make sense to your vendor. This item is used on the purchase order and the Vendor Shipping form. Set the cross-reference type to purchase order; otherwise, OPM does not recognize the records. You can complete cross-referencing at this point, to set up the purchase order header and line record for the outside process.

### General Process

When an item is received into the operation that you defined above, the cross-reference is checked:

- If the **PO Item Xref Method** on the Shop Floor Control Parameters form is set to **One Line** and the cross-reference is not specified, OPM creates the purchase order and line for the full quantity required by the operation.
- If **PO Item Xref Method** is set to **Multiple Lines**, OPM creates a new line for the quantity that was just received into the operation.

No matter which option is used, a vendor shipping record is created, or an outstanding shipment is updated with the new quantity that is waiting to be shipped to the vendor. If the purchase order vendor is changed, the related shipping records also change.

You can create vendor packing slips for all the parts to be shipped to various vendors. Use the Vendor Shipping form to ship the parts to the vendor to be processed. Run the Item At Vendor Report to see what was shipped to a vendor but is not yet returned. When the items are returned from the vendor, use the PO receiving features to receive the items and issue them to the job.

## Setting Initial Parameters for Outside Process Management (OPM)

On the Shop Floor Control Parameters form, perform these steps:

- 1 Select **Enable Outside Process Management**.
- 2 In the **PO Item Xref Method** field, specify the method to use:
  - **One Line**: When job transactions are posted, only create one PO line with a quantity equal to the quantity released on the job.
  - **Multiple Lines**: For each instance where a job transaction is posted, create a separate PO line with a quantity equal to the quantity of the transaction.
- 3 Specify a **PO Status** default value of **Planned** or **Open**.
- 4 Specify the **PO Due Date Calculation** default method: **Oper End Date** or **Oper Fixed Sched Hours**.
- 5 Select **Base Job Consolidation** to create separate lines for each sub-job within the same purchase order, or clear this field to create separate purchase orders for each sub-job.
- 6 Select **Check for Consecutive Operations** to create one purchase order, with a line for each operation, for consecutive job operations going to the same vendor when users perform a job move transaction.

If this field is cleared, a separate purchase order is created for each job move transaction

## Outside Process Management: Single Line Example

In this example, when job transactions with outside operations are posted, one PO line is created with a quantity equal to the quantity released on the job.

- 1 On the Shop Floor Control Parameters form, specify this information:
  - Select **Enable Outside Process Management**.
  - Select **One Line** in the **PO Item Xref Method** field.
  - Select **Planned** as the **PO Status** default value.
  - Select **Oper End Date** as the **PO Due Date Calculation** default method.
- 2 On the Work Centers form, find or create a work center that has outside processing enabled on the **Scheduling** tab. Note the ID.
- 3 On the Job Orders form, create a new job with a release quantity and a status of Released.

**Note:** If the selected item has a standard bill of material already set up, you are prompted whether to copy the current BOM. Either copy the BOM or set up job operations manually in the next step.
- 4 On the Job Orders form, click **Operations**.
- 5 On the linked Job Operations form, add three operations. The second operation uses the work center specified above.
- 6 In the **End Date** field, specify a date for the operation that uses the outside process.
- 7 Click **Materials** from the second operation that you created.
- 8 In the linked Job Materials form, create a new record and ensure that the reference on the **Xref** tab is set to **Purchase Order**.

**Note:** If Copy BOM was used, ensure that an operation for an outside process exists and note the operation number.

- 9 On the Unposted Job Transaction form, create a new record and specify this information:
  - Transaction Type: Select **Run**, **Move**, or **Machine** to activate the **Completed** field as needed for this example.
  - Transaction Date: This field is defaulted to the current date.
  - Job: Specify the job number created earlier.
  - Operation: Specify the operation number prior to the outside process operation. For example, if the job you created has 3 operations 10, 20, and 30, and the outside process operation is operation 20, specify operation 10 for the unposted job transaction.
  - Completed: Specify a quantity that is less than the released quantity for the job. The quantity can be less than but cannot be more than the quantity released from the job order.
  - Moved: When you tab out of the **Completed** field, this field is defaulted to the Completed value.
  - Total Hours: Specify the total number of hours.
- 10 On the Post Job Transactions form, select **Post Complete Transactions**.
- 11 Specify the job number from the previous steps and click **Process**.
- 12 When you receive the "Post Job Transactions will be performed" message, click **OK**.
- 13 Verify that the "Post Job Transactions was successful" message is displayed and click **OK**.
- 14 On the Job Materials form, the **Xref** tab and **Reference** field are now populated with a purchase order and line number. Click **Xref** to view the linked Purchase Order Lines form.

The quantity on the PO line should be the same as the released quantity of the job, based on the **One Line** parameter selected above.

The due date of the PO line should match the end date specified for the associated job operation. This is based on the parameter selected above.
- 15 On the Vendor Shipping form, select the vendor from the created purchase order. The available shipping records are displayed in the grid.
- 16 Click **Ship Line** to process an individual record or click **Ship Batch** to process all available records.
- 17 After the outside service is completed, the vendor sends back the materials. Use the Purchase Order Receiving form to process the received materials. This process also calls the Job Material transaction and the Post Job WIP Move transaction in order to update the job records.

**Note:** The PO and line status must be changed to Open in order to perform the receipt. The status defaulted to planned based on the parameter you selected above.

## Outside Process Management: Multiple Line Example

In this example, for each instance when a job transaction with an outside operation is posted, a separate PO line is created with a quantity equal to the quantity of the transaction.

- 1 On the Shop Floor Control Parameters form, specify this information:
  - Select **Enable Outside Process Management**.
  - Select **Multiple Lines** in the **PO Item Xref Method** field.
  - Select **Open** as the **PO Status** default value.

- 
- Select **Oper Fixed Sched Hours** as the **PO Due Date Calculation** default method.
- 2** On the Work Centers form, find or create a work center that has outside processing enabled on the Scheduling tab. Note the ID.
  - 3** On the Job Orders form, create a new job with a release quantity and a status of Released.  
**Note:** If the selected item has a standard bill of material already set up, you are prompted whether to copy the current BOM. Either copy the BOM or set up job operations manually in the next step.
  - 4** On the Job Orders form, click **Operations**.
  - 5** On the linked Job Operations form, add three operations. The second operation uses the work center specified above.
  - 6** In the **Fixed Sched Hours** field, specify a date for the operation that uses the outside work center.
  - 7** Click **Materials** from the second operation that you created.
  - 8** In the linked Job Materials form, create a new record and ensure that the reference on the **Xref** tab is set to **Purchase Order**.  
**Note:** If Copy BOM was used, ensure that an operation for an outside process exists and note the operation number.
  - 9** On the Unposted Job Transaction form, create a new record and specify this information:
    - Transaction Type: Select **Run**, **Move**, or **Machine** to activate the **Completed** field as needed for this example.
    - Transaction Date: This field is defaulted to the current date.
    - Job: Specify the job number created earlier.
    - Operation: Specify the operation number prior to the outside process operation. For example, if the job you created has 3 operations 10, 20, and 30, and the outside process operation is operation 20, specify operation 10 for the unposted job transaction.
    - Completed: Specify a quantity that is less than the released quantity for the job. The quantity can be less than but cannot be more than the quantity released from the job order.
    - Moved: When you tab out of the **Completed** field, this field is defaulted to the Completed value.
    - Total Hours: Specify the total number of hours.
  - 10** In the Post Job Transactions form, select **Post Complete Transactions**.
  - 11** Specify the job number from the previous steps and click **Process**.
  - 12** When you receive the "Post Job Transactions will be performed" message, click **OK**.
  - 13** Verify that the "Post Job Transactions was successful" message is displayed and click **OK**.
  - 14** On the Job Materials form, the **Xref** tab and **Reference** field are now populated with a purchase order and line number. Click **Xref** to view the linked Purchase Order Lines form.  
The quantity on the PO line should be the same as the completed quantity of the job transaction, based on the **Multiple Lines** parameter selected above.  
The due date of the PO line should match the value of the fixed schedule hours of the operation as assigned above. This is based on the parameter selected above.
  - 15** On the Vendor Shipping form, select the vendor from the created purchase order. The available shipping records are displayed in the grid.
-

**16** Click **Ship Line** to process an individual record or click **Ship Batch** to process all available records.

**17** After the outside service is completed, the vendor sends back the materials. Use the Purchase Order Receiving form to process the received materials. This process also calls the Job Material transaction and the Post Job WIP Move transaction in order to update the job records.

## Processing the Job on the Shop Floor

### Creating a Job Pick List

Use the Job Pick List form to select materials to be picked and assigned to a specific job. This form does not allow you to pick items that are either lot or serial tracked; you must manually post these items using Job Material Transactions.

Fill in the necessary fields and click the **Print** button. After you create a job pick list, you can print the job packet.

See "Printing the Job Packet" on page 66.

### Entering Job Transactions

To record the details of the various activities involved in the setup, issuing of material to, running, and completion of a job order, as well as moving finished goods from the job to inventory, you must enter job transactions in the system.

**Note:** Use the **Perform Additional Validation** shop floor control parameter to help avoid entering incorrect job transactions. If you post an incorrect transaction, you can reverse it by entering a negative transaction.

See "Reversing a Job Transaction" on page 194.

There are two general types of job transactions: material transactions and operation transactions.

#### Job Material Transactions

Job material transactions record the quantity of materials issued from inventory to the job (or returned from the job to inventory). You can enter material transactions using any of these methods:

- Use the Job Material Transactions form to enter transactions manually.
- Select the **Post Material Issues** option on the Job Pick List report to automatically issue the materials when you print the pick list.
- Use the Backflushing function to allow the system to enter the material transactions automatically.

**Note:** If you are issuing material to a rework order, you must enter the job transaction manually using the Job Material Transactions form.

To view the cost and quantity details of material transactions posted to a given job, run the Material Transactions Report or view the Accum Values tab on the Job Materials form.

## Job Operation Transactions

Job operation transactions record the details of the job operations, including:

- Setup, Move, and Run times
- Pieces completed or scrapped
- Pieces moved to the next operation
- Machine overhead
- The marking of an operation being complete.

To enter a job operation transaction:

- Use the Unposted Job Transactions form to create the transaction.
- Use the Post Job Transactions activity to post the transaction to the shop floor distribution journal.

## Moving Completed Pieces to Inventory

To move finished pieces from the job to inventory automatically when you create the job transaction, select the **Job Stock Transaction** field on the Shop Floor Control Parameters form.

If you need greater permissions control over the recording of finished pieces, clear the **Job Stock Transaction** field. With this field cleared, you must first enter the job transaction and then use the Job Receipt form to receive the finished goods into inventory. The Job Receipt form requires Inventory Control authorization.

## About Posted Job Transaction Calculations

### Performing the Posting Process

The system sorts the unposted job transactions by job number, by operation within a job, and then by close-operation transactions within operations. Any transactions that close a job are processed last for that job.

If an error occurs, the system stops the job transaction posting and displays an error message. (The system does not post the transactions appearing after the transaction containing the error.)

When you return to the Unposted Job Transactions form, The system displays the transaction in which the error occurred. You can then correct the error and repost the transaction. The system resumes posting the remaining job transactions.

## Error Messages

If physical inventory is in process for the default warehouse, the system displays a warning when you initiate the posting. You may continue or cancel the posting. If you elect to continue and the transaction involves moving items from or to a warehouse location where physical inventory is in process, The system stops the posting and displays an error message. This function allows you to post WIP-only related transactions.

## Calculations for Various Transaction Types

- Setup transactions include the hours a resource worked in setting up a work center to perform an operation of a job.
- Run transactions apply charges to a job operation for labor hours and the quantity of goods completed, scrapped, and moved to the next operation. If the work center for the operation is labor scheduled rather than machine scheduled, the remaining scheduling time for the operation is reduced by the Total Hrs posted.
- Move transactions record the quantity of goods completed, scrapped, and moved at an operation without recording any labor or machine hours. Move transactions adjust these quantities on the Job Operations form.
- Indirect labor transactions charge employee labor to an indirect labor code rather than to a job.
- Machine transactions apply machine overhead charges to a job operation for the hours a machine was run, along with the quantity of goods completed, scrapped, and moved to the next operation.
- Queue transactions allow you to log the amount of time a job has been in a queue waiting for resource availability.
- Direct labor transactions charge the hours an employee has worked on a job operation. Direct labor transactions add labor cost, labor overhead, and adjust the run rate in the work center. Direct labor transactions do not reduce the run time remaining on an operation. The system adds labor cost and labor overhead to the Job WIP when you post job labor transactions.

## Setup Transactions

To compute labor cost, the system does the following, in this order:

- Multiplies the total hours by the pay rate.
- Adds the labor cost to the total setup cost.
- Adds the total hours to the total setup hours.
- If you specified labor overhead rates on the Departments form, the system calculates the **Variable Labor Overhead** amount and adds it to the **Total Variable Overhead**, and then calculates the **Fixed Labor Overhead** amount and adds it to the total fixed overhead.
- Computes a new Average Setup Rate and updates it on the Work Centers form, **Costing** tab.

## Run Transactions

To compute labor cost, the system does the following, in this order:

- Multiplies the total hours by the pay rate.
- Adds the labor cost to the total run cost. Adds the total hours to the total run hours.



- If you specified labor overhead rates on the Departments form, the system calculates the **Variable Labor Overhead** amount and adds it to the **Total Variable Overhead**, and then calculates the **Fixed Labor Overhead** amount and adds it to the total fixed overhead.
- Computes a new Average Setup Rate and updates it on the Work Centers form, **Costing** tab.

The system also performs the additional posting for the move transaction for all run transactions.

### **Direct Transactions**

Labor is added to a job, but the labor remaining on a job is not reduced.

### **Indirect Transactions**

No posting is performed. Only the Payroll Generation function refers to this job transaction.

### **Queue Transactions**

If the total hours is a positive number, the system increments the **Tot Qty Queued** field by one. If the total hours is a negative number, the system decrements the **Tot Qty Queued** field by one.

The system computes a new Avg Queue Hours and updates it on the Work Centers form, **Scheduling** tab.

### **Machine Transactions**

For all run transactions, the system also performs an additional posting described below for the move transaction.

### **Variable and Fixed Machine Overhead**

The system applies machine overhead to the job using the following formula:

$$MO = OMRH / ER * (FMOR + VMOR)$$

- MO = Mach Ovhd
- OMRH = Oper Mach Run Hrs
- ER = Efficiency Rate
- FMOR = Fix Mach Ovhd Rate
- VMOR = Var Mach Ovhd Rate

On the Unposted Job Transactions form, Oper Mach Run Hrs = the Total Hours field when the transaction type is Machine.

You can define the Fix Mach Ovhd Rate and Var Mach Ovhd Rate. These rates default when adding new operations for this work center to a bill of material, but can be changed on the Job Operations form.

## Move Transactions

The system adds the **Completed**, **Scrapped**, and **Moved** fields to the corresponding **Completed**, **Scrapped**, and **Moved** fields on the Job Operations form. The system adds the **Scrapped** field amount on this form to the **Scrapped** field on the Job Operations form.

If the **Next Operation** field contains an operation number, the system adds the **Moved** field to the **Received** field of the Job Operation form for that operation. The system then posts a WIP Move Material Transaction record.

If the **Move to Loc** field contains a stockroom location, the system adds the **Moved** field to the **Completed** field on the Job Operations form. Then, the system increases the quantity at the stockroom location by the moved quantity.

If you enter a new lot, the system creates a new Stockroom Location Lot record using the **Moved** qty as the **On-hand** qty.

## Variable and Fixed Labor Overhead

You specify **Variable** and **Fixed Labor Overhead** amounts on the Departments form or on the job operations form. The system calculates the variable and fixed labor overhead by using these formulas:

Variable Labor Overhead = Total Hrs \* Var Lbr Ovhd Rate

Fixed Labor Overhead = Total Hrs \* Fix Lbr Ovhd Rate

## Printing the Job Packet

The Job Packet form prints the paperwork that follows the actual job throughout the production process, including these:

Option	Description
Job Header	Provides a summary of the job, including: <ul style="list-style-type: none"><li>• Status of the job</li><li>• Item description</li><li>• Details about how the job was created</li><li>• Information about job material quantities</li><li>• Job schedule dates</li></ul>
Job Traveller	Provides, in sequential order, a listing with details of all the stages (work centers) involved in the job.
Operation Listing	Provides a detailed list, for each unit, of the materials and time required at each stage (work center) of the job.
Material Pick List	Provides a detailed list of all the materials required to complete the job. This report indicates: <ul style="list-style-type: none"><li>• The quantity of each material item required</li></ul>

Option	Description
	<ul style="list-style-type: none"> <li>• The quantity available</li> <li>• A place for someone to notate the quantity actually picked up.</li> </ul>
Job Tickets	Provides a form that employees can use to manually record labor and productivity information. This form can be used later to enter the information into the database, using the Unposted Job Transactions form.

**Note:** The **Material Pick List** option executed from this report does not post any materials to the journals. To post and allow the system to pick needed material, use the Job Pick List report.

- 1 Enter a starting and ending job number, item, operation, and job date, and accept the remaining defaults. See the help topics for individual fields for descriptions of options on this report.
- 2 Click the **Print** button to print the report. By selecting the defaults, you print the Job Header, Operation Listing, and the Material Pick List in an 80-column format.

You can select a variety of options in several combinations on this form. We recommend you experiment with this report and create a set of options that work for your environment. Then select **Actions > Store Options** to save selection criteria. To retrieve your saved options, select **Actions > Get Options**.

After you print the job packet, you can record labor and move finished goods to inventory using job transactions.

## Using Co-products and By-products

### About Co-Products and By-Products

You can create jobs that make groups of items, rather than a single item. The group is called a co-product mix.

Co-product items are grouped together by means of a co-product mix, a grouping of items that are produced together. Every co-product mix must contain one lead co-product. The lead co-product determines the default values for the co-product mix. The lead co-product also identifies the co-product mix on most reports and queries.

**Note:** You can identify an item as the lead co-product in a preferred co-product mix by selecting the **Preferred Co-Product Mix** field on the Items form for that item. When you create a co-product job and select this item as the lead co-product, the preferred co-product mix defaults to the job.

### General Guidelines

Follow these guidelines when using co-products and by-products:

- Co-products and by-products resulting from a job must be valid items on the Items form.
- Both Actual and Standard cost types are supported for co-products and by-products.
- Production schedules and estimates are not supported when using co-products, but they are supported for by-products.
- Lot tracking is supported for co-products and by-products.
- Serial tracking is not supported for by-products.
- Use the Job Receipts form to receive serial tracked items from a co-product job.
- By-products are identified on a job by a - (minus sign) in the bill of material. By-products are negative issued into inventory from a job, either manually or as backflush items.
- By-products cannot be cross-referenced.
- For MRP and APS, each co-product item in a co-product job displays as an outstanding receipt with the same job number. By-products display as negative requirements.

### Co-Product Mix Generation

There can be only one bill of material and routing for each co-product job -- a job that makes all the items defined in the co-product mix. Generation merges the co-product's bills of material and routings into one BOM and takes the default values from the lead co-product. The system compares the co-product mix operations against the lead co-product operations during the co-product mix validation.

Run the Validate Co-Product Mix Cost Distribution form to see errors or warnings that occur when the BOMs are consolidated. You can also run the Generate Co-Product Mix Cost Distribution form to generate the consolidated BOM for the co-product job. The generation also calculates the cost distributions for each co-product mix operation.

### Co-Product Jobs

You can create a co-product job manually, from a co-product mix, or a previous co-product job. You can make adjustments to a co-product job at the item-BOM level, the co-product mix level, and at the job level.

**Note:** If you have a data collection solution, CloudSuite Business allows data collection job transactions that include co-product mixes. By-products are not supported.

### Reports

The following reports contain specific co-product information:

- Current Job Cost Variance Report
- Job Cost Detail Status Report
- Job Cost Variance Report
- Job Exception Report
- Job Packet
- Job Pick List
- Job Transactions
- Scrap Analysis Report

## Co-Product Mix Distribution Formula

The system uses the formulas shown below when calculating co-product mix distributions for material, labor, and machine cost.

The co-product cost distribution is generated through these forms:

- Co-Product Mix Operations
- Job Orders
- Co-product Job Orders
- Generate Co-product Mix Cost Distribution

### Co-Product Material Distribution Percentage

Co-Product Material Cost % per operation = (Material Cost in Co-Product Item BOM \* Co-Product Quantity) / Total Material Cost in Combined Co-Product BOM

### Co-Product Labor Distribution Percentage

**Note:** Setup costs are not used when calculating the labor cost distribution. Setup costs, however, are distributed among the co-product items in the job based upon the labor cost distribution.

Co-Product Labor Cost % per operation = (Labor Cost in Co-Product Item BOM \* Co-Product Quantity) / Total Labor Cost in Combined Co-Product BOM

### Co-Product Machine Distribution Percentage

Co-Product Machine Cost % per operation = (Machine Cost in Co-Product Item BOM \* Co-Product Quantity) / Total Machine Cost in Combined Co-Product BOM

## About Co-Product Mix Validation

The system checks several attributes when validating a co-product mix or a co-product mix for a specific job.

### Error Validation

You receive error messages if any of the following are not valid, causing the validation processing to stop:

- Co-product items must have valid item records.
- Co-product items must be the same cost type.
- Co-product items cannot have a status of obsolete.
- Co-product items must be selected as manufactured.
- Co-product items cannot be configurable items.
- Lead co-product items must have operations.

- Common co-product operations (on the Current Operations form) associated with co-product items must have these identical settings:
  - Work centers
  - Resource groups
  - Resource group Action and Quantity values
  - Backflush
  - Machine Hours/Piece or Pieces/Machine Hour
  - Labor Hours/Piece or Pieces/Labor Hour
  - Fixed Schedule Hours
  - Setup Hours
  - Setup Rule
  - Setup Basis
  - Setup Matrix
  - Schedule Driver
  - Break Rule
  - Queue hours
  - Split Size
  - Offset
  - Custom planner rule
  - Scheduler rule
  - Setup resource group
- Co-product items must have the same backflush settings and location as the lead co-product.
- Co-product item numbers cannot be the same as material item numbers.

### Warning Validation

You receive warning messages if any of the following are not valid. Warning messages do not stop the validation process.

- Co-product items cannot have a status of slow-moving.
- Co-product items in a co-product mix must have the same product code as the lead co-product. The lead co-product determines the job's product code.
- Co-product items cannot be phantom items.
- Co-product job operations must match the lead co-product operations.
- All co-product items in a co-product mix must have the same setting for rev tracking.
- Co-product items (other than the lead co-product) should have operations, and these operations should match the operations of the lead co-product.
- Common co-product operations (on the Current Operations form) should have the same values in these fields: **Setup Rate**, **Labor Run Rate**, **Variable Overhead Rate**, **Fixed Overhead Rate**, **Fixed Overhead Rate Machine**, and **Variable Overhead Rate Machine**.
- Co-product items should have the same unit of measure. They should also have the same lot tracking setting.

- All cost distribution percentages must equal 100% in each co-product operation. (The system does not validate cost distribution percentages on the Generate Co-Product Mix Cost Distribution form or the Co-Product Mix Operations form).

### Forms Where Validation Occurs

The system validates co-product mixes on these forms:

- Co-product Job Orders
- Co-Product Mix Operations
- Generate Co-Product Mix Cost Distribution
- Job Orders
- Validate Co-Product Mix Cost Distribution

**Note:** On the Co-Product Job Orders form, the system validates the co-product mix for a specific job only.

## Changing the Cost Distribution for a Co-Product Mix

To change the cost distribution for a co-product mix:

- 1 Open the Co-Product Mix Operations form.
- 2 Select the co-product mix.
- 3 Select the co-product mix operation you want to modify.
- 4 Enter the cost distributions for the co-product items for that operation.
- 5 Repeat Steps 3-4 for each additional co-product mix operation.
- 6 Select **Actions > Save**.

## Creating a Co-Product Job Order

You can create a co-product job on the Job Orders form and maintain its co-products or by-products using either the **Co-products** tab on the Job Orders form or the Co-product Job Orders form.

To create a co-product job order:

- 1 Open the Job Orders form and on the toolbar, click the Filter-In-Place button.
- 2 Select **Actions > New**.
- 3 In the **Output Type** field, select **Co-product Mix**.
- 4 Specify standard job order information, with these differences:
  - Item: Enter a valid item number for the lead co-product item.
  - Revision: Enter the revision number of the item.



**Caution:** An error message displays if the co-product items have a different revision track setting and the validation fails.

- Released: Enter the number of items to be produced for this job. The value you enter must be an integer multiple of the total number of co-product items in the co-product mix.

See "Creating a Job Order Manually" on page 43.

- 5** On the **Co-products** tab, specify the **Co-product Mix**. If you are using a co-product mix that has already been defined on the Co-product Mix form, accept the default, or enter another co-product mix that contains the same lead co-product item. By default the system uses the lead co-product item's **Preferred Co-product Mix** on the Items form.
- 6** Select **Actions > Save**. Co-product information is automatically entered in the Co-products grid and on the Co-Product Job Orders form for this order.

You can now add a co-product routing and bill of material to the job.

**Note:**

- You can change co-product information on either the **Co-products** tab on this form or using the Co-Product Job Orders form.
- If you need to add, remove, or update co-products for this job, either change the co-product mix quantity or cross reference the job using the **References** tab on this form. On the **References** tab, do not cross-reference a co-product job to a customer order line item or project.
- If the Molding pack is enabled and you need to specify the number of cycles that will be performed on the resource for the co-product job, enter this in the **Product Cycles** field on the **Co-products** tab and then save again.

## Creating an Estimate Co-product Job

If you're using the Molding Industry Pack, a **Co-products** tab is provided on the Estimate Job Orders form for maintaining co-products on an estimate job order. Alternatively, you may quickly create estimates on the Estimate Job Order Quick Entry form.

To create an estimate co-product job order:

- 1** Open the Estimate Job Orders form and on the toolbar, click the Filter-In-Place button.
- 2** Select **Actions > New**.
- 3** In the **Output Type** field, select **Co-product Mix**.
- 4** Specify standard estimate job order information, with these differences:
  - Item: Enter a valid item number for the lead co-product item.
  - Revision: Enter the revision number of the item.



**Caution:** An error message displays if the co-product items have a different revision track setting and the validation fails.



- Released: Enter the number of items to be produced for this job. The value you enter must be an integer multiple of the total number of co-product items in the co-product mix.

**5** On the **Co-products** tab, specify the **Co-product Mix**. If you are using a co-product mix that has already been defined on the Co-product Mix form, accept the default, or enter another co-product mix that contains the same lead co-product item. By default the system uses the lead co-product item's **Preferred Co-product Mix** on the Items form.

**6** Select **Actions > Save**. Co-product information is automatically entered in the Co-products grid.

**Note:**

- If you need to add, remove, or update co-products for this estimate job, either change the co-product mix quantity or cross reference the job using the **References** tab on this form. On the **References** tab, do not cross-reference an estimate co-product job to a customer order line item or project.
- If you need to specify the number of cycles that will be performed on the resource for the estimate co-product job, enter this in the **Product Cycles** field on the **Co-products** tab and then save again.

## Creating or Changing a Co-Product Mix

To create a co-product mix you will use for several co-product jobs:

- 1** Open the Co-Product Mixes form.
- 2** Select **Actions > New**.
- 3** Select a lead co-product.
- 4** Select **Actions > Save**. The system defaults to the next unique preferred co-product mix identification value.
- 5** Enter a co-product mix description.
- 6** Select **Actions > Save**.
- 7** Add co-products to the co-product mix by clicking in the grid and selecting an item from the drop-down list.
- 8** When you are finished adding co-products to the mix, select **Actions > Save**.

## Generating the Job Routing for Co-Product Jobs

You can add a routing to a co-product job by generating the routing from co-product mix information, or by copying the information from an existing co-product job instead of entering the information manually.

You can generate a routing from these forms:

- Job Orders
- Co-product Job Orders
- Copy Routing BOM

- 1** Use the Job Orders form to generate the routing from the co-product mix information:

- a Select the co-product job to work with. Its status must be Firm.
- b Select the **Co-products** tab.
- c Click **Generate Cost Distribution and Routing**. The system generates the routing from the co-product mix information to the selected job.
- d To save the changes, select **Actions > Save**.

You can schedule the job by running the Scheduling activity.

Or, you can update the planned material costs by opening the Items form, selecting the **Item Costs** button to open the Item Costs form, selecting **Actions > New**, and then selecting the **Cost Maint** tab.

- 2 Use the Co-product Job Orders form to generate the cost distribution for a specific co-product job:
  - a Select the co-product job to work with.
  - b Click **Generate Cost Distribution and Routing**. The system generates the routing from the co-product mix information to the selected job.
  - c To save the changes, select **Actions > Save**.
- 3 Use the Copy Routing BOM form to add the routing to a job by copying the information from another co-product job.
  - a Select the category that identifies the source of what you are copying from.

**Note:** Copying from a job and from an actual job both copy the routing/BOM from another co-product job.
  - b The category you select determines which other fields are active in the From group box. As applicable, select the job, schedule ID, item, revision, and starting and ending operations that you want to copy from.
  - c Select the category that identifies the source of what you are copying to.
  - d The category you select determines which other fields are active in the To group box. As applicable, select the job, schedule ID, item, and revision that you want to copy to. Also if applicable, select the operation after which you want to copy the selected range of operations.
  - e Select the date the operation will be included in the current bill of material, or accept the default of today's date.
  - f Under **Copy Indented BOM**, select **Yes** if you want to copy the complete indented bill of material, or accept the default of **No** to copy only a single-level.
  - g Under **Extend By Scrap Factor**, select **Yes** if you want to use the scrap factor from the Current Materials form as the variable to determine the required quantity of a current material.
  - h In the **Option** field, select one of these options to indicate how the selected information will be used:
    - **Delete All:** Delete the information specified.
    - **Insert Range:** Insert the information and resequence the operation numbers.
    - **Replace Range:** Replace existing information.
  - i Select one of the following:
    - **Labor:** Copy only the labor portion of the routing.
    - **Material:** Copy only the material portion of the bill of material.

- Both: Copy both the labor and material.
- j Click **Process**.
- 4 If you are working with a job, you can now release the co-product job.

## Selecting a Preferred Co-Product Mix for an Item

To select a preferred co-product mix for an item:

- 1 Open the Items form and select the item for which to select the co-product mix.
- 2 Select the **Controls** tab.
- 3 In the **Preferred Co-product Mix** field, enter a default co-product mix for this item. This default is the preferred co-product mix that is used by the system when this item is a lead co-product in a co-product mix.
- 4 Select **Actions > Save**.

## About Job Costs

### About Job WIP Costs

The system maintains two sets of work-in-process (WIP) cost buckets for each job: **WIP Total** and **WIP Complete**. Both buckets are divided into subcategories for material, labor, fixed overhead, variable overhead, and outside costs.

In general, **WIP Total** is the cost that has gone into WIP for the job. **WIP Complete** is the amount moved out of WIP when the completed item was moved into inventory. The two values mirror the debits and credits to the job's WIP accounts, which are sent to the Shop Floor Distribution journal. The **WIP Remaining** value is the balance of the WIP Accounts for the job.

The **WIP Total** and **WIP Complete** fields are printed on the WIP Valuation report, along with the WIP Remaining column, which displays the difference of the total and complete values. You can also view the **WIP Total** values on the **Cost Detail** tab on the Job Orders form.

**Note:** When you issue a manufactured material to the job, the system does not put the material's total value into the WIP Material Total bucket. The cost breakdown (material, labor, etc.) at which the material was being carried in inventory is carried over to the corresponding WIP Total buckets. Therefore, the WIP Labor Total bucket contains the labor portion of any issued material's cost as well as all labor cost posted directly against the job.

## How the WIP Values are Calculated When Using Actual Costing

If you are using Actual costing (whether Average, LIFO, FIFO, or Specific), the WIP Total is the actual cost posted to the job. WIP Complete represents the total cost at which pieces have been moved from the job into inventory.

Depending on how the job is processed and how the **Costs Based on Complete** shop floor control parameter is set, the transactions that move the item into inventory may be performed at the job's planned cost, actual cost, or a combination of the two (see the **Costs Based on Complete** field topic for a description of the job's planned and actual cost). Therefore, if the planned cost is considerably higher than the actual cost posted to date, **WIP Complete** will exceed **WIP Total**, causing a negative **WIP Remaining** value on the WIP Valuation report.

When you close the job, the system sets **WIP Complete** equal to **WIP Total**.

- If you close the job using a job transaction that moves the item into inventory, the move transaction is performed at the difference between the **WIP Complete** and **WIP Total**; therefore, no costs need to be written off.
- If you close the job manually by changing the job's **Status** field to complete on the Job Orders form, the difference (the amount still in WIP) is written off to the Inventory Adjustment account.

## How the WIP Values are Calculated When Using Standard Costing

If you are using Standard costing, the system increments the WIP Total by what it calculates as the standard cost of each individual transaction posted against the job.

For example, if you post a run transaction that completes pieces at an operation, the system debits WIP and posts to WIP Total the amount of labor (and perhaps overhead) necessary to complete that quantity. It does so using the planned labor hours, run rate, efficiency, etc. found in the either the job's routing or the item's standard routing (depending on how the **Calculate Variances Against** shop floor control parameter is set).

With Standard costing, all transactions that move the item into inventory are done at the item's standard cost. So, when you move an item into inventory, the system posts the WIP Complete buckets with (quantity moved \* the item's standard unit cost). **WIP Remaining** can also be negative if the standard costs of the individual transaction's costs posted into WIP are less than the item's standard cost.

When the job is closed, the system sets the **WIP Total** equal to **WIP Complete** (the opposite of what occurs with Actual costing). It writes any difference between the two to either Material Usage Variance, Routing Variance, or both accounts. You can think of this difference as the difference between the "standard" value of each transaction posted against the job (WIP Total) versus the standard cost of the item \* the quantity completed on the job (WIP Complete). After the system calculates the material usage variance and routing variance, it sets the **WIP Total** values equal to the **WIP Complete** values so it does not write off the same routing variance amount again in the event you re-open or re-close the job.

## About Material Usage Variances

The material usage variance is a general ledger account the system uses for job material issues or withdrawals where the quantity issued/withdrawn is not equal to the standard quantity required.

---

When you close a job for a standard-costed item, the system uses this formula to calculate the material usage variance for each material:

$(\text{qty issued} - \text{qty variance} - \text{qty required}) * \text{item standard cost}$

Where:

- qty issued: The quantity issued of the material to the job.
- qty required: The quantity of the materials that should have been used on the job. Calculated as:
  - if material is per unit:  $\text{job qty complete} * \text{material qty per assembly}$
  - if material is per lot: material quantity per assembly
- qty variance: The quantity variance written off to material usage variance on previous closings of the job.
- item standard unit cost: The material's standard cost at the time the job is closed.

## About Routing Variances

The routing variance is a general ledger account used for clearing money still in WIP when a job for a standard-costed item is closed. The system makes entries to this account when there is a difference between the amounts that went into and out of WIP not attributed to a material usage variance, labor rate variance, labor usage variance, or overhead usage variance.

The majority of entries to routing variance occur when jobs are closed, and in some situations, entries occur when you post job transactions. Sometimes the system uses the routing variance account as a default account for variances that occur for which there are not specific variance accounts. To limit entries to this account and to ensure entries are made to the more specific accounts such as labor rate variance, labor usage variance, overhead usage variance, etc., set the **Calculate Variances Against** parameter to **Standard**.

Routing variances may occur for the following reasons (some of these examples depend on the setting of the **Calculate Variances Against** parameter):

- Under- or over-reporting production at operations
- Scrapping items as they are being moved through the routing
- Moving more or fewer items to inventory than were moved through the routing
- Not posting a setup transaction against an operation that has planned setup hours
- Entering a quantity complete on a job that is different than the item's lot size for an item that has setup cost and/or per-lot materials
- Calculate Variances Against = Actual: a job operation's rates and times are different from the values for that operation in the item's standard routing
- Calculate Variances Against = Actual: the quantity per assembly of a material on the job is different than its quantity per in the parent item's standard BOM
- Calculate Variances Against = Actual: a job operation exists that is not in the item's standard routing
- Calculate Variances Against = Standard: the overhead rates on the job operation are different than those on the item's standard operation

**Note:** Multiple reasons may apply to any one job. Therefore, if you are attempting to identify a routing variance amount for a job, you should determine how many reasons apply and total your estimated calculations for each reason (or net them, since some reasons may cause a debit while other reasons

cause a credit on the same job). See our support site for knowledge base article 687030, which provides detailed recommendations for identifying and avoiding these variances.

## Recovering WIP Costs for a Job Closed Accidentally

If you accidentally close an in-process job, all costs that were in WIP will be written off to the item's inventory adjustment account (if the item is Actual-costed) or to variance accounts (if Standard-costed). Also, the WIP buckets on the job will be cleared.

The system writes these WIP-clearing entries to the SF Dist journal. You can change the job's status back to Released to continue processing, but doing so does not move the written-off cost back into WIP.

Therefore, the only way to recover the WIP costs is to issue a non-item master material to the job for the total cost that had been written off. When you do this, you can enter the cost at which to issue the item and the offsetting account to WIP. The detailed steps are as follows (read all the steps before attempting this process):

**1** To find the amounts that were written off, locate the journal transactions in the SF Dist journal that were created when you closed the job. The transactions have a different reference depending on how the job was closed:

- If the job was closed on the Job Orders form, look for INV JCLS + job number.
- If the job was closed via a job transaction, look for INV JFIN + job number.

There may be up to five entries to the job's WIP accounts (material, labor, fixed ovhd, variable ovhd and outside). If the parent item on the job has a cost type of Actual, the offsetting account is Inventory Adjustment. If the cost type is Standard, the offsetting accounts are Material Usage Variance and/or Routing Variance.

**2** Issue a non-item master item to the job. Follow these steps:

- a Open the Job Material Transactions form and add a new transaction for the job (click in an empty row in the grid to add a new transaction).
- b Select the check box in the **Select** field for your new transaction.
- c In the **Item** field, enter an item ID that represents the process, such as "RECVRD\_WIP\_COST."
- d In the **Quantity** field, specify **1**.
- e In the five cost buckets, enter the amount that had been written off to each WIP account into the appropriate bucket.
- f In the **Other Account** field, enter the account to which the amounts had been written off. If the item is Actual costed, enter the inventory adjustment account that was hit when the job was closed. That will then reverse the entry that was made to Inventory Adjustment when the job was closed.

If the item is Standard costed, both Material Usage and Routing Variance may have been hit. If only one of the two were hit, enter that account into the **Other Account** field. If both were hit, enter one of the two accounts and then enter a general journal transaction, which reverses the appropriate amount into the other account.

**3** Click the **Process** button to post the transaction. This message is displayed:

"Not one job material where item is RECVRD\_WIP\_COST exists for job operation that has [job number] and [operation number]. Add will be performed for job material."

**4** Click **OK**.

At this point, all of the costs will be back in the WIP accounts in the general ledger and the job's WIP buckets. Also, the amounts will have been reversed from the accounts into which they had originally been cleared.

## About Planned Costs on a Job

On the job costing reports (listed in the See Also link above), the planned cost consists of these cost figures:

### Material Cost

If material is Per Unit:  $(\text{job qty Released} * \text{material qty per assembly} / (1 - \text{scrap factor})) * \text{material unit cost}$

If material is Per Lot:  $(\text{material qty per assembly} / (1 - \text{Scrap Factor})) * \text{material unit cost}$

### Material Overhead Cost

Material overhead is calculated the same regardless of the material's type.

Fixed Material Overhead:  $\text{Material Cost} * \text{material Fixed Overhead rate}$

Variable Material Overhead:  $\text{Material Cost} * \text{material Variable Overhead rate}$

### Setup Cost and Overhead

For each operation, the system calculates the planned setup hours and then the planned setup cost and labor overhead associated with setup.

Setup Time:  $(\text{Setup Hours} / \text{Efficiency})$

Setup Cost:  $\text{Setup Time} * \text{Setup Rate}$

Fixed Setup Overhead:  $\text{Setup Time} * \text{operation Fixed Labor overhead rate}$

Variable Setup Overhead:  $\text{Setup Time} * \text{operation Variable Labor overhead rate}$

### Run (Labor) Cost and Overhead

For each operation, the system calculates the planned run time and then the planned run cost and run labor overhead.

Labor Time:  $\text{job quantity Released} * (\text{operation Labor Hours Per Piece} * \text{Quantity Resources})$

Run Cost:  $\text{Labor Time} * \text{operation Run Rate}$

Fixed Overhead: Labor Time \* operation Fixed Labor overhead rate

Variable Overhead: Labor Time \* operation Variable Labor overhead rate

### Machine Overhead

For each operation, the system calculates the planned machine time and then the planned machine overhead costs:

Machine Time: job quantity Released \* (operation Machine Hours Per Piece / Efficiency)

Machine Fixed Overhead: Machine Time \* operation Fixed Labor overhead rate

Machine Variable Overhead: Machine Time \* operation Variable Labor overhead rate

## How Scrap Affects Job Cost

You can scrap pieces of the parent item on a job by entering the scrapped quantity in the **Scrapped** field when entering a job transaction. How the scrapping of pieces impacts the costing on the job depends on whether the item is actual or standard costed.

### Actual Costing

For actual-costed items, scrapping pieces affects the cost at which the good pieces are moved into inventory.

- If you close the job when you move the pieces into inventory, the job's actual total cost is spread over the move quantity; therefore, those pieces absorb the cost of the material and labor that went into the scrapped pieces. For example, suppose that with a job for a quantity of 10, you post \$1000 against the job and completed and moved 8 into inventory, while scrapping 2. Those 8 would be moved to inventory at \$125 per unit (1000 / 8).
- If you do not close the job as part of the move, the completed pieces are moved using the job's planned unit cost. If you then close the job manually, the cost left in WIP is written off to inventory adjustment and will include the cost that went into the scrapped pieces.

### Standard Costing

For standard-costed items, scrapping pieces does not affect the move-to-stock cost (which is always done at the item's standard cost), but it does result in variances. Any actual labor you posted for work on the scrapped pieces goes into labor usage variance. All material issued for the scrapped pieces goes to material usage variance.

### Example

Suppose you have an item with one standard operation that has 1 hour per piece with a run rate of \$15. There is one material in its BOM with a standard cost of \$10, giving the item a standard cost of \$25. You then release a job for 10 and issue 10 of the material. WIP is debited and the material's inventory account is credited \$100.



You post a run transaction for 10 hours that completes 8 and scraps 2, and the employee's rate is \$15. WIP labor is debited with the labor to make the 8 pieces (\$120), direct labor applied is credited with the actual labor (\$150) and labor usage variance is debited with the difference (\$30).

The 8 good pieces are moved into inventory and taken out of WIP at its standard cost of \$25 (total \$200). The remaining \$20 in WIP is the value of the material that went into the 2 scrapped pieces of the parent. When you close the job, that scrap is written off to material usage variance.



## Production Schedules Overview

Production schedules allow you to authorize and release production in a simplified manner. A production schedule functions as a blanket job order. Production schedules are sometimes also referred to as work-orderless production.

You create production schedules for an entire plant, planner, family of items, or specific customer for a selected time period. You can set up a production schedule for an item with releases for each month of the year; you don't have to create a separate job order each month or each time the item is manufactured.

A typical usage is the creation of a monthly production schedule with daily releases. You add subsequent releases to an existing production schedule or create an entirely new production schedule.

**Note:** Production schedules do not support co-product jobs.

Production schedules are characterized by:

- Items manufactured using production schedules must be set up for Standard costing on the Items form. The Items setting dictates that, if you also manufacture this item through a job, the job also uses Standard costing.
- Items are identified with a production type that represents the most frequently used manufacturing method: job, production schedule, or JIT production. You use this information for MRP, APS, and MPS firming.
- A routing and bill of material is associated with each item on a production schedule.
- You can easily modify production schedules in response to production performance.
- To facilitate the development and maintenance of production schedules, the system includes utilities that:
  - Use Generate Production Schedules (Rate Based) to create production schedules for a date range
  - Use Delete Production Schedule Releases to delete a range of production schedule releases
  - Use Copy Production Schedules to copy a selected production schedule and its releases.
- The Scheduler recognizes the load that production schedules with Released status create. You can specify whether to include released production schedules in the schedule by selecting the **Schedule Released Production Schedules** parameter on the Shop Floor Control Parameters form. The Scheduler does not schedule production schedules with a status of Planned.

- MRP Planning and APS Planning explodes production schedules for their component items. Receipts defined by a released production schedule appear on the Planning Detail and Planning Summary Displays and are pegged to the appropriate production schedule. MRP and APS view a production schedule as a regular demand for items with a due date. Thus, a daily production schedule for 10 items per day is planned as five daily orders for 10 items.

**Note:** MRP and APS consider planned production schedules only if you select the **Plan Planned Production Schedules** planning parameter before you run the Planning activity.

- You can create production schedules during the firming process of MRP or APS for either planned orders or MPS orders.
- Production schedules backflush those items that you specify.
- A report tracks the cumulative production for an item in time buckets you choose (daily, weekly, or monthly).

## Production Schedule Steps

Use production schedules to record repetitive or flow-based manufacturing processes.

**Note:** The system displays error or warning messages if you add an item flagged obsolete or slow-moving to a forecast, a planned order, or a master production schedule.

Follow these steps to track manufacturing through production schedules:

- 1 "Creating a Production Schedule Header" on page 84
- 2 "Entering Production Schedule Items" on page 85
- 3 "Entering Production Schedule Releases" on page 86
- 4 Entering production schedule routings and BOM. See "Creating Routings and Bills of Material" on page 11.
- 5 "Creating Production Schedule Transactions" on page 88.

## Creating the Production Schedule

### Creating a Production Schedule Header

Use production schedules to track continuous production occurrences that use similar manufacturing processes.

- 1 Open the Production Schedules form.
- 2 Select **Actions > New** to create a new production schedule.

**3** Specify the appropriate data in the required fields:

- **Schedule ID:** Specify a unique identifier composed of numbers, characters, or a combination. You can enter a global **Schedule ID Prefix** on the Shop Floor Control Parameters form. The system starts all generated production schedule IDs with this prefix, followed by a sequential number (maximum of ten characters for the combination).
- **Status:** Specify the status or accept the default Planned.

Optional fields include:

- **Description:** Describe the purpose or the process of the production schedule in this character field. The system does not validate this field.
- **Look Ahead and Look Behind:** Use these numeric fields to express the number of days in the past and the number of days in the future from the current day that production can be recorded. These fields are helpful when you do not record production on a daily basis.

**4** Save the production schedule header.

Now you can "add items" on page 85 to the new production schedule.

## Copying from Another Production Schedule

To copy a production schedule and its releases and create a new Planned production schedule, follow these steps:

- 1** Open the Copy Production Schedules form.
- 2** Enter the appropriate data in the required fields.
  - In the **From and To Schedule ID** field, enter the range of production schedule IDs from which to copy routing information.
  - In the **Starting and Ending Item** fields, enter the range of items to copy; leave the fields blank to copy all items.
  - In the **Starting and Ending Date** fields, enter the range of dates to create release lines for.
- 3** When finished, click **Process**.

## Adding Items and Releases

### Entering Production Schedule Items

Production schedule items are the finished-goods inventory items that the production schedule produces.

- 1** Open the Production Schedule Items form.

2 From the list, select the production schedule to which to add items.

3 Select **Actions > New** to add an item to this production schedule.

**Note:** An inventory item's cost type must be standard. A production schedule may contain multiple items. You cannot add items to a production schedule that has a status of Complete.

4 Enter the appropriate data in the required fields:

- Item: Enter or select a valid item number of a standard-costed inventory item.
- For Whse: Enter the warehouse code for the finished goods inventory. The default value is the **Default Warehouse** field (listed on the Inventory Parameters form).

Optional fields include:

- Revision: If the finished good item is affected by an Engineering Change Notice, enter the appropriate revision information. Use this information to report and track inventory that has specific production requirements.

**Note:** When you copy the current routing/BOM to a PS release, the current routing/BOM for this revision will be used.

5 Save the new production schedule item.

Now you can add additional items to the production schedule or create production schedule releases against the new item.

## Entering Production Schedule Releases

A production schedule release is the quantity of a finished-goods item you plan to produce on a specific day. You must create a release schedule for each finished-goods item on the production schedule.

You can add a release manually or generate multiple releases at one time:

- "Adding a Production Schedule Release Manually" on page 87
- "Mass-generating PS Releases" on page 87

**Note:** Before you can release an item, you must use the Roll Current Cost to Standard Cost form to roll the item's current operations and materials to standard.

### About Quantity WIP

When the status of a Production Schedule Release is changed to Released, the **Quantity WIP** for the parent item is updated to reflect the additional quantity on the Production Schedule Release. The system keeps this quantity up to date with changes on the Production Schedule Release (for example, transactions that complete pieces, Changes to the quantity released, etc.). This update occurs during any of the following:

- Add or update a production schedule release with a status of Released (all PS materials' **Alloc to Prod** values and **Quantity WIP** values are updated).
- Add, update, or delete a PS material (takes into account all releases with a status of Released).

- Delete a PS operation (all PS materials' **Alloc to Prod** and **Quantity WIP** values are updated).
- Generate production schedules with a status of Released on the Generate Production Schedules utility (all PS materials' **Alloc to Prod** and **Quantity WIP** values are updated).
- Change a production schedule status from Planned to Released (all PS materials' **Alloc to Prod** and **Quantity WIP** values are updated).

## Adding a Production Schedule Release Manually

Use the Production Schedule Items form to create production schedule releases manually.

- 1 Open the Production Schedule Items form (or click the **Items/Releases** button from the Production Schedules form).
- 2 Select a production schedule.
- 3 Select the PS item to which to add the release.
- 4 In the Production Schedule Releases grid area of the form, add a new line and enter the appropriate data in the required fields:
  - Due Date: Specify the date for which this production is being planned.
  - Status: Enter the status or accept the default of Planned.
  - Released: Enter the quantity to be produced for this particular production occurrence.

**Note:** When you update the status from Planned to Released, the system prompts you to copy a routing (if one does not exist). For a production schedule to have a Released status, it must have a routing.
- 5 To update the **Completed** and **Scrapped** fields, you must create a production schedule transaction.
- 6 Save the release.

Now you can create a routing and bill of material for the production schedule release See "Creating Routings and Bills of Material" on page 11..

## Mass-generating Production Schedule Releases

Use the Generate Production Schedules (Rate Based) form to mass-generate production schedule releases.

- 1 Enter the appropriate data in the required fields:
  - Item: Specify a valid inventory item number.
  - Quantity: Specify the total number to be completed or planned for.
  - Rate/Day: Specify the number to be completed per day. This process only schedules (plans) until the combined total for each Rate/Day equals the quantity.
  - Start Date: Specify the start date when Type = Forward or accept the default of the current system date. This is the date scheduling starts.
  - End Date: Enter the end date when Type = Backward. This is the date production is scheduled to end.

- **Frequency:** Enter the number of days that indicate how often you will generate a schedule or release for this production schedule.
- **Schedule ID:** Enter a production schedule number.
- **Type:** Select whether to schedule the releases Backward or Forward from the date you specify.
- **Status:** Select Planned or Released.
- **Copy to PS Item BOM:** Accept the default of selected to copy the item current routing/bill of material to the production schedule item (if the PS item does not contain a routing/BOM).
- **Copy to PS Release BOM:** Accept the default of selected to copy the production schedule item's routing/BOM to each of the new releases the activity creates. If the PS item does not contain a routing/BOM, the item current routing/BOM will be copied to the releases. This field is active only if the **Status** of the PS item is **Planned**. If the PS item status is set to **Released**, this field is selected automatically and you cannot change it.

2 Click the **Process** button to start the process.

# Processing the Production Schedule on the Shop Floor

## Creating Production Schedule Transactions

Use the Production Schedule Complete Transactions form to record the finished goods, and the Production Schedule Scrap Transactions form to record scrapped inventory.

### Record the Finished Goods

Use the Production Schedule Complete Transactions form to record transactions for finished goods.

**Note:** Production Schedule Complete transactions apply only to operations designated as control points.

Enter the appropriate data in the required fields. In the **Completed** field, enter the total number of items completed, excluding scrap. In the **WC** field, enter a work center from an operation that is a control point.

When finished, click **Process**.

### Record the Production Schedule Scrapped Inventory

Use the Production Schedule Scrap Transactions form to record scrapped inventory from production schedules.

**Note:** You can execute production schedule scrap transactions from any operation.

Enter the appropriate data in the required fields. In the **Scrapped** field, enter the number of the item that is being scrapped. In the **WC** field, enter any work center from any operation.



When finished, click **Process**.

## About Production Schedule Posted Transactions

The purpose of posting production schedule complete or scrap transactions is to have the system, where possible, automatically update the appropriate production schedule to indicate that the quantities have been completed or scrapped.

### Effects on Capacity

The load or capacity for the associated work center will also be reduced by a corresponding amount for the completed or scrapped quantity.

### Backflushing

#### Posting Process

The actual posting that takes place is conditional. The system makes the subsequent checks and performs these steps, in this order:

- The system must first identify the item's production schedule release date against which it will post the completed or scrapped quantities.
- The system determines potential production schedule releases based on the Look Ahead and Look Behind settings. You define these settings on the production schedule itself or on the Shop Floor Control Parameters form. On the Production Schedules form, if you leave the **Look Ahead** and **Look Behind** fields blank, The system uses the values in the corresponding fields on the Shop Floor Control Parameters form during transaction posting. On the Shop Floor Control Parameters form, if you leave the fields blank, the system considers the values to be zero. These settings establish a window within which the system posts completed or scrapped quantities against production schedule releases.

You post completed production schedule transactions to force the system to perform a cascading update of completed or scrapped quantities against released quantities. When the system determines a production schedule release date window to post against, it looks at all production schedule releases that have dates within the window. The system begins posting completed quantities starting with the first production schedule release where the date meets the criteria of the PS Look Ahead/Behind window. In addition to meeting the time frame of the window and in order to have quantities posted against that PS release date, the production schedule release must have a Released status.

A production schedule release can only be consumed or have the completed/scrapped quantities applied against it, up to the released quantity, unless that production schedule release is the last production schedule release that falls within the current PS Look Ahead/Behind window. In that case, the remaining quantities will be posted against the last production schedule release, and the completed/scrapped quantity will exceed the released quantity.

The Received and Moved fields are also updated for the appropriate operation. The completed, received, and moved quantities will be updated for all operations tied to the control point as part of the overall posting process.

## Correcting Posted Quantities

To make corrections to posted completed or scrapped quantities, you enter negative completed quantities (adjustments for over-entering into the system). The negative completed quantity cannot exceed the total of all the released quantities within the specified window. For example, if you had previously entered and posted a completed quantity of 50, it is not possible to enter a completed quantity of -51.

## Updating the Production Schedule Status

You can update the status of the production schedule itself, which in turn updates the status of all the production schedule's items, or you can update the status of the production schedule items and/or releases individually.

- 1 To update the production schedule header and items status:
  - a On the Production Schedules form, make sure that you are working with the schedule whose status you want to update.
  - b In the **Status** field, change the status from **Planned** to **Released**.
  - c Select **Actions > Save**.
  - d If no routings exist for the PS items, select **Items/Releases** to open the Production Schedule Items form so that you can copy the current routing and BOM information from the inventory item's routing and BOM.

**Note:** When you change the status of a production schedule, the status is updated on all the production schedule's PS items.

- 2 To update a production schedule release status:
  - a On the Production Schedule Items form, make sure you are working with the production schedule item that contains the release you want to update.
  - b In the grid at the bottom of the form, select the appropriate release.
  - c In the **Status** field, change the status from Planned to Released.
  - d Click **OK** at the confirmation message.
  - e Click **OK** again to copy the PS item routing/BOM (if one exists) or the item current routing/BOM to the PS release.
  - f In the **Due Date** field, select a due date for completion of this release.
  - g In the **Released** field, enter the release quantity.
  - h Select **Actions > Save**.

## Creating JIT Transactions

"Just-In-Time" (JIT) production is typically used for the production of items that have a standard cost and that you want to be able to produce on demand. It is based on the idea of producing items that are not tied to specific job orders or production schedules, and transactions are only recorded when the item is actually finished. Use the Just-In-Time Production Transactions form to enter such items into inventory.

To enter JIT production items into inventory:

1 Open the Just-In-Time Production Transactions form.

2 Fill in the appropriate fields:

- In the **Completed** field, type the total number of items completed, excluding scrap.  
This value cannot be zero. To enter items into inventory, use positive values. To remove items from inventory, use negative values.
- From the **Warehouse** drop-down list, select the warehouse where the finished goods are to be stored.  
If you try to select a warehouse with which the item does not already have an association, the system prompts you to create the association before you can select the warehouse. To create an item/warehouse association, use the Item/Warehouse form.
- In the **Location** field, enter the location where you want the items stored.  
If you try to enter a location for which the warehouse does not have an association with the item, the system prompts you to let you know that it will automatically create the association. Click **OK**.
- If the item is a lot-tracked item, in the **Lot** field, enter the lot identifier to be associated with this production transaction.  
If you try to enter a lot identifier that does not currently exist, the system prompts you, to let you know that it will automatically create the lot. Click **OK**.
- (Optional) Use the **Shift** and **Employee** fields to enter the shift in which the transaction is being performed and the employee performing it.
- If the item is a serial-tracked item, use the **Serial Numbers** tab fields to generate the serial numbers.

**3** When finished, click **Process**.

## Scheduling Overview

The Scheduler calculates the dates and times to work on a subset of existing orders—those manufacturing orders that you need to complete in the near future. You can run the schedule over any horizon: a shift, day, week, month, etc. However, you will usually run it for a one-day horizon, and you will usually run it each day. The Scheduler adjusts operation start and end times, suggests operation sequences, and reports changes in inventory levels. It also generates summary information (such as job performance) you can view in reports and graphs.

The Scheduler processes individual operations for any Released jobs within the defined time horizon based on their routing and setup, run, and move times. Depending on the settings on the Shop Floor Control Parameters form, the Scheduler can also schedule:

- Planned orders generated by MRP or APS
- Firm jobs
- Working estimate jobs
- Planned estimate jobs
- Production schedules

### Data Flow

A job authorizes manufacturing of a quantity of an item for one level of a bill of material. The Scheduler constrains the schedule on end items only. It assumes that any component materials have already been allocated to the job and does not treat them as requirements. The item specifies a routing, which identifies the sequence of job operations that must be completed to manufacture the item.

Each operation specifies one or more resource groups. A resource group is a list of similar resources. A resource is an entity, such as crewperson, machine, or fixture, that can perform the operation. An operation is required to specify at least one resource group. During scheduling, the system selects one or more resources from the group, depending on each resource's availability and on rules you define, to perform the operation.

Work Centers capture all costing information from the scheduling activities and do not directly affect the schedule.

## Forward Scheduling vs. Backward Scheduling

To achieve the best utilization of your resources, the Scheduler schedules jobs forward in time, starting at the current date/time and scheduling out until finishing the last operation of the last job. You cannot use the Scheduler to backward schedule. That is, the Scheduler cannot be configured to start from the last operation and work backward in time until reaching the first operation.

If you must backward schedule, you can use APS to schedule, populating the scheduling output forms and reports with the data generated from the planning run.

## Event-based Scheduling

The Scheduler works by running a simulation of all "events" that happen during the process of a demand moving through its production steps. For example, the resource starting an operation is an event, followed by another event for completing the operation.

## What Happens During Scheduling

For each demand being scheduled, the Scheduler places the quantity into a unit called a load. The load follows the item's routing. When a load arrives at an operation, it goes through these processing steps, depending on the resources, rules, and operation time you defined:

- 1 Process move time: The load moves from its previous operation (if any) to this operation.
- 2 Allocate resources to process the load: You define allocation rules to control how the Scheduler assigns resources. If the allocation rule can be satisfied, operation processing continues. If not, the Scheduler stops operation processing and the operation waits for the necessary resource to become available. It then attempts allocation each time a required/requested resource becomes available.
- 3 Process setup and run time: The Scheduler applies any setup and run hours to the load. If the operation uses **Fixed Schedule Hours**, the Scheduler uses the fixed value and ignores setup and run hours.
- 4 Free resources allocated to the load at this operation.
- 5 Process finish time: The Scheduler applies any post-operation finish hours to the load.
- 6 After operation processing is complete, the load moves to the next operation in the routing. The process continues until the last operation in the last job is reached.

## Simultaneous Requests for the Same Resource

Loads of items compete for the use of resources. Each resource has its own request queue to hold outstanding requests from loads. During operation processing, if the Scheduler cannot allocate a member of a required resource group to a load, it enters a request in a queue for each resource group member. A Sequencing Rule, which you specify on the resource record, determines the sequence in which requests are sorted in the queue.

When a resource in that group is free, the Scheduler allocates it to the waiting load and removes that load's requests from the other member resources. If there are multiple requests in the resource's queue, the Scheduler uses the resource's **Selection Rule** to determine which request to allocate first. If the load requires multiple resources from the group, the Scheduler does not allocate any resources to the load until the required number of resources from that group is available.

## Job Dates

The Scheduler uses a job's start date as an input value to its calculations. The Scheduler may update the job's start and end dates, but will only populate a blank start or end date if you are using the MRP planning mode. When you create jobs for subassemblies through copying a routing/BOM, the dates on those sub-jobs may be blank. If you are using APS, you must run APS Planning to populate the blank job dates. If you are using MRP, running the Scheduler populates the blank job dates.

Multiple jobs may have the same start date and time. The **Job Release Rule**, which you specify on the Shop Floor Control Parameters form before you run the Scheduler, controls the sequence in which the Scheduler releases these simultaneous jobs. The default job release rule releases jobs with the highest job priority values first.

## Operation Setup Time

See the Operation Setup Time Overview for information on how the Scheduler considers setup time and how you can minimize setup time by sequencing similar items (for example, blue part to blue part, red part to red part, etc.).

## Shifts and Holidays

By default, a resource is available for work 24 hours per day, seven days per week. Use these forms to refine the availability of your resources according to your facility's shifts and work schedules:

- Shifts: Assigned to resources to make the resource available for specified time intervals.
- Shift Exceptions: Assigned to resources to define periods of down time or overtime within a defined shift.
- Holidays: Downtime for all resources that are assigned to any shift.

See the topic on Handling Shift Overrun for information about preventing an operation from being scheduled within a shift interval where it cannot finish.

## Overlapping Operations

You can offset a series of operations to allow concurrent production.

See the topic on Defining Overlapping Operations for more information.

## Partially Complete Operations

Sometimes, an operation is partially complete when you start a Scheduler run (that is, the operation was not complete at the end of the last Scheduler run). When you start the Scheduler run, the system should allocate the same resource to the operation when the operation processing resumes. If a job was already started and operations are incomplete, the Scheduler starts processing that in-process job before other jobs that haven't already started.

## Output Analysis Methods

The Scheduler provides a set of output forms and reports that allow you to analyze the schedule output and determine the causes of bottlenecks, lateness, inconsistent utilization, etc.

See the topic on Analyzing Scheduler Output for more information.

## Differences from the PROGRESS Version

The table below summarizes the differences in the CloudSuite Business (SQL) scheduling functionality from the PROGRESS versions of SyteLine.

Objective	SyteLine (PROGRESS) Tasks	CloudSuite Business (SQL) Tasks
<p>1. Create operations.</p>	<p>Set up shop calendar, holidays, work center, department, and machine master files.</p> <p>Identify work centers and link them to departments and cells. Also establish if there are multiple machines within a work center.</p> <hr/> <p>In the operations for every manufactured item, identify either the work center or work center/machine needed for run times.</p>	<p>Set up scheduling shifts, holidays, resources, resource groups, departments, and work centers.</p> <p>Link scheduling shifts to resources and resources to resource groups.</p> <p>Link resource groups to work centers (optional).</p> <hr/> <p>In the operations for every manufactured item, identify the resource groups and the number of resources from that group the operation needs. Specify run times and setup times (optional) and split size (optional).</p>
<p>2. Identify critical job dates for scheduling.</p>	<p>For each job, identify the starting or ending date for the job and then select the scheduling method to use.</p> <p>You can use forward or backward scheduling. You can consider move and queue time. You can also add additional time to the start or end of the job.</p>	<p>For each job, accept the starting and ending date from MRP or APS (the dates default when you firm the planned order) or enter a starting date of your own.</p> <p>If you manually create a job, and you are using APS, use Get ATP/CTP to plan the job and calculate dates (this only plans the job; you will still have to run the Scheduler).</p> <p>Backward scheduling is NOT possible. APS planning, however, plans backward from the due date.</p> <p>The system uses finite scheduling unless you mark the resource group as infinite. The Scheduler ignores Queue time. You can add additional start and finish times to the Move and Finish fields of the first and last operation.</p>



Objective	SyteLine (PROGRESS) Tasks	CloudSuite Business (SQL) Tasks
3. Prioritize jobs	<p>To establish job priorities, you can manually give each job a priority number or you can allow the system to auto-calculate the priority using the due date or using critical ratio.</p> <p>The priority determines the sequence in which the job will be scheduled. Highest priorities are negative numbers (the lower the number, the higher the priority).</p>	<p>You can establish job priorities in the same way as in SyteLine (PROGRESS). However, the new system does not calculate negative priority numbers--everything past due is set to priority 0.</p> <p>Additional methods for setting priorities are also available:</p> <ul style="list-style-type: none"> <li>• At the job level, you can use job release rule options.</li> <li>• At the operation level, you can use the sequence or selection rule options.</li> </ul>
4. Schedule jobs.	<p>You can schedule a specific job or you can perform global scheduling.</p>	<p>You schedule all jobs on the whole floor for a specified period of time.</p> <p>To plan a single job, use Get ATP/CTP (if you are using APS).</p>
5. Troubleshoot scheduling problems.	<p>Use the load displays to identify work centers that are over capacity.</p>	<p>Use the Scheduler output analysis forms to identify late jobs and causes.</p>
6. Sequence and dispatch work.	<p>Establish different sort criteria for all work centers. Assign the sort criteria to each work center. After scheduling, you can use the Resource Group Sequencing form to refine the schedule.</p> <p>Sequencing has three zones that you define by work center: A frozen zone (no changes allowed), a sequenceable zone (you can arrange jobs for economical reasons), and a viewable zone (you can see all jobs in the future and can move them in).</p> <p>You can then allow the system to sequence the operations within the work center based on your sort criteria or you can manually sequence them yourself.</p>	<p>The Scheduler automatically sequences your work based on your sequence and selection rules.</p> <p>You can also create custom sequence and selection rules.</p> <p>You can manually change the sequence of work for a resource group.</p> <p>The end result is a prioritized and sequenced schedule.</p>

## Scheduling Steps

A typical process of using the CloudSuite Business Scheduler consists of the following steps.

- 1 Enter your real-world production data (items, routings/bills of material, shifts, resources, and resource groups).
- 2 Create work centers for tracking operation costs.
- 3 Define Shop Floor Control Parameters.
- 4 Define the production alternative on the Planning Parameters form.
- 5 Enter any demands (firm planned orders into jobs, production schedules, etc.).
- 6 Run the Scheduling activity. Typically, you will place this task on the Background Queue to be run nightly, with a one- or two-day horizon (to schedule the jobs and other demands firmed and created that day).
- 7 View the Background Task History form to make sure the Scheduling activity completed without errors. You can view the Trace messages for the scheduling run on this form.
- 8 Analyze the scheduler output to identify the problems in the schedule.  
See "Analyzing Scheduler Output" on page 120.
- 9 Solve the problems. For example, add overtime for the resource or re-prioritize the jobs on the Global Priority Settings form.
- 10 Rerun the Scheduling activity.
- 11 Print the Resource Group Dispatch List and give it to your shop floor to implement.

**Note:** Other steps, such as running the Planning activity, follow the scheduler steps. See the topics MRP Steps and APS Steps for more information.

## How Event-based Scheduling Works

The Scheduler creates a simulation of what will happen given all the conditions and data you provide to it. When running this simulation, the Scheduler views all events that happen at a given time. Then it moves forward to the next point in time where any events occur. Thus, each time you run the schedule, all demands (jobs, estimates, production schedules, MPS orders, and APS planned orders) are rescheduled.

After the scheduling run is complete, the Scheduler generates output data that summarize how well your simulated schedule performed. For example, if an operation was idle for an hour, the summary information helps you determine why (for example, maybe the required resource was busy). You can then adjust your data to make the schedule more efficient, such as by adjusting the start date of an earlier job to free the resource faster. When the schedule results are acceptable, you can print a resource dispatch list to give to your shop floor personnel to execute the schedule.

### About the Scheduler Trace Log

The Trace log records all events the Scheduler processes (when the Trace log is configured to record at the "Extensive" detail level on the Shop Floor Control Parameters form). In your day-to-day Scheduler

activities, the trace log is useful only for troubleshooting. However, it serves as a good step-by-step illustration of how the Scheduler addresses each event in a schedule. Therefore, the events for the example in this help topic are illustrated in a format similar to what you would see in the trace log (they have been simplified for clarity in this example).

## Event Processing Example

In this simple example, observe the Scheduler's view of the events. Assume these conditions:

- Item BK-110 has a routing with one operation, Oper110.
- The operation Oper110 requires a resource from resource group ST1.
- ST1 contains one resource, Crew1. The resource is on-shift for the time illustrated in the example.
- Operation Oper110 has a run duration of 15 minutes. Run duration is the time to complete a load on the operation. Depending on the Scheduler Rule defined on the operation, this could represent a fixed time or the time per piece. In this example, the run duration represents the time per piece.
- Job110-0000 for BK-110 is released on 2/27/2004 at 8:00 a.m. for a quantity of 3.
- The schedule starts on 2/27/2004 at 8:00 a.m.

Event	Description
SCHEDULE TIME ADVANCE TO 02/27/2004 8:00:00	The Scheduler moves to the time the first events occur (the schedule itself may have been set to start earlier).
02/27/2004 8:00:00 START OF JOB ARRIVAL EVENT FOR JOB Job110-0000 RELEASING LOADS FOR JOB Job110-0000 CREATING LOAD 1, SIZE 3 OPERATION Oper110, SELECTED AS FIRST	The job is released and the Scheduler places the job quantity into a unit called a load. In most situations, the load contains the entire job quantity (in some cases the job quantity can be broken into several loads). The first job operation in the routing is identified.
02/27/2004 8:00:00 START OF OPERATION EVENT PROCESSING OPERATION Oper110, LOAD 1 OF JOB Job110-0000 SCHEDULING END OF MOVE FOR OPERATION AT 02/27/2004 8:00:00	If any Move time had been defined for this operation, the Scheduler would have calculated its duration here. In this example, the operation is not defined with any Move time.
02/27/2004 8:00:00 START OF OPERATION EVENT PROCESSING OPERATION Oper110, LOAD 1 OF JOB Job110-0000 REQUESTING RESOURCE GROUP ST1 REQUESTING RESOURCE Crew1 FROM GROUP ST1 ALLOCATION NOT COMPLETE	The Scheduler forces the first operation event to delay allocating the resource until the resource can check its request queue for any pending requests. A request is entered into the resource's request queue.  See "Using Scheduler Rules" on page 101 for more information about request queues.  This delay covers the possibility that a higher-priority operation arrives at the same time as a lower-priority operation, allowing the more critical operation to allocate the resource.

Event	Description
<p>02/27/2004 8:00:00            START OF RESOURCE FREE CHECK EVENT FOR RESOURCE Crew1            PROCESSING OPERATION Oper110, LOAD 1 OF JOB Job110-0000            ALLOCATING 1 UNITS FROM RESOURCE GROUP ST1            CANCELING REQUEST FOR RESOURCE GROUP ST1            CANCELING REQUEST FOR RESOURCE Crew1 FROM GROUP ST1            ALLOCATING RESOURCE Crew1 FROM GROUP ST1            ALLOCATION COMPLETE            SETUP NOT NECESSARY OR OF ZERO DURATION            SCHEDULING END OF SERVICE FOR OPERATION AT 02/27/2004 8:45:00</p>	<p>The Crew1 resource checks its request queue for any pending requests and finds the request from OperBK001's load.            The Scheduler allocates the Crew1 resource from the ST1 resource group and calculates the time when the operation will be complete.</p>
<p>SCHEDULE TIME ADVANCE TO 02/27/2004 8:45:00</p>	<p>The Scheduler moves to the time when the next events occur.</p>
<p>02/27/2004 8:45:00            START OF OPERATION EVENT            PROCESSING OPERATION Oper110, LOAD 1 OF JOB Job110-0000            FREEING 1 UNITS OF RESOURCE GROUP ST1            FREEING RESOURCE Crew1 FROM GROUP ST1            RESOURCE Crew1 IS NOW IDLE            SCHEDULING END OF COOL FOR OPERATION AT 02/27/2004 8:45:00</p>	<p>The operation completes and releases ("frees") the Crew1 resource.            The Crew1 resource is now idle and available for any other operations to allocate it.            If any Finish time (that is, cooling time) had been defined for this operation, the Scheduler would have calculated its duration here. In this example, there is no additional post-operation processing.</p>
<p>02/27/2004 8:45:00 START OF RESOURCE FREE CHECK EVENT FOR RESOURCE Crew1 REQUEST QUEUE EMPTY</p>	<p>When a resource is freed, it checks whether any other operations have requested it while it was busy. In this example, there are no pending requests for the resource.</p>
<p>02/27/2004 8:45:00            START OF OPERATION EVENT            PROCESSING OPERATION Oper110, LOAD 1 OF JOB Job110-0000            END OF PROCESS FOUND SELECTING NEXT OPERATION            END OF PROCESS FOR LOAD 1 OF JOB Job110-0000</p>	<p>Each operation specifies the next operation in the routing. In this example, the Scheduler finds no next operation, so it completes the job.</p>

Event	Description
0 LOADS OUTSTANDING JOB Job110-0000 COMPLETE	
SCHEDULE HALTED BECAUSE THERE WERE NO MORE JOBS TO PROCESS SCHEDULE END AT 02/27/2004 8:45:00	The Schedule is now complete.

## Using Scheduler Rules

The Scheduler uses three types of rules to allocate resources for working on an operation:

- **Sequencing Rule:** Sequences the waiting requests in a resource's request queue. For example, "loads for operations with the earliest due dates are listed first." By default, the rule is First In First Out (FIFO). You define this rule for each resource on the Resources form.
- **Selection Rule:** Controls how the resource selects the next waiting request from the queue. For example, "select the load with the least setup time based on the first downstream operation." By default, no selection rule is defined and requests are selected in the sequence they appear in the request queue. You define this rule for each resource on the Resources form.
- **Resource Group Member Allocation Rule:** Controls how the Scheduler selects a resource from a resource group to allocate to a load. For example, "select the resource that has been idle the longest." By default, the resource listed first in the resource group record is selected first. You define this rule for each resource group on the Resource Groups form.

**Note:** When a load arrives at an operation, the Scheduler requests all required resources in the required resource group, forcing each to check its request queue only after all loads scheduled at the same time have arrived. This prevents a lower-priority load from allocating a resource because it arrives when the resource is available, even though a load with higher priority is scheduled to arrive at the same time.

You are not required to use all of these rules. In most cases, the default rules are appropriate and efficient; however, you can define the rules as needed to model your production situations accurately.

### Using Custom Scheduler Rules

If the provided rules do not meet your needs, you can write and custom rules and integrate them into the Scheduler. For each of the rules described above, several rule positions are reserved for your custom rules.

See "Writing Custom Scheduler Rules" on page 130 for more information.

## Scheduler Batching

Using the CloudSuite Business Scheduler, you can group several potentially different items on different jobs into a batch and process that batch through, for example, an oven or a paint booth. After the batch is processed, the different jobs then continue on their own routing.

Batching affects only the Scheduler, not the Planner.

### About Batching

Each batch definition describes how batches are formed, including a routing that processes the batched parts. The Operations forms includes a batch definition field. Any operation on which a batch definition is specified is referred to as the batch operation. In a jobs or production schedule routing, an operation (the batch operation) references a batch definition when the job or production schedule can be combined with other jobs or productions schedules for processing. This causes batches to be formed, based on the rules defined on the Batch Definitions form, and transfers control to the batch definition routing. At the end of the batch definition routing, the job or PS returns to its original routing and continues processing as normal.

You can use the Batched Productions form to define specific jobs and production schedules to be batched together. These jobs and production schedules are combined into batches based on the definition and not on the rules defined on the Batch Definitions form. The routing from the batch definition is copied and attached to the batched production, similar to the way current operations are copied to job operations when jobs are released. A batch routing cannot have batches defined on its routing (no batches of batches) and cannot define materials, status, or costing; these are defined on the batch operation.

If the **Batch Definition** field on the appropriate operations form specifies a batch operation, then in the Scheduler the job or production schedule proceeds to the batch routing, ignoring the resource requirements and operating times on the operation. If batches are in process, they are placed at the correct operation in the batch routing based on the time recorded on the Batch Definition Operations form. For example, if the batch operation has an operation time of 10 hours, and 4 hours are reported against it, at the beginning of the Scheduler run the batched operation that is 4 hours from the beginning of the batch routing is identified as the current operation, and LSTATUS000 records are created to indicate that situation.

The Planner uses the operation as defined, and does not use the batch routing. Planning (operations and material), data collection, and costing are unaffected by this process, because there are still resource requirements and data collection processed against the batch operation.

### Defining and Running System-Created Batches

To define and run batches:

- Use the Batch Definitions form to tell the Scheduler how batches should be formed, including how jobs or production schedules will be batched together and when a batch will be released to be processed.

On this form, you define rules to specify how batches are formed:

- Define a separation rule to determine which jobs are grouped together. Use the Separation Attributes form to maintain a list of the characteristics of items that can be separated into batches.

- Define a release rule to determine how an arriving job affects the quantity for a forming batch load, that is, when a batch will be released to be processed.
- Define an override rule, if needed, to indicate the conditions under which a forming batch load should be released during an override check.
- Click the **Operations** button to open the Batch Definition Operations form, where you define operations attached to the batch definition.
- On the Items form, use the batching attributes fields to define how the batches are separated, or grouped together, and when they will be released.
- On the Job Operations, Estimate Operations, Current Operations, Standard Operations, Production Schedule Item Operations, and Production Schedule Release Operations forms, use the new **Batch Definition** (and Batch ID, where applicable) field to note where a batch will be formed and where it will start processing on the batch routing.

## Defining and Running User-Defined Batches

Use the Batched Productions form to create a user-defined batch. Specify the contents of the batch, which include specific released jobs and production schedule releases.

When you create batched productions, a copy of the batch operations is created and attached, much like jobs have an attached copy of the current operations for an item. Click the **Operations** button to open the Batched Production Operations form to define operations that use the batched production definitions.

These utility forms are also available for dealing with batched productions: Change Batched Production Status Utility, Batched Production Removal Utility, and Batched Production Creation Utility.

## Viewing Batch Summary Information

Use the Batch Summary form to see the batching results of a Scheduling run: which jobs and production schedules were batched together, how long jobs waited to be batched, and how long they were batched together.

# Scheduling Operations

## About Operation Setup

## About Operation Run Time - Planning and Scheduling

The CloudSuite Business Scheduler and APS calculate the duration of an operation considering setup time, run time, move time, and finish time. Run time is the processing step of the operation.

**Note:** MRP considers operation run time indirectly through the lead time calculations from the Lead Time Processor.

An operation's run time begins after these events:

- Finish time from the previous operation in the routing completes.
- Move time from this operation completes.
- Setup time (adjusted for the operation's Efficiency value) from this operation completes.

The operation may require resources from Labor, Machine, and Other (for example, fixtures) resource groups. If an operation specifies multiple resource groups that are of different types, the operation must specify the Schedule Driver. The Schedule Driver determines whether to use labor hours or machine hours to drive the schedule. If the resource groups are all of the same type, the run hours for all the required resource groups drive the plan and schedule.

To determine how to plan or schedule the operation, the system:

- 1 Divides the hours per-piece value by the number of resources required from the resource group of the Sched Driver type.
- 2 Multiplies the result by  $(100 / \text{Efficiency})$  and places the adjusted value in the **Run Duration** field.
- 3 Applies the **Run Duration** to all required resources.

If the operation's **Use Fixed Schedule** option is selected, the system applies the **Fixed Sched Hours** and does not divide the hours by the number of resources.

Costing considers the run hours for all labor resource groups and adds the fixed machine overhead cost. The hours entered on the job operation are the total hours required for 1 piece.

### Planning and Scheduling Example

Suppose an operation specifies the following information:

Resource Group	Group Type	Qty Resources	Hours Per Piece
WorkersA	Labor	2	1 labor hour
Drill	Machine	1	2 mach hours
FixtureA	Other	1	(2 mach hours)

- Schedule Driver is Labor.
- Efficiency is 80.0.
- Job quantity is 6.

Given this information, the system performs these steps:

- 1 Divides the labor hours per piece value by the number of labor resources required:  $1 \text{ hour} / 2 \text{ resources} = 0.5 \text{ hours}$ . If the Schedule Driver had been Machine, the calculation would have used the machine resource values:  $2 / 1 = 2 \text{ hours}$ .
- 2 Multiplies the resulting value by the Efficiency:  $0.5 * (100 / 80.0) = 0.625 \text{ hours}$ .
- 3 Places the adjusted value in the operation's **Run Duration** field.
- 4 Multiplies the **Run Duration** by the job quantity to find the total time requirement:  $0.625 * 6 = 3.75 \text{ hours}$ .



The system applies 3.75 hours of run time to each of the two labor resources, the machine resource, and the other resource for this operation. When the operation is planned or scheduled, the four resources also undergo any move time, setup time (also adjusted for Efficiency), and finish time.

### Costing Example

Using the data from the planning and scheduling example above, suppose the operation's **Labor Run Rate** is 15.00 and the **Fixed Machine Overhead** rate is 10.00. The cost of the operation would be calculated as follows:

$$1 \text{ labor hour per piece} * 6 \text{ pieces} * 15.00 * (100 / 80.0) + 10.00 = 122.50$$

Adding or removing resources/resource groups to or from an operation does not affect the operation's cost.

### Operation Setup Time Overview

Setup time is the portion of the operation spent preparing the resource for performing the operation (such as tooling, proofing, or any other work not proportional to the units produced). The system factors the setup time into the duration of the operation.

Depending on your type of business, resources may always need to be set up. Or, they may need to be set up only when changing from working on one type of item to another. Likewise, the setup time could be a fixed value or it could vary depending on the type of item.

### About Posted Setup Times

In APS and in the Scheduler, when you post setup time against a job with a job transaction, APS and Scheduler consider the posted time and plan or schedule the operation using the adjusted setup hours. For example, if the normal setup time on an operation is 10 hours, and you post setup time of 3 hours against the job/operation, the operation will be planned and/or scheduled using 7 hours.

### About Setup Time in APS

APS uses only the Setup hours value specified on the **Standards** tab on the Operations form, divided by Efficiency (also specified on the operation). This value is intended to be an average setup time. The Scheduler uses a more detailed setup value, which the rest of this help topic describes.

### Defining the Setup Resource Group

On the operation, in the **Setup Resource Group** field, define a resource group from which to allocate the resource to be set up. The Scheduler will use the resource allocated from this group to determine the setup time based on the criteria you define (described later in this help topic). If you leave the **Setup Resource Group** field blank, the operation incurs no setup time.

**Note:** The Scheduler loads the calculated setup time onto all resources allocated to the operation. For example, if the operation allocates three resources, one of which is the setup resource, and the calculated setup time is 1 hour, all three resources are loaded with 1 hour of setup time.

## Defining When to Apply Setup Time

To specify the situations in which the operation requires the resource to be set up, select the appropriate **Setup Rule** on the operation record:

- **Always:** This operation always needs the resource to be set up, regardless of the previous item the resource was working on.
- **Basis:** This operation needs the resource to be set up only when the previous operation using the resource was working on a different item or setup group (group of related items).
- (User-defined rules 3-39): You can write custom setup rules to determine when the resource should be set up.

When the **Setup Rule** field is set to **Basis**, select the appropriate **Setup Basis** on the operation record:

- **Item:** Apply the setup time when the previous operation using the resource was working on a different item.
- **Setup Group:** Apply the setup time when the previous operation was working on an item that is a member of a different Setup Group than the item this operation is working on. You define setup groups on the Setup Groups form. For example, you might group all red bike frames in a "RED" setup group and blue bike frames in a "BLUE" group. The setup time could be based on the time needed to set up the resource from painting red frames to painting blue frames.

**Note:** Each operation can have only one setup basis, but you may define many setup basis configurations. For example, the bike assembly operation could have a setup basis of "Type of Handle Bar," and the bike frame operation could have a "Color" basis.

## Defining the Amount of Setup Time

You can define a fixed setup time or use a calculated value. You can select the **Setup Time Rule** on the operation record to represent either situation.

- **Fixed:** Apply the value from the Setup Hrs field on the operation, divided by Efficiency.
- **Setup Matrix:** look up a value from a table that defines setup time based on changing the resource's setup from working on one type of item to working on another. The value the system applies from the setup matrix is NOT divided by Efficiency.

## Example: Setup Time

The following example illustrates how the Scheduler applies setup time for three different operations producing three different items. Assume these conditions:

- There are three items, each with a single operation. All three operations require the same resource:
  - Adult Bike: Member of setup group Adults. Setup time 2.5 hours.
  - Kids Bike, Blue: Member of setup group Kids. Setup time 0.5 hours.
  - Kids Bike, Red: Member of setup group Kids. Setup time 1.5 hours.
- The Setup Matrix "Adults-to-Kids" determines setup time when the setup group changes as follows.

From	To Adults	To Kids
<DEFAULT>	5.0	6.0

From	To Adults	To Kids
Adults	0.2	1.0
Kids	2.0	0.3

**Note:** The "<DEFAULT>" row accounts for the situation where there is no operation scheduled prior to the current one.

The table below shows the Setup Rule and Setup Time rule for each operation and how the setup time is applied based on these rules. Items are listed in the sequence in which they arrive at the resource.

### Setup/Setup Time Rules and Resulting Setup Time Application

Field/Pair	Setting	Setting	Setting	Setting	Setting
Setup Rule:	Always	Basis	Basis	Always	Basis
Setup Basis:	Item	Item	Group	Group	Group
Setup Time Rule:	Fixed	Fixed	Fixed	Matrix	Matrix
Setup Matrix:	N/A	N/A	N/A	Adults-to-Kids	Adults-to-Kids
	–	–	–	–	–
Kids Bike, Red	1.5	1.5	1.5	6.0	6.0
Kids Bike, Blue	0.5	0.5	0	0.3	0
Kids Bike, Blue	0.5	0	0	0.3	0
Adult Bike	2.5	2.5	2.5	2.0	2.0
Kids Bike, Blue	0.5	0.5	0.5	1.0	1.0

### Creating a Setup Matrix

Use the Setup Matrix form to define the required setup time for changing a resource's setup from working on one type of item to another.

Just as you can define the **Setup Basis** on the operation for specifying when to apply setup time, you define the **Setup Basis** for the setup matrix to apply its setup time. A setup matrix can be based on the item, setup group, or resource group changing.

**Note:** You may only specify setup matrices that match the **Setup Basis** specification on the Job Operations form. For example, if the current job operation record specifies Item as the **Setup Basis**, then, in the **Setup Matrix** field, you may only choose a matrix whose **Setup Basis** specification is also Item.

## Setup Matrix: Item Basis Example

It takes 1 hour to set up the resource from polishing bike frames (item 0001) to polishing handlebars (item 1000). It takes 1.5 hours to set up from polishing handlebars to polishing bike frames. The resource is not initially set up to paint either item. To represent this situation, you must define four records for your setup matrix:

- bike frames to handlebars
- handlebars to bike frames
- <DEFAULT> to bike frames
- <DEFAULT> to handlebars

The <DEFAULT> identifier handles the cases where the current "From" index is not defined at the beginning of the scheduling run. This code is needed in this example because the resource is not initially set up to paint any item. You should define a "default" record for each To Item possibility. In this example, the resource only processes two items. You could use the <DEFAULT> identifier if the resource might process items other than 0001 and 1000, but you do not want to define a setup time for each combination. If the resource might process other items, you would define additional records: bike frames to <DEFAULT>, handlebars to <DEFAULT>, and <DEFAULT> to <DEFAULT>.

To set up this example setup matrix:

- 1 On the Setup Matrix form, select **Actions > New**.
- 2 In the **Setup Matrix ID** field, enter an identifier for this setup matrix. For example, specify **Frame-Handlebar**.
- 3 In the **Setup Basis** field, select **Item**.
- 4 In the **From Item** field, specify **<DEFAULT>** (with the < and > symbols).
- 5 In the **To Item** field, select the frame item number, **0001**.
- 6 In the **Setup Time** field, enter a "generic" setup time to apply regardless of which To item causes the first setup. For example, specify **0.0001**. For the <DEFAULT> record, you can enter a very small value, such as 0.0001, but it must be non-zero in order for the resource setup status to be changed.
- 7 Select **Actions > Save** to save this From-To record.
- 8 Select **Actions > New**.
- 9 In the **Setup Matrix ID** field, select the **Frame-Handlebar** record you created in the previous steps.
- 10 In the **From Item** field, specify **<DEFAULT>** (with the < and > symbols).
- 11 In the **To Item** field, select the handlebars item number, **1000**.
- 12 In the **Setup Time** field, enter a generic setup time, such as **0.0001**.
- 13 Select **Actions > Save**.
- 14 Select **Actions > New**.
- 15 In the **Setup Matrix ID** field, select the **Frame-Handlebar** record you created in the previous steps.
- 16 In the **From Item** field, select a valid From item number. For this example, select the bike frame item number, **0001**.
- 17 In the **To Item** field, select the To item number. For this example, select the handlebars item number, **1000**.
- 18 In the **Setup Time** field, enter the number of setup hours for this from-to sequence (for example, 1.00 hour).

**19** Select **Actions > Save**.

**20** Repeat steps 14-19 to set up a record to represent 1.5 hours of setup time with the From Item as item number 1000 and the To Item as item number 0001.

To configure an operation to use this setup matrix, you must select the appropriate fields on the **Resources** tab of the Current Operations form. Select **Item** in the **Setup Basis** field and **Setup Matrix** in the **Setup Time Rule** field. In the **Setup Matrix** field, select the **Frame-Handlebar** identifier for the matrix you created in the above steps.

## Setup Matrix: Setup Group Basis Example

A resource is initially set up to paint RED bike frames, and it takes 15 minutes to change the setup for painting BLUE frames. It takes 10 minutes to change the setup from painting BLUE frames to painting RED frames.

To represent the situation in this example, you must enter seven records for your setup matrix:

- Red to Blue
- Blue to Red
- <DEFAULT> to Red
- Red to <DEFAULT>
- <DEFAULT> to Blue
- Blue to <DEFAULT>
- <DEFAULT> to <DEFAULT>

**Note:** Define a "default" setup time value for each situation where either the From or the To item is not a member of one of the defined setup groups.

- 1** On the Setup Groups form, define a BLUE setup group and a RED setup group.
- 2** On the **Controls** tab of the Items form, reference the appropriate Setup Group on each blue or red bike frame item record.
- 3** On the Setup Matrix form, select **Actions > New**.
- 4** In the **Setup Matrix ID** field, enter an identifier for this setup matrix. For example, enter **RedBlue**.
- 5** In the **Setup Basis** field, select **Setup Group**.
- 6** In the **From Setup Group** field, select the **RED** setup group you created in the previous steps.
- 7** In the **To Setup Group** field, select the **BLUE** setup group.
- 8** In the **Setup Time** field, enter **0.25**.
- 9** Select **Actions > Save**.
- 10** Repeat these steps to create the remaining six records (to represent the From-To situations listed above) for the RedBlue setup matrix.

To configure an operation to use this setup matrix, you must select the appropriate fields on the **Resources** tab of the Current Operations form. Select **Group** in the **Setup Basis** field and **Setup Matrix** in the **Setup Time Rule** field. In the **Setup Matrix** field, select the **RedToBlue** identifier for the matrix you created in the above steps.

## Setup Matrix: Resource Group Basis Example

Following is an example setup matrix for three items, where:

- Mold heat up time = 1 hour.
- Insert change from 1 to 3 = 0.25 hours.
- Fixture change from Item 2 to Item 3 = 0.25 hours.

To implement this example, enter records that represent the following to/from relationships:

From / To	Item 1	Item 2	Item 3	<UNKNOWN>
<UNKNOWN>	2	2	2	2
Item 1	0	1.25	0.25	2
Item 2	1.25	0	0.25	2
Item 3	0.25	1.25	0	2

The time that is a grouping of all like type mold changes and the initial mold change when the setup of a Mold is not known is represented by <UNKNOWN>. The time includes fixture change, insert change, and mold heat up time.

Following is an example of three molds, labeled Mold 1, Mold 2, and Mold 3. The track resource group, named TrackResGroup, is designated as the Setup Resource Group. Instead of item-to-item setup times, there were mold-to-mold setup times.

From / To	Mold 1	Mold 2	Mold 3	<UNKNOWN>
<UNKNOWN>	1	1	1	1
Mold 1	0	0.75	1.5	1
Mold 2	1.25	0	2	1
Mold 3	0.75	1.75	0	1

## About Operation Overlapping and Splitting

### Defining Overlapping Operations

This topic applies to APS and the Scheduler.

You can allow the starting date/time of an operation to overlap the starting date/time of the previous operation in the routing. This feature allows for parallel processing of the original load of items across multiple operations.

You express the overlapping of two operations with an "offset" hours value representing the number of run time hours the previous operation must complete before this operation can start.

For example, suppose Operation 10 starts at 1:00 and has 4 hours of run time. Operation 20 has an Offset of 0.5 hours. This means Operation 20 can begin at 1:30, which is 0.5 hours after Operation 10's run time starts.

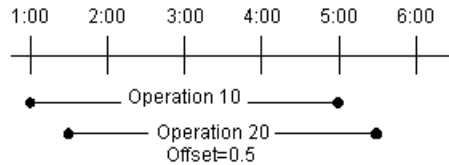

The Offset value begins when run time starts. Run time starts after Setup time is complete.

## Differences between Scheduler and APS Processing

**Note:** MRP supports overlapping operations indirectly if you use the Lead Time Processor to calculate the item lead time and the Use Offset Hours option is enabled.

The planning and scheduling activities process overlapping operations slightly differently. See the Overlapping Operations topics for more information.

## Overlapping Operation Processing - Scheduler

You define overlap on an operation to represent the number of run hours the previous operation must complete before this operation can start. When you run the Scheduling activity, the Scheduler splits the job with overlapping operations into smaller loads. This allows a resource to work on one smaller load at a time and complete it faster. The Scheduler generates split load sizes in terms of a number of items or a number of loads, based whether the operation is using fixed schedule hours, as follows:

If Use Fixed Schedule is...	The Scheduler splits the loads using this calculation
Selected	$\# \text{ loads} = \text{Fixed Sched Hours} / \text{Offset}$
Cleared	$\text{load size} = \text{Offset} / \text{Run Duration}$

**Note:** While the system will let you, we don't recommend defining offset with fixed time operations. Each split load will use the entire operation time if there is a fixed time defined. This will make the operation take much longer than it should.

Each load attempts to allocate the resource or resources associated with the operation according to the resource's selection rule. After allocating a resource and completing any setup and run time, the load moves immediately to the next operation without waiting for the original job's quantity to be completed.

## Uneven Split Sizes

The job quantity may not be evenly divisible by the split size. If this occurs, the Scheduler processes the uneven remainder of parts by creating a new load.

For example, assume the job quantity is 100 and the load split size is 25. The number of whole loads is determined by dividing 100 by 25, which results in four loads of 25 each. But if the load split size

were 30, there would be 3 whole loads of 30 and a remainder of 10. The Scheduler places the remaining items in a load of 10.

### Setup Time Consideration

The Offset value begins when run time starts. Run time starts after Setup time is complete.

For example, suppose you have a load moving through Operation 10 and Operation 20. Operation 10 has 1 hour of setup time and 1 hour of run time. Operation 20 has an offset of 0.5 hours. This offset value will cause the order to split into two loads (2 loads = 1 hour run time / 0.5 offset hours per load). Operation 10 starts by processing load 1 through 1 hour of setup and then 0.5 hours of run. At this point, load 1 proceeds immediately to Operation 20 and load 2 starts at Operation 10.

**Note:** If Operation 20 also had setup time defined, load 1 would start undergoing setup time only after being completed at Operation 10. You cannot start the setup time on a subsequent operation before the load is completed at the previous operation.

### Multiple Resources in Resource Group

If a resource group contains multiple resources, the loads can potentially allocate all resources and begin processing at the operation concurrently. For example, if you have 2 loads moving through Operation 10, where the required resource group contains 2 resources, each load can allocate one of the two resources (according to the selection rules).

### How the Scheduler Recombines the Split Loads

The Scheduler combines the original load back together:

- When, after processing an operation that allows overlapping, it encounters an operation that does not allow overlapping (that is, an operation with Use Offset Hrs=No).
- When it reaches the last operation in a routing.

See "Overlapping Operations Example" on page 112 for an illustration of a possible overlap situation.

### Example: Overlapping Operations

The diagram below illustrates a possible overlapping operation situation, assuming each operation requires a different resource group. Each resource group contains a single resource that is on-shift for the time represented in the example. The steps following the diagram explain the details.



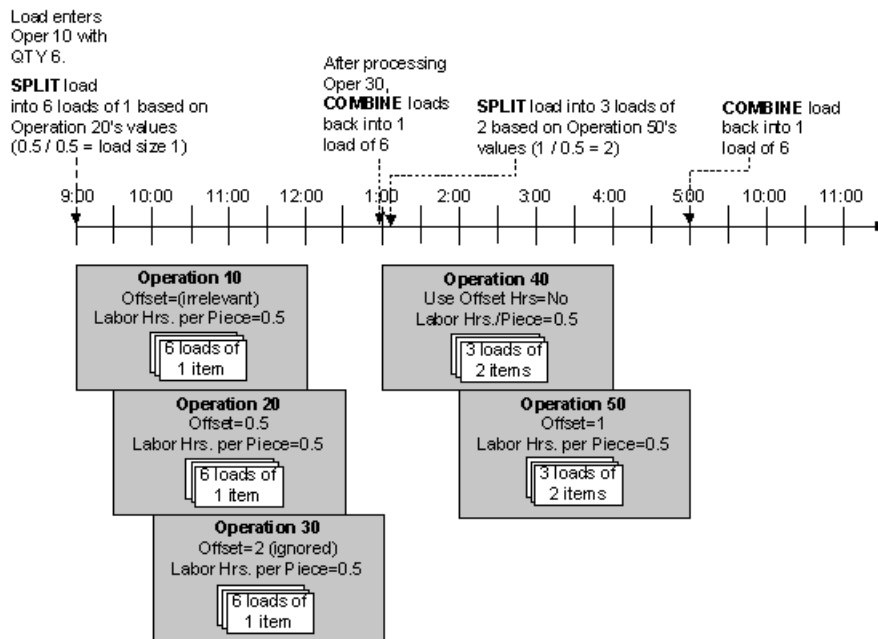

- 1 The load arrives at operation 10 with a quantity of six parts. The Scheduler splits the load into smaller loads of one item each based on the next operation's Offset and cycle time (in this case,  $0.5 / 0.5 = \text{load size of } 1$ ).

**Note:** The Scheduler keeps the loads divided into the load size calculated at the beginning of any series of overlapping operations.

- 2 The six loads compete for the resource at operation 10 according to the defined resource selection rules. One of the loads allocates the required resource. The resource does not begin processing the next load until it completes the first one (however, if there were multiple resources in the resource group, the other loads would allocate the available resources and begin processing).
- 3 When the first load is complete, it immediately moves to operation 20. Operation 20's Offset value is 0.5 hours, so it starts processing the first load at 9:30 (30 minutes after operation 10 started).
- 4 The Scheduler ignores operation 30's Offset value of 2 hours because the offset value always remains the same throughout a series of overlapping operations. Operation 30 starts at 10:00 (30 minutes after Operation 20 started).
- 5 The Scheduler keeps the loads divided until after it completes operation 30. Then, at 1:00, it combines them back into one load of 6 because the next operation (operation 40) does not allow overlapping.
- 6 Operation 40 starts after operation 30 completes.
- 7 Operation 50 allows overlapping. Therefore, starting at operation 40, the Scheduler splits the load into 3 loads of 2 items, based on the Offset value and Labor Hours Per Piece value from operation 50.
- 8 Operation 50's Offset value is 1 hour, so it starts at 2:00. The load remains divided into the load size the Scheduler calculated at the beginning of this series of overlapping operations.
- 9 After operation 50 completes, the Scheduler combines the loads back into one load of 6 items.

The same example displayed in the Resource Gantt Chart display looks like this (each operation bar represents a load):

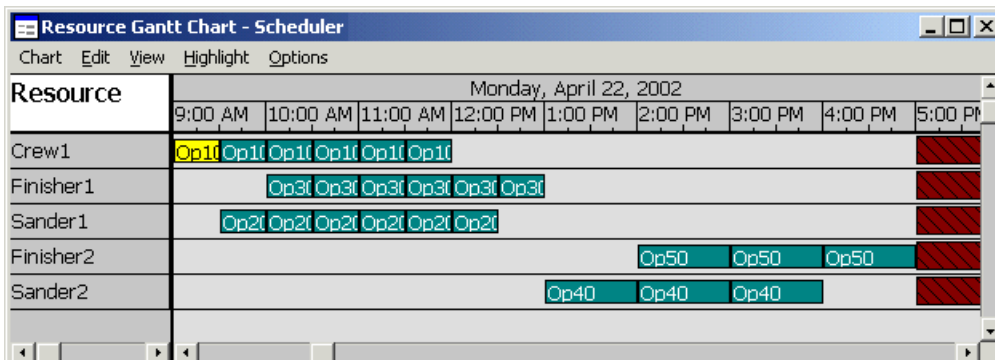

## Splitting a Job Across Resources

Within a single operation, the Scheduler can split a load into smaller loads to allow multiple resources to work on the items. This processing is basically the same as with overlapping operations, except it occurs only within a single operation.

For example, if you have an operation that grinds 100 items, and you have five grinders, you could specify that the Scheduler break the load up into 5 groups of 20.

To enable operation splitting, specify the load split size in the **Split Size** field on the Operations form.

**Note:** A **Split Size** of 0 disables operation splitting. Also, the Scheduler ignores operation splitting if it is defined on an overlapped operation.

When a load arrives at an operation that can be split, the Scheduler processes the operation as follows:

- 1 The original load quantity is broken into loads of the specified split size. The last load may be partial, depending on the quantity.
- 2 The loads are processed using the resource's **Selection Rule**. All resources in the associated resource group have the potential of selecting each load.
- 3 After all loads have completed the operation, the Scheduler accumulates them into one load.

## Defining Offset Hours

To define an operation's offset:

- 1 Open the Operations form and select the desired operation.
- 2 Select the **Standards** tab.
- 3 In the **Offset** field, specify the number of run time hours the previous operation must complete before this operation can start.
- 4 Save the changes.

---

## Creating Outside Operations

If the actual work on an operation is performed at a location other than your shop floor, you must perform special steps to capture the status of the operation for accurate APS, scheduling, and costing. If you do not represent and manage an outside operation properly, the effects can ripple down through subsequent processes, resulting in an over-conservative plan and schedule.

To capture outside operation status, you can:

- Use the Post Job Transactions form to post time or quantity remaining on the operation (the **Operation Scheduling** parameter on Shop Floor Control Parameters determines whether hours or pieces remaining are posted). You must specify the operation's work center as "Outside" on the **Scheduling** tab on the Work Centers form. Use this method only if you have accurate status information for the outside operation.
- Cross reference the outside operation to one or more purchase order line items. Time remaining on the operation is calculated using the purchase order line item due dates.

Because you may not necessarily have accurate information to post time or quantity remaining for an outside operation, we recommend you model outside operations using the cross-referenced purchase order method (although you can use that method and also post time or quantity to the operation if you have the status information).

This topic describes how to set up the cross-referenced purchase order method.

- 1 To set up the outside operation, you must create a purchased material and issue it to the operation. Follow these steps:
  - a On the Scheduling Shifts form, create a scheduling shift consisting of one shift interval that starts on Sunday at 00:00 hours and ends Saturday at 24:00 hours (7 days x 24 hours). You will be using an infinite resource group to represent this process. Therefore, you need a 24x7 shift to ensure that the planning and scheduling programs process the infinite resource consistently (scheduling ignores the shift and considers the resource always infinite, while APS considers the resource infinite only while on-shift).
  - b On the Resources form, follow these steps:
    - Create a new resource for the outside operation.
    - On the **General** tab, you can accept the default values for the fields.
    - Select the **Shifts** tab. In the **ShiftID#1** field, select your 24x7 scheduling shift.
  - c On the Resource Groups form, follow these steps:
    - Create a new resource group.
    - In the **Infinite Capacity After** field, enter **0**. This sets the resource to infinite capacity for planning purposes.
    - Select the **Infinite** field to set the resource to infinite capacity for scheduling purposes.
    - Select the **Resources** tab. Add your outside resource as a member of the group.
  - d On the Work Centers form, follow these steps:
    - Create a work center to use for outside operations. You can use the same work center for more than one outside operation.

- On the **Scheduling** tab, select the **Outside** field. Defining the work center as **Outside** signals the planning and scheduling processes to perform special calculations so you don't have to enter the time the parts have been away from the shop. The Outside work center also captures the cost in the "Outside" GL account you set up on the Product Codes form.
  - Select the **Resource Groups** tab. Add the infinite resource group you created earlier in this procedure.
- e On the Job Operations form, follow these steps:
- In the **WC** field, select your outside work center.
  - In the **Fixed Schedule Hours** field (if you are using fixed schedule hours) or the appropriate hours per piece/pieces per hour field, enter the number of hours that corresponds to the normal lead time for this outside operation.
- Note:** Regardless of whether you specify **Fixed Schedule Hours**, the system temporarily switches the operation to fixed schedule hours during the planning or scheduling run.
- Select the **Resources** tab and verify that your infinite resource group is displayed. If it is not, select it now.
  - Select the **Costs** tab and enter **0** in all the costing rate fields. The material you issue to the operation will capture the cost of the outside operation.
- f On the Items form, follow these steps:
- Create an item to represent the item your outside operation will be providing.
  - In the **Source** field, select **Purchased**. This allows you to cross reference the material on the bill of material to a PO.
  - In the **Type** field, select **Other**. This **Type** code prevents the system from creating planned orders for this item (instead, you will use the cross-reference feature).
  - Consider how to track cost for this purchased item. To apply the cost of the outside operation only to this order, set the **Cost Type** to **Actual**, set the **Cost Method** to **Specific**, and select the **Lot Tracked** field.
- g On the Job Materials form, follow these steps:
- Find the job and your outside operation.
  - Add a material record for the outside operation item.
  - In the **Quantity** field, enter **1**.
  - Select the **Lot** field (so the quantity is 1 per lot).
- 2** To process the outside operation:
- a On the Unposted Job Transactions form, enter a transaction to move the WIP from the previous operation to the outside operation.
  - b Use the Post Job Transactions form to post the transaction.
  - c On the Job Operations form, make sure all operations previous to the outside operation are marked as Complete.
  - d Create a cross-referenced purchase order line item. We recommend you do this as soon as you start the operation. Follow these steps:

- Open the Job Materials form.
  - Find your outside material record.
  - Select the **Source** tab.
  - In the **Ref** field, select **Purchase Order**.
  - Click the **Source** button to create the cross reference.
  - Click the **Source** button again to display the Purchase Order Lines form.
  - On the **General** tab, set the **Due Date** of the cross-referenced PO line item to the date you expect to receive the outside materials from the vendor.
  - Select the **Costs** tab. Specify the correct cost on the purchase order.
- e Physically send the purchase order and materials to your vendor.
- f Adjust the PO line item due date as necessary.
- 3 Use the Purchase Order Receiving form to receive the outside materials from the vendor.
  - 4 The receipt transaction automatically opens the Job Material Transactions form. On this form, issue the materials to the job.
  - 5 After you issue the materials, the Post Job WIP Move Transactions form opens automatically. On this form, record this operation complete and move the materials to the next operation.

## Calculating Duration for Outside Operations

If you are not using the cross-referenced purchase order method, and are posting time on the operation, the system plans the outside operation Run Duration normally (based on posted time/quantity).

The system considers the due date of the outside operation's cross-referenced PO line item when it calculates the operation duration. Basically, the system may reduce or extend the outside operation's duration, provided the operation is the first open (that is, not posted Complete) operation in the routing.

- If all of an outside operation's cross-referenced PO lines are Complete or Filled, the system sets the **Run Duration**, **Move**, **Queue**, and **Finish** fields to **0**.
- If any PO line has a status of Ordered, and the operation has been started (that is, operation quantity received is greater than 0), the system adjusts the Run Duration as shown in the table below.

If...	Then...
This Operation is the first open operation in the routing OR The normal Run Duration value (based on posted time/qty) is greater than the Due Date/time of the latest cross-referenced PO line item - Current Time.	The system sets the Run Duration to Due Date/time of the latest cross-referenced PO line item - Current Time. The <b>Move</b> , <b>Queue</b> , and <b>Finish</b> hours fields are set to <b>0</b> If the adjusted duration is less than 0, the system sets the operation's Run Duration to 0. NOTE: The time value on the Due Date comes from the <b>Supply Time</b> field on the Planning Parameters form.

If...	Then...
Operations previous to this one exist, and this operation has received at least one piece.	Set the Run Duration to the earlier of (1) the normal duration, based on posted time and quantity or (2) the Due Date/time of the latest cross-referenced PO line item - Current Time.
Operations previous to this one exist, and this operation has not received at least one piece.	Set the Run Duration to the normal duration, based on posted time and quantity.

## Resequencing Scheduled Jobs and Operations

You can adjust the sequence of scheduled jobs and operations for specific resources or for all resources in a specific resource group.

- 1 Run the Scheduling activity (to adjust the work sequence, you must have run this activity at least once).
- 2 Open the desired sequencing form:
  - To adjust the work sequence for a single resource, open the Resource Sequencing form.
  - To adjust the work sequence for all resources within a specific resource group, open the Resource Group Sequencing form.
- 3 In the **Resource** field or **Resource Group** field, select the resource or resource group you want to adjust the schedule for.
- 4 In the **Dispatch Interval** field, enter the number of hours into the future to retrieve schedule records. The interval starts from the start date of the last run of the Scheduling activity.
- 5 Click the Filter-In-Place button to retrieve the schedule records.
  - On the Resource Sequencing form, the grid displays all jobs and operations the resource is scheduled to perform for the displayed period.
  - On the Resource Group Sequencing form, the grid displays the jobs and operations the resource group is scheduled to perform (no specific resource is indicated).
  - Records are shown in the grid in the order the Scheduler sequenced them, usually in order by start date.
- 6 To manually adjust the sequence of records in the grid:
  - a Choose a schedule record by selecting a row in the grid.
  - b Click the **Move Up** or **Move Down** buttons to move the record up or down in the list.
  - c When you are finished changing the sequence, select **Actions > Save**.
- 7 Optionally, instead of manually adjusting the sequence, you can use the Resource Sequencing Sort Setup form to define automatic sort priorities:
  - a Open the Resource Sequencing Sort Setup form.
  - b Specify a resource.

- c Create up to six sort criteria by selecting a table, selecting a field name, entering a field label, and specifying either ascending sort or descending sort.
- d Use the **Move Up** and **Move Down** buttons to set the priority of the sort criteria.
- e Save the record.
- f Open the Resource Sequencing form.
- g Click **Sort** to apply the sort specifications defined on the Resource Sequencing Sort Setup form.

## About Global Priority Settings: Due Date vs. Critical Ratio

Use the Global Priority Settings form to assign priorities to jobs either by using critical ratio calculations or based on the number of calendar days until the job is due. The priority number represents the job's priority (priority cannot be less than zero). Use the Scheduler's **Job Release Rule** to specify how the priority value is interpreted during scheduling. The Global Priority Setting does not reassign new priorities to jobs with frozen priorities (from the Job header).

You must set priorities before running APS Planning or the Scheduler. The system plans and schedules jobs and loads them into the resource groups in order of priority.

The differences between Due Date and Critical Ratio options are discussed below.

### Due Date

The system simply sets each job's priority to the number of days until the job is due + 1000. A job due 3 days from now would therefore have a higher priority (1003) than one due 6 days from now (1006).

**Note:** The number 1000 is added to the priority because the Scheduler cannot process negative priority values (priority can be from 100-9999, leaving 0-99 open for you to freeze job priorities on the Job Orders form).

### Critical Ratio

The system assigns a priority to jobs based on the amount of work yet to be done on the job in relationship to the number of days until the job is due. The basic calculations used are:

- If job not past due:  $(\text{critical ratio} * 100) + 1000$
- If job past due:  $(\text{days remaining until due date} - \text{days of process time remaining} / \text{average work hours per day}) + 1000$

**Note:** This utility uses the work center's scheduling shift in its critical ratio calculations (the scheduling shift selected in the Work Center form's **Shift ID** field).

# Analyzing Scheduling Output

## Analyzing Scheduler Output

The Scheduler generates output data when you run the Scheduling activity. You can view the results graphically and statistically, using graphs and reports that depict system and component performance.

### Output Forms and Reports

- Resource Utilization
- Resource Group Utilization
- Resource Group Load Profile
- Resource Schedule
- Resource Group Schedule
- Resource Queue
- Resource Group Queue
- Resource Gantt Chart
- Demand Summary Scheduler
- Resource Dispatch List Report
- Resource Final Queue Report
- Resource Summary Report
- Projected Item Completions Report
- Production Exceptions Report
- Projected Item Completions by Resource Report
- Resource Load Profile
- Resource Group Summary Report
- Demand Detail Scheduler
- Resource Sequencing
- Resource Group Sequencing

To display output data on reports, you must specify Information Collection options on various Scheduler forms before running the Scheduling activity. This section summarizes the information collection options you can select for each report, for resources, resource groups, and jobs.

If the **Use Planning Output for Scheduling** planning parameter is selected, running the APS Planning activity (rather than the Scheduling activity) populates these Scheduler output forms and reports:

- Resource/Resource Group Dispatch List report
- Resource Utilization
- Resource Group Utilization
- Resource Schedule
- Resource Group Schedule



- Resource Sequencing
- Resource Group Sequencing
- Resource Gantt Chart - Scheduler

The remaining Scheduler output forms and reports do not function when the **Use Planning Output for Scheduling** parameter is selected.

## Specifying Output Data for Resources

On the Resources form, select the appropriate Information Collection options to collect data for reports and output forms:

- Summary Data
- Schedule Data
- Final Queue Data
- Load Profile Data.

The table below describes how to use the information collection options to answer specific questions on a report or output form:

When you want to know...	Select this field...	And use this output form...	Or this report...
What the load is for a resource.	Load Profile Data, Summary Data	Resource Load Profile, Resource Utilization	Resource Load Profile Report, Resource Summary Report
Which resources are bottlenecks.	Load Profile Data, Summary Data	Resource Utilization	Resource Summary Report
What is in the request queue for a resource at the end of the Schedule run.	Final Queue Data	Resource Queue	Resource Final Queue Report
The schedule for each resource.	Schedule Data	Resource Gantt Chart, Resource Schedule	Resource Dispatch List
Sequence of work at a resource.	Schedule Data	Resource Gantt Chart, Resource Schedule	Resource Schedule Report, Resource Dispatch List
Required production at a resource.	Schedule Data	None	Projected Item Completion by Resource Report

## Specifying Output Data for Resource Groups

The table below describes how to use the information collection options to answer specific questions on a report or output form:

When you want to know...	Select this field...	And use this output form...	Or this report...
The schedule for each resource group.	Schedule Data (for each member resource)	Resource Group Schedule	Resource Group Dispatch List
What the load is for a resource group.	No selection necessary	Resource Group Load Profile, Resource Group Utilization APS	Resource Group Load Profile Report, Resource Group Summary Report
Which Resource Groups are bottlenecks.	No selection necessary	Resource Group Utilization APS	Resource Group Summary Report
What is in the request queue for a resource group at the end of the Schedule run.	Final Queue Data (for each member resource)	Resource Group Queue	Resource Final Queue Report
Required production at a resource group.	Schedule Data (for each member resource)	None	Projected Item Completion by Resource Group
Sequence of work at a resource group.	Schedule Data (for each member resource)	Resource Gantt Chart, Resource Group Schedule	Resource Group Dispatch List

## Specifying Output Data for Jobs

There are no information collection fields for jobs; all relevant information is collected automatically.

The table below describes how to answer specific questions on a report or output form:

When you want to know...	Use this output form...	Or this report...
Which jobs are late.	Demand Summary - Scheduler	Production Exceptions
Why jobs are projected to be late.	Demand Detail - Scheduler, Job Operations	Production Exceptions with Detail
When will the job complete.	Demand Detail - Scheduler	Production Exceptions
When will an operation complete.	Demand Detail - Scheduler, Job Operations	Resource Group Dispatch List, Resource Dispatch List

## Using the Resource Gantt Chart on a Windows Client

If you are running the Resource Gantt Chart on a Windows client, follow these steps to specify which resources you want to analyze, and to change your display options.

When you open this form, the Select Data dialog box is displayed.

- 1 To display all resources, select **All Resources**, or select a resource list to display.

To create a new list of resources:

- Click **Add**. A list of resources is displayed in the Add a Resource Selection dialog box.
- Specify a name for your new list.
- To add a resource to your list, select it and click **>**.
- When all the resources you want to display are added to the list, click **OK** to return to the Select Data dialog box.
- Select your new list.

**2** In the **Alternative** field, accept the default selection of zero to work with the production data, or select an alternative plan number.

**3** Define the Gantt chart horizon in the **Start** and **End** date fields.

**4** Click **OK** to populate the Gantt Chart with the selected data.

**5** Use these options in the chart:

- To edit an existing list in the Select Data dialog box, select the list, click **Edit** and follow the steps above. To delete a list, select it and click **Delete**.
- To change the list of displayed resources in the Resource Gantt Chart at any time, right-click anywhere in the chart and choose **Select Data...** from the menu.
- Right-click anywhere in the Gantt chart display to change display options. You can change these options:
  - **Secondary Selection**: Use this option to indicate the type of logic used when you select a particular bar in the display.
    - **None** (the default value): Shows only the selected utilization bar in yellow.
    - **Same Operation**: Shows all operations working on the same load. This option is useful if the operation is interrupted due to a shift change and the load is reallocated to another resource. All utilization bars for this operation/load are shown in yellow.
    - **Same Job**: Shows all utilization bars for the same demand (job, production schedule, MPS order, planned order, etc.) in yellow.
  - **Bar Text**: Use this option to change the text that is displayed on the utilization bars. By default, the job number displays on the bar. You can display the operation number, the item number, or no text.
  - **Time Scale**: The data is displayed in a one-hour granularity.
  - **Highlight**: Display all utilization bars that meet specified criteria in a specific color. For example, you can color red all bars associated with late jobs or color blue all bars for a large job quantity. See the next section for more information.

**6** Use highlighting to color all chart bars that meet specified criteria. For example, you can color red all bars associated with late orders or color blue all bars for a large order quantity.

To apply an existing highlight:

- a Right-click anywhere in the Gantt chart and select **Highlight**. The Edit Highlights form displays.
- b Select the highlight, then click **OK**.

To create and apply a new highlight:

- a Right-click anywhere in the Gantt chart and select **Highlight**. The Edit Highlights form displays.
- b Click **Add** to open the Add a Highlight form.
- c Specify the highlight name.
- d Click the **Add** button. The Add a Criterion form displays.
- e Enter a criterion (rule) for applying color to a bar. A criterion consists of: type, comparison operator, value, color, and optional substring comparison settings.

Criteria are rules associated with a highlight on the Resource Gantt Chart. You can add multiple criteria to a highlight. Therefore, for the graphical bar to be colored according to the highlight, the resource must meet the highlight's various criteria.

Complete these fields; see the description of each field for more information):

- **Type**
- **Comparison**
- **Value**
- **Color**
- **Compare Substring**
- **Starting Character**
- **Length of Comparison**

- f Click **OK** until you return to the Resource Gantt Chart form.
- g To apply your new highlight, select the name of your highlight from the **Highlight** right-click menu option.

For data items that are text strings, you can select the option to compare a subset of the string. You can also specify the color to apply to bars for which the comparison is true. If a highlight includes multiple criteria and all criteria must be true for a bar to be colored, you define the color in the Add Highlights dialog box.

For example, if bars associated with orders for more than 20 units are to be colored blue, the rule would have the type Order Size, the comparison operator ">", and the value 20.

## Analyzing and Adjusting Resource Gantt Chart Data (Windows Client)

The Gantt chart display consists of one row for each resource named in the selection. The display is organized as follows:

- Green bars represent periods of utilization for the resource shown in the left column.
- Red bars represent down time (for example, off-shift periods or shift-exceptions).
- When you select a bar, the color changes to yellow.
- Blank areas of a row represent idle time for the resource.

**Note:** When the Gantt chart displays load for infinite resources, the load bars might display stacked on top of one another. As a result, some of them may not be visible.

Click on a resource utilization bar to view details about the operation the resource is performing and the demand it is working on during the time period. Click on a downtime bar to view details about the reason for and duration of the downtime.

This picture shows three resources, each working on a single operation in a routing.

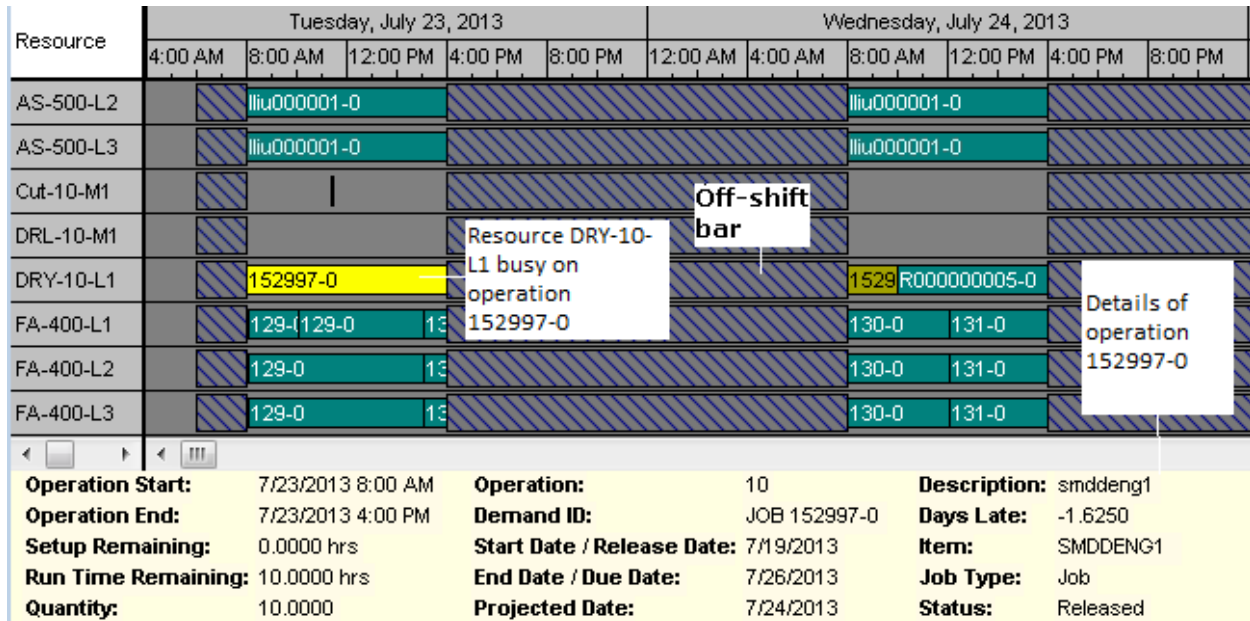

### Manually Adjusting Gantt Chart Data

The Resource Gantt Chart - Scheduler form allows direct manipulation of the bars shown in the Gantt chart. Available adjustments are:

- Changes to the start and/or end of an operation
- Moving an operation to a different resource
- Freezing a job or operation.

Manual adjustments are available whether the schedule is created by a normal Scheduler run or through the **Use Planning Output for Scheduling** planning parameter. Once manual schedule adjustments are made through the Gantt Chart, the results are reflected in all Scheduling analysis forms and reports available to the user, including:

- Resource/Resource Group Load Profile - Scheduler
- Resource/Resource Group Utilization - Scheduler
- Resource/Resource Group Schedule
- Resource/Resource Group Summary Report

## Using the Resource Gantt Chart on a Web Client

If you are running the Resource Gantt Chart on a Web client, follow these steps to specify which resources you want to analyze, and to change your display options.

When you open this form, the Select Gantt Data dialog box is displayed.

**1** To display all resources, select **All Resources**.

To select a specific resource list to display, clear the **All Resources** check box to enable the **Selection Name** field. Select a resource list.

To create a new list of resources that will be included in the **Selection Name** field:

- Click **Selections** to display the Resource Gantt Chart Selections form.
- Click the **New** button in the tool bar.
- Specify a name for your new selection.
- In the Resources grid, click and select a resource to include in your list. Specify a sequence number for it.
- To add more resources, click the **New** button in the tool bar. Use the **Up** and **Down** buttons to move the resources up and down in the list.
- When all the resources you want to display are added to the list, save your changes and close the form.
- In the Select Gantt Data form, select your new list in the **Selection Name** field.

**2** In the **Alternative** field, accept the default of zero to work with the production data, or select an alternative plan number.

**3** In the **Start Date** and **End Date** fields, define the date range for which chart data is loaded. The planning or scheduling horizon dates are used as the defaults.

**4** In the **Customer**, **Item**, **Material**, and **Shift** fields, accept the default selections, which were specified on the Resource Gantt Chart Selections form, or specify new records.

**5** Click **OK** to populate the Gantt Chart with the selected data.

**6** Use these options in the chart:

- To edit an existing list in the Select Data dialog box, select the list, click **Edit** and follow the steps above. To delete a list, select it and click **Delete**.
- To change the list of displayed resources in the Resource Gantt Chart at any time, click the Select Data icon in the top left corner of the chart.
- To change display options, click the Options icon in the top left corner of the chart. You can change these options:
  - **Secondary Selection**: Use this option to indicate the type of logic used when you select a particular bar in the display.
    - **None** (the default value): Shows only the selected utilization bar in yellow.
    - **Same Operation**: Shows all operations working on the same load. This option is useful if the operation is interrupted due to a shift change and the load is reallocated to another resource. All utilization bars for this operation/load are shown in yellow.
    - **Same Job**: Shows all utilization bars for the same demand (job, production schedule, MPS order, planned order, etc.) in yellow.

- **Bar Text:** Use this option to change the text that is displayed on the utilization bars. By default, the job number displays on the bar. You can display the operation number, the item number, or no text.
  - To change the time scale of the chart, use the Zoom In and Zoom Out icons in the top left corner of the chart.
- 7** Use highlighting to color all chart bars that meet specified criteria. For example, you can color red all bars associated with late orders or color blue all bars for a large order quantity.
- To apply an existing highlight to the chart, click the Edit Highlights icon in the top left corner of the chart, and select the highlight name.
- To create and apply a new highlight:
- a Click the Edit Highlights icon in the top left corner of the chart and select **Edit**. The Gantt Highlights form displays.
  - b Click the **New** button in the tool bar to add a highlight.
  - c Specify the highlight name.
  - d Click in the grid to add a criterion (rule) for applying color to a bar. A criterion consists of: sequence, type, comparison operator, value, and optional substring comparison settings.
  - e Criteria are rules associated with a highlight on the Resource Gantt Chart. You can add multiple criteria to a highlight. Therefore, for the graphical bar to be colored according to the highlight, the resource must meet the highlight's various criteria.
- Complete these fields:
- **Type**
  - **Comparison**
  - **Value**
  - **Compare Substring**
  - **Starting Character**
  - **Length of Comparison**
- f Select **Must meet all criteria** if all the listed criteria must be met in order for a bar to be highlighted in the chart. If this field is not selected, only one or more criteria in the list must be satisfied.
  - g Click the color box to display the standard color dialog box, where you can select a color. This color is used as the highlight color for a bar that meets the specified criteria.
  - h Use the **Up** and **Down** buttons to change the sequence of the criteria.
  - i Save your changes and close the form to return to the Resource Gantt Chart form.
  - j To apply your new highlight, select the name of your highlight from the **Highlight** right-click menu option.

## Analyzing and Adjusting Resource Gantt Chart Data (Web Client)

The Gantt chart display consists of one row for each resource named in the selection. The display is organized as follows:

- Green bars represent periods of utilization for the resource shown in the left column.
- Red bars represent down time (for example, off-shift periods or shift-exceptions).
- When you select a bar, the color changes to yellow.
- Blank areas of a row represent idle time for the resource.

**Note:** When the Gantt chart displays load for infinite resources, the load bars might display stacked on top of one another. As a result, some of them may not be visible.

Click on a resource utilization bar to view details about the operation the resource is performing and the demand it is working on during the time period. Click on a downtime bar to view details about the reason for and duration of the downtime.

### Manually Adjusting Gantt Chart Data

The Resource Gantt Chart - Scheduler form allows direct manipulation of the bars shown in the Gantt chart. Available adjustments are:

- Changes to the start and/or end of an operation
- Moving an operation to a different resource
- Freezing a job or operation.

When you move a bar in the chart, the Gantt Edit Operation form is displayed. The "from" resource, start date, and end date indicate the original information from the chart. Specify new values for these fields:

- **To Resource** is the resource where you want to move the operation.
- **To Start Date** is the new start date of the operation
- **To End Date** is the new end date of the operation.

Click **OK** to begin the validation process. If the manual adjustment causes an operation to become out of sequence, or the resource being moved to doesn't match the resource being moved from, error messages display. To continue, either override the errors and allow the adjustment, or cancel the adjustment.

Manual adjustments are available whether the schedule is created by a normal Scheduler run or through the **Use Planning Output for Scheduling** planning parameter. Once manual schedule adjustments are made through the Gantt Chart, the results are reflected in all Scheduling analysis forms and reports available to the user, including:

- Resource/Resource Group Load Profile - Scheduler
- Resource/Resource Group Utilization - Scheduler
- Resource/Resource Group Schedule
- Resource/Resource Group Summary Report



## Manually Adjusting the Resource Gantt Chart

**Note:** This topic applies only to the Resource Gantt Chart - Scheduler form, when used in the Windows client. To manually adjust the bars when you are using the chart in the Web client, see "Using the Resource Gantt Chart - Web Client" on page 126.

### Adjusting Chart Bars

Initiate an adjustment by performing one of the following:

- Left click in the middle of a bar and drag to move the bar without changing its duration. The bar can be moved to a new time on the same resource or to a different resource.
- Left click on the left end of a bar and drag to change its start date while leaving the end date fixed. The bar will remain on the same resource.
- Left click on the right end of a bar and drag to change its end date while leaving the start date fixed. The bar will remain on the same resource.

After adjusting a bar, a dialog displays, allowing you to verify the new settings and fine-tune the adjustment. You can adjust the start date, end date, and resource allocation. The system validates that the start date and end date are valid and that the end date is later than the start date. Click **OK** to complete the schedule edit, and click **Cancel** to revert to the bar's original position.

**Note:** You can access this dialog box directly by right-clicking and selecting **Edit Operation**.

### Splitting and Merging

It may be necessary to split a resource usage bar into two pieces in order to complete a desired schedule edit.

To split a usage bar:

- Right-click on a bar and select **Split Operation**.
- The resource bar is now divided into two equal pieces, the first retaining the start code and the second retaining the end code of the original bar. Adjust the split pieces as needed.

To combine separate pieces of a single operation, or to reverse a split:

- Select any piece of the operation.
- Right-click and select **Merge Operation**. This combines the pieces of the currently selected resource usage and combines them into a single usage with the start date of the earliest piece and a duration equal to the combined durations of the merged pieces.

### Saving Manual Adjustments

Instead of saving schedule changes immediately to the application database, you must right-click and select **Save Schedule**. Once selected, all pending changes are saved to the database. If you attempt to exit the form, or load a different dataset, without first saving the current schedule, a warning message displays. This allows you to try out schedule changes before committing them to the database. Saving bulk changes will occur within a transaction to ensure data integrity. The save is rolled back if the original schedule records have been altered since being originally loaded (for example, another user edited some of the same schedule records). The user control will also communicate with the CloudSuite

Business form logic to allow schedule changes to be saved using the standard collection save command from WinStudio.

### Freezing

To freeze a job or operation:

- Select the job or operation.
- Right-click and select **Freeze Job** or **Freeze Operation**.

This action will cause SCHEDOP000 records to be created for all scheduled operations for the current job. Frozen operations will be displayed with a white fill pattern to distinguish them from other bars.

To unfreeze all operations from a frozen job or operation:

- Select an operation.
- Right-click and select **Un-Freeze Job** or **Un-Freeze Operation**.

**Note:** Operations may also be frozen from the Resource Sequencing form.

If you are populating the Resource Gantt Chart - Scheduler form with Scheduler data (the **Use Planning Output for Scheduling** field is not selected), then you may freeze entire jobs, or single operations within a job as long as that operation is not in the middle of a routing. Furthermore, these adjustments will be honored by the system the next time you run the Scheduler.

**Note:** When you freeze an operation, all preceding operations in that job are also frozen.

Some CloudSuite Business users will not use the APS Scheduler, but will instead populate the schedule output tables through the **Use Planning Output for Scheduling** planning parameter. In this mode, the contents of the schedule output tables are derived from the results of the most recent APS Planner run. Because of this, the step in the planning process where SCHEDOP000 records are generated is bypassed. Manual schedule edits made in the Gantt chart while operating in this mode will have no impact on subsequent planner runs. To resolve this problem, you can freeze and unfreeze operations for a job in the Gantt chart. Once frozen, operations can no longer be manually edited unless they are first unfrozen.

## Customizing Scheduling Rules

### Writing a Custom Scheduler Rule

On certain CloudSuite Business forms, several positions of Scheduler rules are listed as user-defined. For example, positions 24-39 of the Sequence Rule are reserved for user-defined rules. A user-defined rule is a custom piece of logic that you write in one or more custom C++ functions. User-defined rules allow you to model your unique scheduling situations that the standard rules may not address.

For example, the fragment below from the initialization function `ucini1` installs a load-ranking function for Sequence Rule 39:

```
double myrule39(LOAD*);
void ucini1()
{
    sedfrk(39, myrule39);
    /* Install other user-defined rules here. */
}
double myrule39(LOAD*)
{
    /* Insert your custom logic for myrule39 here. */
}
```

For a complete description of each user-callable Scheduler function, see the *Scheduling Customization Guide*, available for download from our Support site.

## Naming Conventions, Arguments, and Return Values

To execute correctly, custom functions must accept the proper arguments and return the proper value for the type of rule. The names of these functions must not conflict with the names of standard user-callable functions. You must make your custom functions accessible to the Scheduler by calling installation functions in the initialization function `ucini1`. See these topics for these details for the following rules:

- "Writing Custom Sequence Rules" on page 169
- "Writing Custom Selection Rules" on page 167
- "Writing Custom Resource Allocation Rules" on page 164
- "Writing Custom Setup Rules" on page 171
- "Writing Custom Job Release Rules" on page 162
- "Writing Custom Batch Separation Rules" on page 173
- "Writing Custom Batch Release Rules" on page 175
- "Writing Custom Batch Override Rules" on page 176

## Usercode Directory

User code compiled for the Scheduler applies to all alternatives in the database. The install procedure creates a subdirectory named `USERCODE` that contains the user code support files. You should create a subdirectory beneath this one with the same name as your SQL database to hold your user code source files. The Scheduler also looks for the user code DLL file (`USER.DLL`) in this directory.

## Writing for UNICODE

The Scheduler uses Unicode to support international string issues. To write code that can be conditionally compiled for Unicode, MBCS, or neither, follow these programming guidelines:

- Use the `_T` macro to code literal strings conditionally to be portable to Unicode. For Example: `psqlda = dboptab (_T("MYBOM"), p_ssgvar->sgctrl.scprrtds, DB_FETCH)`

- When you pass strings, pay attention to whether function arguments require a length in characters or a length in bytes. The difference is important if you're using Unicode strings.
- Use portable versions of the C run-time string-handling functions. See the section on String Manipulation in the Microsoft Visual C/C++ documentation for a complete list and for further information.

For Example:

- `_tcscopy` instead of `strcpy`
  - `_tcsncpy` instead of `strncpy`
  - `_tcscmp` instead of `strcmp`
  - `_tcsncmp` instead of `strncmp`
  - `_tcscat` instead of `strcat`
  - `_tcsncat` instead of `strncat`
  - `_tcschr` instead of `strchr`
  - `_stprintf` instead of `sprintf`
- Use the following data types for characters and character pointers:
    - `TCHAR` Where you would use `char`.
    - `LPTSTR` or `TCHAR *` Where you would use `char*`.
    - `LPCTSTR` Where you would use `const char*`.

### Integrating the Custom Rules into the Scheduler

After you have written your custom rules, you must link them into the standard system.

### Scheduler User-Callable Function Names

This topic lists the user-callable support functions for the Scheduler. You can use these functions to customize the Scheduler functionality. For a complete description of each user-callable Scheduler function, see the *Scheduling Customization Guide*, available for download from our Support site. When creating new Scheduler functions, make sure not to use any of the listed function names.

Function	Description (blank description indicates function not supported)
mtcurrem	
aaveqlen	
aaveqlen	
aaveqtim	
aaveqtim	
acurqlen	
acurqlen	

Function	Description (blank description indicates function not supported)
agchgdst	
agchgst	
agcprq	
agcprqct	
agcpvct	
agcpveh	
agcrblck	
agcrblck	
agcrbreak	
agcrbreak	
agcrbusy	
agcrbusy	
agcridle	
agcridle	
agcrmaint	
agcrmaint	
agcroff	
agcroff	
agctrldf	
agctrldf	
agctrsl	
agctrsl	
agdfvs	
agdfvs	
agdist	
agflrq	
agflrqct	
agonblck	
agonblck	
agonbreak	

## Scheduling Shop Floor Activity

---

<b>Function</b>	<b>Description (blank description indicates function not supported)</b>
agonbreak	
agonbusy	
agonbusy	
agonidle	
agonidle	
agonmaint	
agonmaint	
agrqchk	
agsgvct	
agsgveh	
agsignal	
agvalsgdf	
agvalsgdf	
agvalsgsl	
agvalsgsl	
agvbck	
agvbck	
agvblvh	
agvbreak	
agvbreak	
agvbump	
agvbumpoff	
agvbumpon	
agvbusy	
agvbusy	
agvcap	
agvcap	
agvcrq	
agvcurshift	
agvcurshift	

Function	Description (blank description indicates function not supported)
agvidle	
agvidle	
agvmaint	
agvmaint	
agvoff	
agvoff	
agvrtdf	
agvrtdf	
agvrtsl	
agvrtsl	
agvsgclr	
agvsr	
agvsr	
agvtmeos	
agvtmeos	
alsgdf	
alsgdf	
alsgsl	
alsgsl	
batchid	
batchid	
batchnam	
batchname	
beta	
binomial	
caveqlen	
caveqlen	
caveqtim	
caveqtim	
ccurqlen	

## Scheduling Shop Floor Activity

---

<b>Function</b>	<b>Description (blank description indicates function not supported)</b>
ccurqlen	
conprob	
convblock	
convblock	
convbreak	
convbreak	
convbusy	
convcap	
convcap	
convcurshift	
convcurshift	
convmaint	
convmaint	
convoff	
convoff	
convseg	
convseg	
convstat	
convstat	
convtmeos	
convtmeos	
convutil	
convutil	
covbusy	
cpfind	
cpfind	
cpfind	
csavos	Return the current average for an observed statistic.
csavts	



<b>Function</b>	<b>Description (blank description indicates function not supported)</b>
cschd0	Schedule a system event on the internal event calendar.
csched	Schedule a system event on the regular event calendar.
cscits	
csclos	Collect an observation for an observed statistic.
csclos	Collect an observed for an observed statistic.
csclts	Collect an observation for a time-persistent value.
csclts	
cscvts	
csdlls	Delete a list.
csdlos	Delete an observed statistic.
csdlts	
csdsst	Disable statistics collection for a list.
cselep	Search the event lists for an entity.
cselfv	Search the event lists for the first entity scheduled for a given function.
cselnv	Search the event lists for the next entity scheduled for a given function.
cseinst	Enable statistics collection for a list.
csepea	Get the scheduled event address for an entity.
csepet	Get the scheduled event time for an entity.
csfsls	Get a pointer to the first entity in a list.
csgpls	Remove an entity from a list by pointer.
csgtls	Remove an entity from a list by number.
cshsos	Return histogram information for an observed statistic.
cshsts	
csinls	Determine whether an entity is in a list.
csinos	Initialize or clear an observed statistic.
csints	
csllsls	Get a pointer to the last entity in a list.

## Scheduling Shop Floor Activity

<b>Function</b>	<b>Description (blank description indicates function not supported)</b>
csmkls	Create and initialize a list with statistics.
csmkos	Allocate and initialize an observed statistic.
csmkts	
csmnos	Return the current minimum for an observed statistic.
csmnts	
CSMXLS	Create and initialize a list without statistics.
csmxos	Return the current maximum for an observed statistic.
csmxts	
csnew	Get a pointer to a new entity of the specified size.
CSNEW	Get a pointer to a new entity of the specified size.
csnoos	Return the current number of observeds for an observed statistic.
csnxls	Get a pointer to the next entity in a list.
cspfls	Place an entity into a list after another entity.
cspols	Place an entity into a list using a specified ordering.
csppls	Place an entity into a list before another entity.
csprls	Get a pointer to the previous entity in a list.
csptls	Place an entity into a list using the list's ordering.
cssdos	Return the current standard deviation for an observed statistic.
cssdts	
cssols	Sort a list.
csssls	Get a pointer to the time-persistent statistics for a list.
csszls	Get the current size of a list.
csterm	Terminate an entity pointer.
cswsls	Get a pointer to the observed statistics for a list.
ctrldf	
ctrldf	
ctrlsl	

Function	Description (blank description indicates function not supported)
ctrlsl	
cvchgst	
cvrqchk	
cvrtdf	
cvrtdf	
cvrtsl	
cvrtsl	
dbbdmp	Build a column (field) number map.
dbcltab	Close a database table.
dbcrtab	Create a database table.
dbdlrow	Delete a database row.
dbdltab	Delete a database table.
dbds2j	Convert a database date string to Julian.
dbfdcn	Find a column (field) number.
dbgtdm	Get the value of the column (field) based on column name.
dbgtdn	Get the value of the column (field) based on column number.
dbj2ds	Convert a Julian to database date string.
dbj2ts	Convert a Julian to database time string.
dboptab	Open a database table.
dbrdrow	Read a database row.
dbstcm	Set the value of the column (field) based on column name.
dbstcn	Set the value of the column (field) based on column number.
dbtblx	Check the existence of a database table.
dbtrtab	Truncate a database table (file).
dbts2j	Convert a database time string to Julian.
dbwrrw	Write a database row.
disprob	
earlang	

## Scheduling Shop Floor Activity

---

<b>Function</b>	<b>Description (blank description indicates function not supported)</b>
evalexp	Evaluate an expression.
expdfr	
exponential	
gama	
gedi2j	Convert date and time integers into a Julian representation.
gej2di	Convert a Julian representation into date and time integers.
gej2ds	Convert a Julian representation into a "MM-DD-YY HH:MM" form.
gest2j	Returns the current system time as a Julian representation.
getxcell	Get a value from an Excel spreadsheet.
getxcell	
gewkdy	Return the day of the week given a Julian representation.
gtcharat	
gtcharvr	
gtintat	
gtintvr	
gtrealat	
gtrealvr	
jobarriv	Specific load arrival time at operation.
jobarriv	
jobstart	Specific load start time at operation.
jobstart	
js04rp	Find the resource to be setup on setup operation.
js10df	Install a select operation selection function.
js10df	Install select operation selection function.
js10sl	Return the operation on select operation.
js13rp	Find the resource to be setup on setup/operation operation.

<b>Function</b>	<b>Description (blank description indicates function not supported)</b>
jsaloc	Allocate resources for an operation.
jsalrs	Allocate the nth resource/resource group on an operation.
jsavrs	Get the availability of the nth resource/resource group on an operation.
jsclst	Update load statistics during operation processing.
jsclst	Update load statistics during operation processing.
jscmjt	Return the step time of a load for an operation.
jscmst	Return the operation portion of step time of load for an operation.
jscmsu	Return the setup part of step time of a load for an operation.
jscqrs	Cancel requests for the nth resource/resource group on an operation.
jsdfar	Install an operation resource allocation function.
jsdfar	Install resource allocation function.
jsdfjs	Install an operation selection code evaluation function.
jsdfjs	Install function to process operation selection rule.
jsdfst	Install an operation step time function.
jsdfst	Install step time function.
jsfree	Handle all of the operation resource free phases.
jsfrhn	Free the handle returned by function jsavrs.
jsfrrs	Free the nth resource/resource group on an operation.
jsfsbt	Select the first operation on batch routing.
jsfsjs	Select the first operation on routing.
jsin01	Operation operation interrupt function.
jsinrs	Interrupt the use of a resource by a load.
jsname	Specific load current operation.
jsname	
jsnxbt	Select next operation after a batch routing.
jsnxjs	Select next operation in routing.

## Scheduling Shop Floor Activity

<b>Function</b>	<b>Description (blank description indicates function not supported)</b>
jspr01	Operation operation processing function.
jsrars	Retrieve resources preempted due to off shift or failure.
jsrqrs	Request the nth resource/resource group on an operation.
jsrsen	Reschedule end of operation after interruption.
jsscscen	Schedule the end of service for an operation.
jswtsr	Determine whether setup required.
lddrtime	Specific load dropoff time at operation
lddrtime	
ldduedate	Specific load due date
ldduedate	
ldinsys	Number of loads in the system.
ldinsys	
ldlngjstep	Specific load's longest remaining operation
ldlngjstep	
ldmcralloc	Specific load has MCR allocated (1=yes, 0=no)
ldmcralloc	
ldoptime	Specific load's operation time at operation
ldoptime	Load's operating time at this operation.
ldordnml	Specific load's job's number of load
ldordnml	Load's job's number of loads.
ldordsize	Specific load's job size
ldordsize	Load's job size.
ldpktime	Specific loads pickup time at operation
ldpktime	Specific loads pickup time at operation
ldprior	Specific load priority
ldprior	Specific load priority
ldprtime	Specific load's processing time at operation
ldprtime	Specific load's processing time at operation
ldqutime	Specific load's wait time at operation

<b>Function</b>	<b>Description (blank description indicates function not supported)</b>
ldqutime	Specific load's wait time at operation
ldreldate	Specific load's job's release date
ldreldate	Specific load's job's release date
ldresalloc	Specific load has resource allocated (1=yes, 0=no)
ldresalloc	Specific load has resource allocated (1=yes, 0=no)
ldrmjsteps	Specific load's remaining number of operations
ldrmjsteps	Specific load's remaining number of operations
ldrmpertime	Specific load's remaining processing time
ldrmpertime	Specific load's remaining processing time
ldsttime	Specific load's setup time at this operation
ldsttime	Specific load's setup time at this operation
ldtimewip	
ldtimewip	
ldwipalloc	
ldwipalloc	
lkupname	Specific load's part setup matrix name.
lkupname	Specific load's part setup matrix name.
loaddone	Number of load completed.
loaddone	Number of load completed.
loadid	Specific load ID.
loadid	Specific load ID.
loadproc	Number of loads processing.
loadproc	Number of loads processing.
loadqtim	Specific load total queue time.
loadqtim	Specific load total queue time.
loadsize	Specific load size.
loadsize	Specific load size.
loadwait	Number of loads waiting.
loadwait	Number of loads waiting.
lognormal	

## Scheduling Shop Floor Activity

---

<b>Function</b>	<b>Description (blank description indicates function not supported)</b>
lookup	Get a value from a setup matrix.
lookup	Get a value from a setup matrix.
matcap	
matcap	Material capacity.
matlevl	
matlevl	Current material level.
maveaqln	
maveaqln	
maveaqtm	
maveaqtm	
maverqln	
maverqln	
maverqtm	
maverqtm	
mcavqlen	
mcavqlen	
mcavqtim	
mcavqtim	
mcblock	
mcblock	
mcbreak	
mcbreak	
mcbusy	
mcbusy	
mccrbck	
mccrbck	
mccrbreak	
mccrbreak	
mccrbusy	
mccrbusy	



Function	Description (blank description indicates function not supported)
mccridle	
mccrmaint	
mccrmaint	
mccroff	
mccroff	
mccrset	
mccrset	
mccurqln	
mcidle	
mcmaint	
mcoff	
mconblk	
mconbreak	
mconbusy	
mconidle	
mconmaint	
mconset	
mcrblkmb	
mcrblkmb	
mrcurshift	
mrcurshift	
mcrmem	
mcrmem	
mcrprct	
mcrprct	Estimated time to complete operation
mcrstat	
mcrstat	
mcsetup	
mcsetup	
mctmeos	

## Scheduling Shop Floor Activity

<b>Function</b>	<b>Description (blank description indicates function not supported)</b>
mctmeos	Time to end of up period.
mcuraqln	
mcuraqln	
mcurrqln	
mcurrqln	
mhname	Specific load material handling device name.
mhname	
mhtype	Specific load material handling type ('C', 'A', 'T', '0').
mhtype	
mtavail	
mtavail	
mtavelav	
mtavelev	
mtcurrem	Current number of units being removed.
mtcurship	
mtcurship	Current number of material units being shipped.
mtorigship	
mtorigship	Original number of material units to be shipped.
mttime	
mttime	Current time in material.
normal	
obsave	Observed statistic average value
obsave	Observed statistic average value
obsmax	Observed statistic maximum value
obsmax	Observed statistic maximum value
obsmin	Observed statistic minimum value
obsmin	Observed statistic minimum value
obsstd	Observed statistic standard deviation
obsstd	Observed statistic standard deviation

<b>Function</b>	<b>Description (blank description indicates function not supported)</b>
orddone	Number of jobs completed.
orddone	Number of jobs completed.
orddone	Specific load job name.
ordernam	Specific load job name.
partfam	Specific load part family name.
partfam	Specific load part family name.
partname	Specific load part name.
partname	Specific load part name.
partsfam	Specific load part subfamily name.
partsfam	Specific load part subfamily name.
paveqlen	
paveqlen	
paveqtim	
paveqtim	
pcurqlen	
pcurqlen	
plavail	
plavail	
poisson	
poolbusy	
poolbusy	
poolcap	
poolcap	
poolutil	
poolutil	
proctime	Specific load processing time.
proctime	Current load processing time.
prtdone	Number of parts completed.
prtdone	Number of parts completed.
prtinsys	Number of parts in the system.

<b>Function</b>	<b>Description (blank description indicates function not supported)</b>
prtinsys	Number of parts in the system.
prtproc	Number of parts processing in the system.
prtproc	Number of parts processing in the system.
prtwai	Number of parts waiting in the system.
prtwait	Number of parts waiting in the system.
random	
raveqlen	Average queue length for a resource.
raveqlen	Average queue length for a resource.
raveqtim	Average waiting time for a resource.
raveqtim	Average waiting time for a resource.
rcurqlen	Current queue length for a resource.
rcurqlen	Current queue length for a resource.
remproc	Specific load remaining processing time.
remproc	Current load remaining processing time.
resstat	Current resource status.
resstat	Current resource status.
rgavqlen	Average queue length for a resource group.
rgavqlen	Average queue length for a resource group.
rgavqtim	Average waiting time for a resource group.
rgavqtim	Average waiting time for a resource group.
rgbblock	Current number of blocked resources in a resource group.
rgbblock	Current number of blocked resources in a resource group.
rgbbreak	Current number of resources in breakdown in a resource group.
rgbbreak	Current number of resources in breakdown in a resource group.
rgbbusy	Current number of busy resources in a resource group.
rgbbusy	Current number of busy resources in a resource group.

<b>Function</b>	<b>Description (blank description indicates function not supported)</b>
rgcrblk	Current resource group blocked time proportion.
rgcrblk	Current resource group blocked time proportion.
rgcrbreak	Current resource group breakdown time proportion.
rgcrbreak	Current resource group in breakdown time proportion.
rgcrbusy	Current resource group busy time proportion.
rgcrbusy	Current resource group busy time proportion.
rgcridle	Current resource group idle time proportion.
rgcridle	Current resource group idle time proportion.
rgcrmaint	Current resource group maintenance time proportion.
rgcrmaint	Current resource group maintenance time proportion.
rgcroff	Current resource group off-shift time proportion.
rgcroff	Current resource group off-shift time proportion.
rgcrset	Current resource group setup time proportion.
rgcrset	Current resource group setup time proportion.
rgcurqln	Current queue length for a resource group.
rgcurqln	Current queue length for a resource group.
rgidle	Current number of idle resources in a resource group.
rgidle	Current number of idle resources in a resource group.
rgindex	Specific load index of member from resource group allocated to load.
rgmaint	Current number of resources in maintenance in a resource group.
rgmaint	Current number of resource in maintenance in a resource group.
rgmem	Specific load name of resource from group allocated to load.
rgmem	Specific load name of resource from group allocated to load.

## Scheduling Shop Floor Activity

<b>Function</b>	<b>Description (blank description indicates function not supported)</b>
rgoff	Current number of off-shift resources in a resource group.
rgoff	Current number of off-shift resources in a resource group.
rgonblk	Current resource group on-shift blocked time proportion.
rgonblk	Current resource group on-shift blocked time proportion.
rgonbreak	Current resource group on-shift breakdown time proportion.
rgonbreak	Current resource group on-shift breakdown time proportion.
rgonbusy	Current resource group on-shift busy time proportion.
rgonbusy	Current resource group on-shift busy time proportion.
rgonidle	Current resource group on-shift idle time proportion.
rgonidle	Current resource group on-shift idle time proportion.
rgonmaint	Current resource group on-shift maintenance time proportion.
rgonmaint	Current resource group on-shift maintenance time proportion.
rgonset	Current resource group on-shift setup time proportion.
rgonset	Current resource group on-shift setup time proportion.
rgsetup	Current number of setup resources in a resource group.
rgsetup	Current number of setup resources in a resource group.
rsblkmb	Resource block time at move and move-between operations
rsblkmb	Resource block time at move and move-between operations
rscrblk	Current resource blocked time proportion.

<b>Function</b>	<b>Description (blank description indicates function not supported)</b>
rscrblck	Current resource blocked time proportion.
rscrbreak	Current resource breakdown time proportion.
rscrbreak	Current resource breakdown time proportion.
rscrbusy	Current resource busy time proportion.
rscrbusy	Current resource busy time proportion.
rscreset	Current resource setup time proportion.
rscridle	Current resource idle time proportion.
rscridle	Current resource idle time proportion.
rscrmaint	Current resource maintenance time proportion.
rscrmaint	Current resource maintenance time proportion.
rscroff	Current resource off-shift time proportion.
rscroff	Current resource off-shift time proportion.
rscrset	Current resource setup time proportion.
rscurshift	Resource current shift.
rscurshift	Resource current shift.
rsonblck	Current resource on-shift blocked time proportion.
rsonblck	Current resource on-shift blocked time proportion.
rsonbreak	Current resource on-shift breakdown time proportion.
rsonbreak	Current resource on-shift breakdown time proportion.
rsonbusy	Current resource on-shift busy time proportion.
rsonbusy	Current resource on-shift busy time proportion.
rsonidle	Current resource on-shift idle time proportion.
rsonidle	Current resource on-shift idle time proportion.
rsonmaint	Current resource on-shift maintenance time proportion.
rsonmaint	Current resource on-shift maintenance time proportion.
rsonset	Current resource on-shift setup time proportion.
rsonset	Current resource on-shift setup time proportion.
rsprct	Estimated time to complete current operation.

## Scheduling Shop Floor Activity

---

<b>Function</b>	<b>Description (blank description indicates function not supported)</b>
rsprct	Estimated time to complete current operation.
rstmeos	Time to end of "up" period.
rstmeos	Time to end of "up" period.
seaamb	
sears	Returns resource availability status to a load. (Considers must-complete and maximum-overrun.)
seacsq	Turn on the sequencing rule for a request list.
seadmb	
seadmt	
seadov	
seadsl	Add a resource to selection list.
seagsl	
seajld	Adjust the accumulators and resource counts for a load.
seakmt	
sealmb	
sealmc	
sealpl	
sealrg	Allocate a resource from a resource group to a load.
sealrs	Allocate a resource to a load.
seaqmt	
seaqor	
seavmb	
seavmt	
seavpl	
seavrs	Returns resource availability status. (Does not consider must-complete and maximum-overrun.)
seckmb	
seckpl	
seckrs	Checks the queue for a resource.
secmds	Compute dynamic slack for a load.



Function	Description (blank description indicates function not supported)
secqmc	
secqor	
secqpl	
secqrg	Cancel a request for a resource group to a load.
secqrs	Cancel a request for a resource to a load.
secrcl	Create resource capacity list for a load.
secrwcl	Create WIP capacity list for a load.
secsmb	
secsrs	Change resource state.
secvsl	
sedfag	
sedfag	
sedfal	
sedfal	
sedfbq	
sedfbq	
sedfbs	
sedfbs	
sedfcv	
sedfcv	
sedfgs	Install a resource group member selection function.
sedfgs	Install a resource group member selection function.
sedfjs	Install an operation event processing function.
sedfjs	Install an operation event processing function.
sedfmq	
sedfmq	
sedfms	
sedfms	
sedfok	Install a job ranking function.
sedfov	

## Scheduling Shop Floor Activity

---

<b>Function</b>	<b>Description (blank description indicates function not supported)</b>
sedfov	
sedfpl	
sedfpl	
sedfpu	
sedfrk	Install a load ranking function.
sedfrk	Install a load ranking function.
sedfrl	
sedfrl	
sedfsl	Install a resource request selection function.
sedfsl	Install a resource request selection function.
sedftr	
sedftr	
seepor	End processing for a job.
sefdac	
sefdac	
sefdaf	
sefdaf	
sefdag	
sefdag	
sefdas	
sefdas	
sefdat	
sefdat	
sefdbt	
sefdbt	
sefdcc	
sefdcc	
sefdcg	
sefdcg	
sefdcpg	

<b>Function</b>	<b>Description (blank description indicates function not supported)</b>
sefdcs	
sefdcs	
sefddmnd	Find a demand definition.
sefdfb	
sefdfb	Find a forming batch load.
sefdil	Find an in-process load.
sefdil	Find an in-process load.
sefdjs	Find an operation.
sefdjs	Find operation.
sefdlk	Find a setup matrix.
sefdmcm	
sefdmcm	
sefdmcr	
sefdmcr	
sefdmcrq	
sefdmcrq	
sefdmq	
sefdmq	
sefdmt	
sefdmt	
sefdor	Find a job.
sefdpl	
sefdpl	
sefdpq	
sefdpq	
sefdpr	Find a routing.
sefdpt	Find a part.
sefdpull	
sefdrg	Find a resource group.
sefdrg	Find a resource group.

## Scheduling Shop Floor Activity

---

<b>Function</b>	<b>Description (blank description indicates function not supported)</b>
sefdrq	Find a request matching a given load in a given list.
sefdrq	Find a request matching a given load in a given list
sefdrs	Find a resource.
sefdrs	Find a resource.
sefdrt	Find a resource tag matching a given resource in a given list.
sefdrt	
sefdrt	Find a resource tag matching a given resource in a given list.
sefdry	Find a resource type.
sefdry	
sefdry	Find a resource type.
sefdsh	Find a shift schedule.
sefdtc	
sefdtc	
sefdtf	
sefdtf	
sefdtg	
sefdtg	
sefdts	
sefdts	
sefdvr	
sefdvr	
seferr	Report a fatal error message.
sefmmc	
sefmrg	Free list of members to allocate.
sefrmb	
sefrmc	
sefrpl	

Function	Description (blank description indicates function not supported)
sefrg	Free a number of units of a resource group for a load.
sefrs	Free a resource from a load.
seinjs	General interrupt of an operation event function.
seissd	
seissd	
seissd	Return whether shift is down.
seissd	Determines whether a resource is off shift.
seissd	
sejsev	Schedules a load to arrive at an operation.
sejssl	Determine whether to process this operation.
selork	Return the ranking of a load.
semasl	
semcmp	Check a load for exceeding the maximum overrun for a resource or MCR.
semcms	
semcql	
semcrqor	
semkfb	
semqor	
semrsl	
semvbt	
semvld	Move some or all of the possessions of a load to another load.
senwld	Create a load.
sepqor	
sepqsl	
seprct	
seprct	Returns the projected completion time of a job.
sepurl	
sequfb	

## Scheduling Shop Floor Activity

<b>Function</b>	<b>Description (blank description indicates function not supported)</b>
sergms	Select a member from a resource group for a load (called from a member selection rule).
serkmt	
serlfb	
serlld	Release loads for a job.
sermmb	
sermmt	
sermot	Compute the number of remaining operations and processing time for a load.
sermsl	Remove a resource from selection list.
serqmc	
serqmt	
serqor	Returns relationship of resource requests.
serqpl	
serqrg	Request a number of units of a resource group for a load.
serqrs	Request a resource for a load.
serqsl	Reorders the resource request list before a request is selected.
ses2di	Convert a simulation time into date and time integers.
ses2ds	Convert a simulation time into a "MM-DD-YY HH:MM" form.
ses2st	Convert a simulation time into a "MM-DD-YY HH:MM:SS" form.
seslfb	
seslmc	
seslrg	Select a member from a resource group for a load (called from an allocation rule).
setmld	Terminate a load.
setosq	Turn off the sequencing rule for a request list.
setqor	
setrace	Report a debug trace message.

<b>Function</b>	<b>Description (blank description indicates function not supported)</b>
setrev	Event function to change the trace level.
setrlv	Change the trace level.
setrsl	
setseed	Set the initial random number seed for a stream of pseudo-random numbers.
seutmb	
seutrs	Return resource utilization.
sewarn	Report non-fatal warning.
sexfrl	Transfer a list of resources to a load.
sexfrs	Transfer a specific resource to a load.
siaash	
siacsh	
siadhr	
siadhr	Add a held resource to an in-process load.
siadrf	
siadrf	
siadrf	Add a resource reference to an operation.
siadrf	Add a resource group reference to an operation.
siamsh	
siarsh	Add a shift reference to a resource.
siatsh	
sichange	Mark a component as changed.
sierr	Report fatal input error.
simend	Ending simulation time (hours from start).
simend	Ending simulation time (hours from start).
simnow	Current simulation time (hours from start).
simnow	Current simulation time (hours from start).
siorrk	Return the ranking of a job.
sistsv	Allocate storage for and copy a string.
siwarn	Report non-fatal input warning.

## Scheduling Shop Floor Activity

---

<b>Function</b>	<b>Description (blank description indicates function not supported)</b>
statsclr	Time statistics were last cleared (hours from start).
statsclr	Time statistics were last cleared (hours from start).
stcharat	
stcharvr	
sticslist	Retrieve a CSLIST from a status file.
stintat	
stintvr	
stipointer	Retrieve a buffer from a status file.
stocslst	Save a CSLIST to a status file.
stopointer	Save a buffer to a status file.
strealat	
strealvr	
taveqlen	Average queue length for a transporter fleet.
taveqlen	
taveqtim	Average load waiting time for a transporter fleet.
taveqtim	
tcurqlen	Current queue length for a transporter fleet.
tcurqlen	
tpvave	
tpvave	
tpvmax	
tpvmax	
tpvmin	
tpvmin	
tpvstd	
tpvstd	
tranblk	
tranblk	
tranbreak	
tranbreak	



<b>Function</b>	<b>Description (blank description indicates function not supported)</b>
tranbusy	
tranbusy	
trancap	
trancap	
tranidle	
tranidle	
tranmaint	
tranmaint	
tranoff	
tranoff	
trchgst	
trcrblck	
trcrblck	
trcrbreak	
trcrbreak	
trcrbusy	
trcrbusy	
trcridle	
trcridle	
trcrmaint	
trcrmaint	
trcroff	
trcroff	
trcurshift	
trcurshift	
trdfvs	
trdfvs	
trdist	
triangular	
tronblck	

Function	Description (blank description indicates function not supported)
tronblck	
tronbreak	
tronbreak	
tronbusy	
tronbusy	
tronidle	
tronidle	
tronmaint	
tronmaint	
trrqchk	
trrtdf	
trrtdf	
trrtsl	
trrtsl	
trtmeos	
trtmeos	
trvsr	
trvsr	
uccschd0	Schedule a user event on the internal event calendar.
uccsched	Schedule a user event on the regular event calendar.
uniform	
weibull	

## Writing Custom Job Release Rules

**Note:** See "Writing a Custom Scheduler Rule" on page 130 for a summary of the steps required to create custom rules. For more details about the functions described in this topic, see the *Scheduling Customization Guide*, available for download from the Support web site.

Job release rules on the Shop Floor Control Parameters form determine the sequence of scheduling for jobs with the same release date and time.

## Naming the Function

Your custom function can have any name that is not a standard user-callable function name.

## Arguments

### Summary

```
#include "factor.h"
double myrule(op)
ORDER *op; /* pointer to the job. */
```

This function must accept a job (Type: ORDER\*) as its only argument.

### Return Value

The function should return the ranking value of the job (Type: double).

```
double orrl (ORDER *op)
/*-----
   Ranking function to cause new jobs to be ranked on a high-to-low
   priority.
   ARGS:
       op - pointer to job for which to evaluate ranking rule
   RETURNS: job-ranking value
   -----*/
{
    return((double) -op->orprio);
}
```

## Installing the Custom Function

To make your custom job release function available to the Scheduler, you must "install" it from the initialization function ucini1 by calling the function sedfok. The function sedfok has two arguments:

- 1 The number of the job release rule for which your release function contains custom logic.
- 2 The address of your job release function.

For example, to install the above example rule "orrl" in rule position 39:

```
sedfok (39, orrl);
```

## Writing Custom Resource Allocation Rules

**Note:** See "Writing a Custom Scheduler Rule" on page 130 for a summary of the steps required to create custom rules. For more details about the functions described in this topic, see the *Scheduling Customization Guide*, available for download from our Support site.

Resource allocation rules are used to decide which resources from a resource group the Scheduler will use when it allocates resources to a load. They are also used for reallocating resources if reallocation has been enabled for the group.

### Naming the Function

The function can have any name that is not a standard user-callable function name.

### Arguments

```
#include "factor.h"
void myrule(gp, nu, ldp, mlist)
RESGRP    *gp;    /* pointer to resource group. */
int        nu;    /* number of units required. */
LOAD      *ldp;   /* pointer to the load. */
CSLIST    *mlist; /* current selection list. */
```

The function must accept four arguments in the following order:

- 1 A pointer to the resource group (Type: RESGRP\*).
- 2 An integer for the number of resources to be selected from that group for allocation (Type: int).
- 3 A pointer to the load requesting to allocate from the resource group (Type: LOAD\*).
- 4 A list to be populated with RMTAGS of resources selected for allocation from the group (Type: CSLIST\*).

### Adding and Removing Group Members

Group members can be added and removed from the list of selected resources (mlist) using the system support functions seadsl and sermsl, respectively. To add group members to the list, use function seadsl as follows:

```
void seadsl(CSLIST *mlist, RESMEMB *rmp)
```

To remove group members from the list, use function sermsl as follows:

```
void sermsl(CSLIST *mlist, RMTAG *rmt)
```

## Return Values

The function should return nothing (Type: void).

Here is an example of a rule to select available resource group members on the basis of least mean utilization:

```
void rgsr (RESGRP *gp, int nu, LOAD *ldp, CSLIST *mlist)
/*-----
Function to process resource group selection code 3, select
required number of member resources that have the least mean
utilizations (as a fraction of capacity).
NOTES:
* Ties are broken by selecting the first in the order listed
in the group.
* This function requires that resource statistics be enabled.
Any resource which does not have statistics enabled is
assumed to have a utilization of zero. Thus if all
resource statistics are disabled, this defaults to
rule 0.
* This function uses seaars, which includes must complete and
maxOT in its considerations, to determine the availability
of each member resource.
ARGS:
gp      - pointer to resource group to select member from
nu      - number of units required from selected member
ldp     - pointer to load to which resource will be allocated
mlist  - list to hold selected RESMEMB's
RETURNS: void
-----*/
{
    int i, j, *avail;
    double min, *util;
    RESMEMB *minp, *rmp;
    /* Allocate arrays for availability and utilization. */
    avail = (int *) malloc(sizeof(int) * csszls(gp->rgrsls));
    if ( avail == NULL )
    {
        seferr(0, "Out of Memory");
    }
    util = (double *) malloc(sizeof(double) * csszls(gp->rgrsls));
    if ( util == NULL )
    {
        seferr(0, "Out of Memory");
    }
    /* Compute availability and utilization. */
    for ( rmp = (RESMEMB *) csfsls(gp->rgrsls), j = 0;
          rmp != NULL;
          rmp = (RESMEMB *) csnxls((CSENTITY *) rmp), j++ )
    {
        avail[j] = seaars(rmp->rmres, ldp);
        util[j] = seutrs(rmp->rmres);
    }
}
```

```

}
/* For the required number of units */
for ( i = csszls(mlist); i &LT nu; i++ )
{
    /* For each resource which is available. */
    minp = NULL;
    for ( rmp = (RESMEMB *) csfsls(gp->rgrsls), j = 0;
          rmp != NULL;
          rmp = (RESMEMB *) csnxls((CSENTITY *) rmp), j++ )
    {
        if ( (! rmp->rmres->rssselfg) && (avail[j] > 0) )
        {
            /* Save if min. */
            if ( (minp == NULL) || (util[j] &LT min) )
            {
                minp = rmp;
                min = util[j];
            }
        }
    }
    if ( minp == NULL )
    {
        break;
    }
    seadsl(mlist, minp);
}
free(avail);
free(util);
return;
}

```

### Installing the Custom Function

To make your custom resource allocation function available to the Scheduler, you must "install" it from the ucini1 function by calling the function sedfgs. The function sedfgs has two arguments in the following order:

- The number of the resource allocation rule for which your function contains custom logic.
- The address of your resource allocation function.

For example, to install the above example rule "rgsr" in rule position 39:

```
sedfgs (39, rgsr);
```

## Writing Custom Selection Rules

**Note:** See "Writing a Custom Scheduler Rule" on page 130 for a summary of the steps required to create custom rules. For more details about the functions described in this topic, see the *Scheduling Customization Guide*, available for download from our Support site.

The Scheduler uses selection rules to sequence the request queue when it removes requests from the queue (when a resource becomes available).

### Selection Rule Logic

Before you create custom selection rules and write the corresponding selection functions, you should understand the logic used by the selection function. When a resource becomes available, the selection function is called. The request queues are contained in internal lists owned by the respective resource that is initially sequenced by the sequencing rule.

When the selection function is called, it reorders this list and returns the maximum number of requests to be considered in the allocation process. If the whole list is sorted, it returns the size of the list. Thus, if the number of requests returned is less than the size of the list, the sorted list for allocation may be only part of the queue of requests.

The allocation process begins by attempting to restart the operation for the first request on the sorted list for allocation that requires the number of available units or fewer. If the allocation process fails, the next request on the sorted list for the number of available units or fewer is considered. Successive requests on the sorted list for allocation are considered until the available units have been allocated or the end of the sorted list for allocation is reached. If there are available units after the last request is considered, they remain idle.

### Naming the Function

Your custom selection function can have any name that is not a standard user-callable function name.

### Arguments

```
#include "factor.h"
int myrule(rp)
RESRC *rp; /* pointer to the resource */
```

The selection function accepts as its only argument a pointer to the component you are performing the selection for, which is a resource (Type: RESRC \*).

### Return Value

The function returns a value (Type: int) which is the maximum number of requests to be processed.

Here is an example of a resource selection function based on minimum setup:

```

int srl1 (RESRC *rp)
/*-----
   Selection function to process a resource request list by using
   the minimum setup time for this resource on the first downstream
   setup operation for each load.  Loads that have no downstream
   setup operation are assumed to have a setup time of zero.
   NOTES:
   * The estimate flag is set to false for jscmsu so that it will
   use the current conditions to find the setup time.  Since the
   operation could be downstream, there is no guarantee that the
   current conditions for the resource in question will still
   be appropriate when the setup actually occurs.  Therefore,
   this rule should only be used when the structure of the model
   guarantees that the conditions for the downstream resource
   will be constant till the setup occurs.
   ARGS:
   rp - pointer to resource to resequence
   RETURNS: number of requests in the request list
   -----*/
{
  RREQ *rq;
  JOBSTEP *jsp;
  int i;
  for ( rq = (RREQ *) csfsls(rp->rsrqls);
        rq != NULL;
        rq = (RREQ *) csnxls((CSENTITY *) rq) )
  {
    /* Find first downstream setup operation.  */
    for ( jsp = rq->rrload->lojspt, i = 0;
          jsp != NULL && jsp->jstype != 4 &&
          jsp->jstype != 13 && jsp->jstype != 19 && i < 1000;
          jsp = jsp->jspnxt, i++);
    /* Compute setup time (zero if no setup operation).  */
    if (jsp == NULL || i >= 1000)
    {
      rq->rrprio = 0.0;
    }
    else
    {
      /* Place a tag for the resource.  This allows the step
         time to be computed properly for the downstream
         operation assuming that the load allocates the
         resource before any other load.  */
      dumrtag->rtrsrc = rp;
      cspols(rq->rrload->lorsls, (CSENTITY *) dumrtag, CSLIFO,
NULL);
      rq->rrprio = jscmsu(0, rq->rrload, jsp);
      csgpls(rq->rrload->lorsls, (CSENTITY *) dumrtag);
    }
  }
}

```



```

    }
}
/*Sort list based on rankings.*/
cssols (rp->rsrqls, serqor);
/*return number in list*/
return (csszls(rp->rsrqls));
}

```

## Installing the Custom Function

To make your custom resource selection function available to the Scheduler, you must "install" it from ucini1 by calling the function sedfsl. This function has two arguments in the following order:

- The number of the selection rule for which your selection function contains custom logic.
- The address of your selection function.

For example, to install the above example rule "slrl" in rule position 39:

```
sedfsl (39, slrl);
```

If you use one of the provided "dynamic" selection rules, the system will ignore the sequencing rule and use first-in-first-out (FIFO). If you write a dynamic selection rule, you should also emulate the system and force the use of FIFO. To do this, invoke function setosq on the applicable request list.

## Writing Custom Sequence Rules

**Note:** See "Writing a Custom Scheduler Rule" on page 130 for a summary of the steps required to create custom rules. For more details about the functions described in this topic, see the *Scheduling Customization Guide*, available for download from our Support site.

To rank request queues, the logic of each sequencing rule is written into a load-ranking function. You can write and install tailored load ranking functions to sequence queues by rules that are specific to your manufacturing operation.

### Sequence Rule Logic

Before creating your own load-ranking functions, you should understand how requests are processed by the sequence rule. When a load places a request, the load-ranking function gives the request a ranking value. The ranking value never changes.

For example, suppose a sequencing rule ranks requests based on the time remaining until due date. At 1 p.m. today a load with a due date at 4 p.m. today places a request and is given a ranking value of 3. At 3 p.m. today, a load with due date at 5 p.m. today places a request and receives a ranking value of 2. Assume that these are the only requests in the queue. Suppose that one of these requests is satisfied at 3:30. The request that is satisfied is the one with ranking value of 2, even though it has 1.5 hours until it is due and the request with ranking value 3 has only 0.5 hour until it is due.

Requests are ranked in the internal list representing the queue from low to high based on the ranking value. You can reverse this order in your custom logic by multiplying the ranking value by -1. For example, to rank loads based on a longest processing time for a current operation, a ranking function would return the negative of the processing time for the load at its current operation.

### Naming the Function

Your custom load-ranking function can have any name that is not a standard user-callable function name.

### Arguments

```
#include "factor.h"
double myrule(ldp, atrib)
LOAD      *ldp; /* pointer to the load. */
ATTRIBUTE *atr; /* pointer to attribute, if any, to base ranking on.
*/
```

The function must accept two arguments in the following order:

- A load (Type: LOAD\*).
- An attribute (Type: ATTRIBUTE).

### Return Value

The function must return a value (Type: double) which is the ranking value of the load's request.

Here is an example of a load-ranking function to order loads based on least dynamic slack (that is, the least remaining time to due date minus the remaining processing time):

```
double sql (LOAD *ldp, ATTRIBUTE *atr)
/*-----
Ranking function to cause loads to be ranked on a least dynamic
slack basis.
  ARGS:
    ldp - pointer to load for which to evaluate the ranking code
  RETURNS: load ranking value
-----*/
{
  double rt, lt;
  int rn;
  rt = sermot(ldp, &rn, <);
  return(ldp->loordp->ordudt - DATENOW - rt);
}
```

## Installing the Custom Function

To make your custom function available to the Scheduler, you must "install" it from the initialization function `ucini1` by calling the function `sedfrk`. `Sedfrk` has two arguments in the following order:

- The number of the sequencing rule for which your ranking function contains custom logic.
- The address of your load-ranking function.

For example, to install the above example rule "sql" in rule position 39:

```
sedfrk (39, sql);
```

## Writing Custom Setup Rules

**Note:** See "Writing a Custom Scheduler Rule" on page 130 for a summary of the steps required to create custom rules. For more details about the functions described in this topic, see the *Scheduling Customization Guide*, available for download from our Support site.

To determine whether a setup is necessary, you can write a function, `ucwtsr`, that the Scheduler uses when the Setup Rule on an operation is set to a user-defined setup rule (rule positions 3-39).

## Naming the Function

Your custom function can have any name that is not a standard user-callable function name.

## Arguments

### Summary

```
#include "factor.h"
int ucwtsr (ldp, type, rp, jsp, rule)
LOAD      *ldp; /* pointer to the load. */
TCHAR    type; /* 'R' (resource) */
void      *rp; /* pointer to the resource to setup. */
JOBSTEP  *jsp; /* pointer to the operation. */
int       rule; /* setup rule to use. */
```

Function `ucwtsr` must accept five arguments in the following order:

- 1 A pointer to a load (Type: LOAD\*).
- 2 Type of resource ("R"esource) (Type: char).
- 3 A pointer to a resource (Type: void\*).
- 4 A pointer to an operation (Type: JOBSTEP\*).
- 5 Setup rule (Type: int).

## Return Values

The function should return 1 for success (setup should be done) and 0 for failure (setup should not be done). Type: int.

The following example of ucwtsr sets up a resource every time the part and/or operation changes for the resources.

```
int ucwtsr(LOAD *ldp, TCHAR type, void *rp, JOBSTEP *jsp, int rule)
/*-----
Function to set up a resource if the item or operation is
different from last setup
ARGS:
    ldp - pointer to load
    type - "R"esource
    rp - pointer to resource
    jsp - pointer to operation
    rule - Setup rule
RETURNS
    true - perform setup, or
    false - do not perform setup
-----*/
{
    int ireturn = 0;
    char error[400];
    /* Check if setup or setup/operate or super operation. */
    if ( (jsp->jstype != 4) && (jsp->jstype != 13) )&&
        (jsp->jstype != 19) )
    {
        Super
        sprintf(error, "Operation not a Setup or Setup/Operate or
            operation\n\nOrder ID %s\nLoad ID %d\nBatch ID
            %ld\nOperation ID %s\nOperation Type %d\n",
            ldp->loordp->orid, ldp->loid, (ldp->lobat == NULL)
            ? OL : ldp->lobat->bibatid, jsp->jsid, jsp->jstype);
        seferr(0, error);
    }
    if (type == 'R')
    {
        ireturn = (((RESRC *)rp)->rsptst != ldp->loordp->orptpt
            || ((RESRC *)rp)->rsjsst != jsp) ? 1 : 0;
    }
    else
    {
        ireturn = (((MCRMEMBER *)rp)->mbrptst != ldp->loordp->orptpt
            || ((MCRMEMBER *)rp)->mbrjsst != jsp) ? 1 : 0;
    }
    return (ireturn);
}
```

## Installing the Custom Function

It is not necessary to install ucwtsr in ucini1 because it is called automatically when the setup rule is greater than 2 (that is, a non-standard rule number).

## Writing Custom Batch Separation Rules

**Note:** See "Writing a Custom Scheduler Rule" on page 130 for a summary of the steps required to create custom rules. For more details about the functions described in this topic, see the *Scheduling Customization Guide*, available for download from our Support site.

The Scheduler uses separation rules to define how arriving jobs are to be separated into batches.

### Batch Separation Rule Logic

Before you create custom batch separation rules and write the corresponding batch separation functions, you should understand the logic used by the batch separation function. When a job arrives at an operation with a batch definition specified, the batch separation function is called.

When the batch separation function is called, it determines which forming batch the arriving job should be placed into based on some characteristic such as item number, color, etc. If there are other jobs waiting to be processed by the batch, the arriving job can be combined with them; otherwise it creates a new forming batch.

### Naming the Function

Your custom batch separation function can have any name that is not a standard user-callable function name.

### Arguments

```
#include "factor.h"
FORMBAT *bsrl(ldp, batch)
LOAD *ldp; /* pointer to the load */
BATCHDEF *batch; /* pointer to the batch definition */
```

The function accepts two arguments, a pointer to load (Type: LOAD \*) and a pointer to the batch (Type: BATCHDEF \*).

### Return Value

The function returns a pointer to the forming batch that this job should be added into, or NULL if it starts a new forming batch (Type: FORMBAT \*).

Here is an example of a batch separation function based on item:

```
FORMBAT *bsrl (LOAD *ldp, BATCHDEF *batch)
/*-----
  Batch separation rule which separates arriving jobs into
  different batches based on the item number.
  ARGS:
    ldp - pointer to the arriving load (job)
    batch - pointer to the batch that this load will follow
  RETURNS: pointer to the forming batch
-----*/
{
  FORMBAT *fb;
  for ( fb = (FORMBAT *) csfsls(batch->btfmls);
        fb != NULL;
        fb = (FORMBAT *) csnxls((CSENTITY *) fb) )
  {
    /* Return this forming batch if its children have the same
       part as the load passed in, and the new quantity will be
       less than or equal to the maximum. */
    if ((strcmp(fb->fbldp->loordp->orptpt->panum,
               ldp->loordp->orptpt->panum) == 0) &&
        (fb->fbquant + sequfb(ldp, batch, batch->btqurl)
         < _batch->"batch-">btmax))
    {
      Return(fb);
    }
  }
  /* return NULL if we couldn't find one */
  Return(NULL);
}
</_>
```

### Installing the Custom Function

To make your custom separation function available to the Scheduler, you must "install" it from ucini1 by calling the function sedfsb. This function has two arguments in the following order:

- The number of the batch separation rule for which your function contains custom logic.
- The address of your batch separation function.

For example, to install the above example rule "bsrl" in rule position 39:

```
sedfsb (39, bsrl);
```

## Writing Custom Batch Release Rules

**Note:** See "Writing a Custom Scheduler Rule" on page 130 for a summary of the steps required to create custom rules. For more details about the functions described in this topic, see the *Scheduling Customization Guide*, available for download from our Support site.

The Scheduler uses batch release rules to define the quantity that arriving jobs add to batches that are forming. This rule is sometimes also referred to as a batch quantity rule.

### Batch Release Rule Logic

Before you create custom batch release rules and write the corresponding batch release functions, you should understand the logic used by the batch release function. When a job arrives at an operation with a batch definition specified, the batch release function is called.

When the batch release function is called, it determines what quantity is added to the forming batch, which in turn determines when the forming batch will be released.

### Naming the Function

Your custom batch release function can have any name that is not a standard user-callable function name.

### Arguments

```
#include "factor.h"
double brrl(ldp, batch)
LOAD *ldp;          /* pointer to the load */
BATCHDEF *batch;   /* pointer to the batch definition */
```

The function accepts two arguments, a pointer to load (Type: LOAD \*) and a pointer to the batch (Type: BATCHDEF \*).

### Return Value

The function returns a value to be added to the forming batch (Type: double).

Here is an example of a batch release function based on quantity in job:

```
double brrl (LOAD *ldp, BATCHDEF *batch)
/*-----
   Batch release rule which adds the quantity on the job.
   ARGS:
       ldp - pointer to the arriving load (job)
       batch - pointer to the batch that this load will follow
   RETURNS: job quantity
   -----*/
```

```
{  
  
    return((double)ldp->losize);  
  
}
```

### Installing the Custom Function

To make your custom release function available to the Scheduler, you must "install" it from ucini1 by calling the function `sedfbq`. This function has two arguments in the following order:

- The number of the batch release rule for which your function contains custom logic.
- The address of your batch release function.

For example, to install the above example rule "brrl" in rule position 39:

```
sedfbq (39, brrl);
```

## Writing Custom Batch Override Rules

**Note:** See "Writing a Custom Scheduler Rule" on page 130 for a summary of the steps required to create custom rules. For more details about the functions described in this topic, see the *Scheduling Customization Guide*, available for download from our Support site.

The Scheduler uses override rules on the Batch Definitions form to determine if forming batches should be released even though they have not reached the minimum release quantity.

### Override Rule Logic

Before you create custom batch override rules and write the corresponding batch override functions, you should understand the logic used by the override function. This rule is invoked under two conditions:

- When add override release reviews are enabled and a job is added to a forming batch, but the forming batch does not reach or exceed its minimum release quantity.
- During a periodic override release review, which occurs at an interval specified on the batch definition if the periodic review is enabled.

When the batch override function is called, it determines whether the forming batch should be released.

### Naming the Function

Your custom override function can have any name that is not a standard user-callable function name.



## Arguments

```
#include "factor.h"
int borl(formbat, batch)
FORMBAT *formbat;    /* pointer to the forming batch */
BATCHDEF *batch;     /* pointer to the batch definition */
```

The override function accepts two arguments, a pointer to forming batch (Type: FORMBAT \*) and a pointer to the batch (Type: BATCHDEF \*).

## Return Value

The function returns TRUE (non-zero) if the forming batch should be released or FALSE (zero) if the forming batch should not be released (Type:int).

Here is an example of a batch override function based on the time greater than or equal to the override threshold:

```
int borl (FORMBAT *formbat, BATCHDEF *batch)
/*-----
   Batch override rule which determines that the forming batch should
   be released if it has been waiting longer or equal to the override
   threshold.
   ARGS:
       formbat - pointer to the arriving forming batch
       batch - pointer to the batch that this load will follow
   RETURNS: true, if it has been waiting too long
           false, otherwise
   -----*/
{
    double x;
    x = cstnow - formbat->fbsttim;
    /* If the time the batch has been forming is at least the
       threshold, then release the batch */
    if (x >= batch->btovth)
    {
        return(1)
    }
    else
    {
        return(0)
    }
}
```

## Installing the Custom Function

To make your custom override function available to the Scheduler, you must "install" it from ucini1 by calling the function sedfok. This function has two arguments in the following order:

- The number of the batch override rule for which your function contains custom logic
- The address of your batch override function

For example, to install the above example rule "borl" in rule position 39:

```
sedfok (39, borl);
```

## Compiling and Linking Custom Scheduler Rules

To compile and link user code for the Scheduler, Microsoft Visual C++ Version 6.0 Service Pack 3 or later is required. If you did not install Microsoft Visual C++ with the option to set up for use from a command prompt, your PATH, LIB, and INCLUDE environment variables may not be set correctly. To set these variables, you can run VCVARS32.BAT, which is located in the \bin subdirectory of your Visual C++ installation.

See "Writing a Custom Scheduler Rule" on page 130 for a summary of the steps required to create custom rules.

To compile and link your custom Scheduler rules:

- 1 Create your database directory and copy the files MAKEFILE and USER.DEF from the \Program Files\Infor\Scheduler\USERCODE directory into it. For example:

```
$ cd USERCODE
$ mkdir mydb
$ cd mydb
$ copy ..\MAKEFILE
$ copy ..\USER.DEF
```

- 2 Edit the MAKEFILE and change the "OBJFILES" line, which is near the top of the file, to list your .C custom code files. Instead of a .C file extension, you must use a .OBJ file extension when specifying the files. For example, the files FILE1.C, FILE2.C, and FILE3.C would be specified as:  
OBJFILES = file1.obj file2.obj file3.obj

Case does not matter. In most cases, you will not need to change anything else in this file. However, there are additional variables you can use for custom compile or link options or for additional libraries to be linked into the program.

- 3 If your custom code calls functions uccschd0 or uccsched, you must perform this step. Otherwise, skip to step 4.

When scheduling custom events, you must add function declaration lines to the .DEF file that is used by the linker. For more details, see the *Scheduling Customization Guide*, available for download from our Support site. Instead of copying and editing the AIM\_SUSR.DEF file as documented there, you must make your edits to the USER.DEF file that you copied in step 1. Go to the end of the USER.DEF file and add a line consisting of the name of your custom event function. The case should match the case of the name as it appears in the .C file. Repeat this step for each custom event function.

- 4** You can now perform the compile and link by running the NMAKE command. At an MS-DOS command prompt, change directory to the database directory and run the NMAKE command. This command reads the file MAKEFILE and follows the directives in it to compile and link your user code. Be sure to correct any compile or link errors before proceeding. For example:

```
$ cd USERCODE\mydb
```

```
$ nmake
```

- 5** You can now run the Scheduler and it will use your custom code. Any time you change your custom code, you must repeat the appropriate steps in this process.



## About Shop Floor Transactions

Shop floor transaction reporting supports Period-Based costing and records transactions for production schedules and Just-In-Time (JIT) production. Scrap quantities are reported for production schedules. Material, labor, and machine transactions are recorded against work centers, not against specific items, as in Job costing. Transactions require minimal keying and do not require posting, as job transactions do.

## About Backflushing

While backflushing is an optional feature, it is tailored to minimize the number of entries you will need to enter to record transactions for jobs, production schedules, or JIT production. Based upon the routing of an item, backflushing automatically issues materials or record machine and labor hours, or any combination of materials and hours. You can use backflushing in conjunction with control points, which further automates your process.

To use backflushing, you must set up the backflushing location on the Inventory Parameters form.

**Note:** You cannot perform backflushing operations on items from consignment warehouse locations.

### Reverse Backflushing

Reverse backflushing costing uses the average Actual cost of materials. The system reverses labor and machine hours at the standard rate based on the routing. The manufacturing type determines the routing the system uses.

Manufacturing Type	Routing Used in Backflushing
Job	Job routing/BOM
Production Schedule	Production Schedule release routing/BOM
JIT Production	Current routing/BOM

### Lot-Tracked/Serial-Tracked Items

To backflush lot-tracked or serial-tracked items, you must first enable backflushing for these items on the Inventory Parameters form (**Control** tab) and the Items form (**Control** tab).

**Note:** Job material sequences can be changed or deleted even if there are pending lot-tracked or serial-tracked items that have not posted.

### Slow-Moving and Obsolete Items

Do not backflush items that are slow-moving or obsolete. If an item that is backflushed is later flagged as slow-moving or obsolete, remove it from all backflushing processes at that time.



**Caution:** You receive no warning or error messages if you backflush an item that is flagged as either Obsolete or Slow Moving.

### JIT Production

JIT production reports costs against a work center when that work center is defined as a control point in the current routing. The difference is that the system records Actual amounts for comparison against Earned amounts. The system accumulates variances by work center for the period you choose (for example, weekly).

**Note:** For both production schedules and JIT production, you can add manual transactions in addition to the transactions automatically recorded through backflushing.

### Vendor Consigned Inventory

If you have material in a vendor consignment warehouse when you perform a backflush, the system will check that warehouse for the required material. If found, it will transfer the necessary amount out of consignment, which will trigger a purchase order line with the vendor.

## Example: Backflushing

This example demonstrates the source of default of backflush locations for a job based on this setup:

Form (Part)	Field Settings
Inventory Parameters	<b>On Hand Neg Flag:</b> Selected
	<b>Backflush Location:</b> Floor
Items, <b>Controls</b> tab	<b>Backflush:</b> Selected
(AL-10000)	<b>Backflush Location:</b> Bin
Item Location/Work Center Floor Stock Location	<b>Work Center:</b> AS-500
	<b>Floor Stock Location:</b> A1

Form (Part)	Field Settings
Job Materials	<b>Backflush:</b> Selected
(AL-10000)	<b>Backflush Location:</b> Z3

Job 1293-0000 has operation 10 that goes through work center AS-500. If you add material AL-10000 to the job, the system would check the material level first and backflush from Z3. If there were no backflush location at this level, the system would proceed to the next level and backflush from A1 at the item location/work center level.

**Note:** The same hierarchy applies to both jobs and production schedules.

**Note:** If you will be using the Floor Stock Replenishment Report, it is better to leave the backflush location blank on the material level. Otherwise, you must set up the backflush location on the material level to be the same as the item location/work center level. In the above example, the backflush location on the material level would need to be A1 (instead of Z3), as well as at the item location/work center or floor stock location level.

If there were no item location/work center or floor stock level default, the system would check the Items - Controls level for a backflush location (in this case Bin) and backflush from there.

Finally, if there had been no default location specified at the Items form **Controls** tab level, the system would use the default value from the Inventory Parameters form and backflushed from the default, "Floor."

## About Backflushing and Control Points

### Control Points

Use of control points can greatly reduce the number of manual entries needed to report production. Control points on operations serve two purposes:

- To define which operations on a routing you will report production from.
- To manage backflushing through multiple operations. You can set each operation on a routing to be a control point and report production for each one, or you can set selected operations as control points and backflush the appropriate production quantities through the previous non-control point operations.

When a work center is created, you must specify whether it is a control point or not. This setting will be the default value for the routing operation when a work center is associated with the operation. It is possible to overwrite the default for each operation of a routing. Any and all operations within a routing can be specified as a control point.

### Control Point Processing

Backflushing is triggered automatically when you enter a quantity other than zero for quantity complete or scrapped for a posted transaction. If the operation is a control point, the system will look for preceding

operations to verify whether they are control points or not. If not, then the system assumes that the preceding non-control point operations associated with that control point will also have the same quantity complete value backflushed.

When you report a scrapped quantity for a control point, the same scrapped quantity is added to the quantity complete for all prior operations that are tied to that control point.

For a production scheduled item, if scrap is reported on a non-control point operation, the quantity complete is updated for all previously associated non-control point operations and those operations will be backflushed. For a job item, if scrap is reported on a non-control point operation, only the operation reported is backflushed.

### What Happens When a Control Point is Posted

Based on how you have set up your Inventory Parameters, Items form **Controls** tab, Operation, and Material forms for backflushing, the system will perform the following:

- Processes each operation controlled by the control point in turn, starting with the lowest operation number.
- Backflushes materials on the BOM for all operations controlled by the control point where the material has been set up to be backflushed.
- Backflushes labor and/or machine hours for all control points for operations where the **Backflush** field is set to **Labor**, **Machine**, or **Both**.
- Absorbs/backflushes overhead for all operations controlled by the control point based on the setting for overhead basis in the work center.
- Moves quantities to the next operation or to inventory (if it is the last operation), for all operations tied to the control point.
- Posts or receives into inventory all quantities (received, complete, scrapped and moved), when appropriate.
- Applies scrap factors applies to the material issues.

All calculations and posted amounts will be based on values from the routing. The routing that is used for backflushing is dependent upon the manufacturing type.

<b>Manufacturing Type</b>	<b>Routing Used in Backflushing</b>
Job	Job Routing
Production Schedule	Production Schedule Routing
JIT Production	Current Routing

No employee-specific labor will be posted except on the control point operation itself, where the posting originated. The transaction for the control point operation will be posted using employee rates and hours based on the appropriate routing.

### Reverse Backflushing

Reverse backflushing occurs when you key production transactions with a negative quantity complete amount. Materials issued to the job are moved back to inventory and labor and/or machine hours, overhead, and WIP will all be decreased.



Negative completed quantities may be manually entered for individual operations, or you may enter a negative completed quantity for an operation that is flagged as a control point.

When all production is reversed, so that the quantity complete is zero, setup hours will also be reversed.

## About Backflushing Labor and Machine Hours

To backflush labor hours and machine hours, you must set the **Backflush** field appropriately on the Operations form. The default value displays from the work center used in the operation, but you can overwrite it for each operation for the current routing, job routing, and production schedule routing. You can specify backflushing of labor hours, machine hours, both, or neither, by operation.

The system backflushes labor and machine hours based on 100% of the routing. The system does not consider manual entries of labor or machine hours for the current transaction.

### Backflushing Labor Hours

When you post completed transactions, the system backflushes labor hours if the **Backflush** field for the operation is set to "Labor" or "Both."

Backflushing occurs automatically when you post quantities for completed transactions or report scrap. The number of labor hours backflushed is based on the quantity complete or scrapped quantities multiplied by the labor hours per piece (defined on the routing). The system does NOT consider labor hours that have been previously backflushed or manually issued.

The manufacturing type determines the routing the system uses for backflushing, as indicated by the following chart:

Manufacturing Type	Routing Used in Backflushing
Job	Job Routing
Production Schedule	Production Schedule Routing
JIT Production	Current Routing

**EXAMPLE:** In this example, Item XYZ has been set up to backflush labor hours. Job 100 for Item XYZ requires 15 minutes or .25/hr labor hours for each completed unit. You manually enter one hour of labor.

Later you enter a transaction for five complete units. The backflushing process automatically issues 1.25 labor hours (.25/hr x five completed units). This is in addition to the one hour that was previously manually entered, for a total of 2.25 labor hours.

On the Job Operations form, you update the Total Setup Hrs field for the operation by a manual job transaction or as a result of backflushing setup through jobs, production schedules, or JIT complete transactions. The system increases the Total Setup Cost field by the planned setup hours, multiplied by the setup rate from the operation's work center record.

The system creates material transactions and inventory journal transactions with costs from the work center record. The system creates a run job transaction or production schedule transaction each time labor is backflushed.

The following fields are updated on the Job Operations form:

- Total Run Hours
- Total Run Cost
- Total Fixed Ovhd (Labor)\*
- Total Variable Ovhd (Labor)\*

\* If the Overhead Basis field on the Work Center form's Scheduling tab is set to include labor, the system updates these fields.

**Note:** The system creates a setup transaction the first time any labor is backflushed for an operation tied to a job. For production schedules, if you specified Setup Hours on the PS Item Routing, the system creates a setup transaction for every PS Release when any labor hours are backflushed.

### Backflushing Machine Hours

When the **Backflush** field is set to **Machine** or **Both**, the system backflushes the machine hours.

Backflushing occurs automatically when you post quantities for completed transactions or report scrap. The number of machine hours backflushed is based on the quantity complete or scrapped quantities multiplied by the machine hours per piece defined on the routing. For the current transaction, the system does not consider machine hours that have been previously backflushed or manually issued.

The manufacturing type determines the routing the system uses for backflushing, as indicated by the chart shown above for backflushing labor hours.

**EXAMPLE:** In this example, Item XYZ has been set up to backflush machine hours. Job 100 for item XYZ requires 30 minutes, or .50/hr machine hours for each completed unit. You manually enter one hour of labor. Later you enter five complete units. The backflushing process automatically issues 2.50 machine hours (.50/hr x five completed units). This is in addition to the one hour you entered manually, for a total of 3.50 machine hours.

Material transactions and inventory journal transactions are created with costs from the work center record. The system creates a machine job transaction each time machine costs are backflushed.

These fields are updated on the Job Operations form:

- **Total Run Hours (Machine)**
- **Total Fixed Ovhd (Machine)\***
- **Total Variable Ovhd (Machine)\***

\* These fields are updated if the **Overhead Basis** field on the Work Centers form's **Scheduling** tab is set to include machine.

## Examples: Backflushing and Control Points

Backflushing Example #1 illustrates backflushing as it works for jobs. Operation 30 is designated as a control point. If you enter a transaction and post it for quantity complete of 5, then the system will assume that the quantity 5, was also completed for operations 10 and 20. (This also assumes that this is the only transaction that has been posted against this job.)

### Backflushing Example #1

Operation	Quantity	Control Point Complete?	Complete?
10	5	No	Yes
20	5	No	Yes
30	5	Yes	Yes
40	0	No	No
50	0	Yes	No

For jobs, if you complete the operation which serves as a control point, the prior operations tied to the control point will be completed. From the example above, if you keyed a transaction for Operation 30, Complete?, "Yes," Operations 10 and 20 will have records created as a result that would complete them.

The system does not assume that all operations or control points must have transactions entered and posted for them. The system does not require or validate that previous operations or control points have been posted. Using the same example, you can post Operation 50 with a quantity complete of 5 and Complete, "Yes," without having posted operation 30, or any other previous operation.

The system will not prevent you from doing this. However, only Operation 50 (and Operation 40 that is tied to it), will backflush. The system will not go back and backflush Operation 30 (and Operations 10 and 20 that are tied to it). This is illustrated in Backflushing Example #2.

### Backflushing Example #2

Operation	Quantity	Control Point Complete?	Complete?
10	0	No	No
20	0	No	No
30	0	Yes	No
40	5	No	Yes
50	5	Yes	Yes

## About Backflushing Materials

You can designate multiple backflush locations for the same material. You specify the backflush location at the material level. With this method, you can manufacture one item on two production lines, each of which has different backflush locations specified.

### Note:

- Backflushed lot/serial tracked materials always use the default warehouse.
- You cannot backflush recursive materials on a job or estimate job BOM (that is, if they are the end item and a material component on the same BOM). An item is recursive if the job or estimate job is a rework order.

### Hierarchy of Backflush Locations

There are four levels of backflush locations. You do not have to use all four levels, but you must designate at least one backflush location if you plan to backflush the material. The system checks each level in a particular sequence; if the first level is blank, it moves on to the next level, and so on:

- The first level the system checks is the **Backflush Location** field on the Materials record. If the specified location does not exist for the item, the system creates the location record automatically and then backflushes from it.
- If the material's Backflush Location field is blank, the system searches for an item location that references the operation's Work Center. If the specified location does not exist for the item, the system creates the location record automatically, then backflushes from it.
- If there is no location associated with the operation's work center, the system checks the **Backflush Location** field on the **Controls** tab of the Items form.
- If the **Backflush Location** field on the Items form is blank, the system uses the **Backflush Location** specified on the Inventory Parameters form.

At any point in this validation process, once you specify a backflush, the system uses that location to backflush from, regardless of what locations might be set up at a higher level. For example, if the material/operation level has a specified backflush location, the system uses that location during backflushing, regardless of what you set up for the material at the item location/work center, Items - Controls, or Inventory Parameters levels.

**Note:** The system also uses a hierarchy for estimated and current materials. It uses the same logic detailed above for a job material or a production schedule material.

### Inventory Parameters

If you leave backflush locations at all four levels blank, you cannot perform backflushing. The system displays an error message when the **On Hand Neg** check box is selected on the Inventory Parameters form and you did not indicate a backflush location. In this situation, you must specify a backflush location at some level in the hierarchy in order to backflush.

### Items - Controls

You can set up materials to be backflushed by selecting the **Backflush** field on the **Controls** tab of the Items form. You can override this setting for each material on the BOM.

**Note:** The backflush item and control point settings from the work center display default values from one of the operations form (Current Operations, Job Operations, Production Schedule Item Operations, Production Schedule Release Operations, and Estimate Operations) that specifies that work center. However, on the operations form, you can override the default values for the backflush item and backflush location.

### Item Location/Work Center Floor Stock Location

A floor stock location is associated with a work center on the Location form. The Floor Stock Replenishment Report uses only this relationship when it calculates what is needed to fill floor stock locations for production.

### Material/Operation

You must establish a routing, comprised of operations, before you can attach materials to it. On the Operations form, you indicate what is backflushed: labor hours, machine hours, or both. You can also specify whether the operation is a control point. On the Materials form, you can define whether an item is backflushed and a location from which to backflush it.

### Backflush Default Hierarchy Example

EXAMPLE: Click "here" on page 182 for an example that demonstrates the source of default backflush locations for a job based on this setup.

### Performing Backflushing of Materials

The BOM and the location hierarchy, which you set up, control the materials to be backflushed and the backflushing location used for each material.

When you post quantities for completed transactions or report scrap, backflushing occurs automatically. The quantity of components backflushed is based on the quantity complete or scrapped quantities, multiplied by the quantity per defined on the BOM. Components you have previously backflushed or manually issued are not considered for the current transaction.

The manufacturing type determines the BOM the system uses for backflushing, as indicated by the following chart:

Manufacturing Type	BOM Used in Backflushing
Job	Job BOM
Production Schedule	Production Schedule release BOM
JIT Production	Current BOM

EXAMPLE: In this example, item XYZ has been set up to backflush materials. Job 100 for item XYZ requires two pounds of material A for each completed unit. You manually issue two pounds of material A to Job 100. Later, you enter a transaction for five complete units. The backflushing process automatically issues 10 pounds (two pounds x five completed units). This is in addition to the two pounds that were manually issued, for a total of 12 pounds.

## About End of Period Costing

The system bases earned amounts on the item's standard routing. Earned amounts accumulate only when you complete quantities for the production schedule and when you report JIT production.

When you report production, backflushing uses the production schedule routing to calculate materials and hours. If you report production through a JIT transaction, backflushing uses the current routing for the item.

You can also issue labor and/or machine hours and materials manually. You post actual costs (backflushed and manual) to work centers.

The system posts variances between earned and actual costs when you run the End of Period Costing activity.

Cost performance measurements emphasize production costs for the work center, but do not provide detailed measurements for particular production schedules, JIT transactions, or their routings and end items.

### Actual Materials, Labor, and Machine Hours

**Actual Materials:** Issue the actual materials that are needed to fulfill the requirements of a production schedule or JIT production to the respective work centers, using one or both of these methods:

- Manual issue through the Work Center Material Transactions form
- Automatic backflushing when production is reported to a production schedule, JIT production through the Production Schedule Complete Transactions form or the Just-in-Time Production Transactions form.

The system stores all WIP costs at the work center. You can view WIP costs on the Work Centers form, **Accum Amt** tab.

**Actual Labor hours:** Post actual labor hours worked on a production schedule or JIT production to the respective work centers, using one or both of these methods:

- Manual posting through the Work Center Labor Transactions form
- Automatic backflushing when production is reported to a production schedule, JIT production through the Production Schedule Complete Transactions form or the Just-in-Time Production Transactions form.

The system stores all WIP costs at the work center. You can view WIP costs on the Work Centers form, **Accum Amt** tab.

**Actual Machine hours:** Post actual machine hours that are used for a production schedule or JIT production to the respective work centers, using one or both of these methods:

- Manual posting through the Work Center Machine Time Transactions form.
- Automatic backflushing when production is reported to a production schedule, JIT production through the Production Schedule Complete Transactions form or the Just-in-Time Production Transactions form.

The system stores all fixed and variable overhead WIP costs on the Work Centers form, **Accum Amt** tab.

## What Happens During Entry and Posting of Transactions

The system posts manual transactions when you enter them; there is no batch processing. In contrast, you must perform an additional step to post unposted job transactions after entering them.

The system adds WIP costs to their respective WIP buckets on the Work Centers form, **Accum Amt** tab, when you enter the transaction.

Each work center has associated WIP costs. When you move finished goods into inventory, the system takes the earned costs from each work center on the routing.

When backflushing, JIT production ignores control points. The system processes all operations, and backflushing occurs where appropriate.

When you enter transactions, you do not hit variance accounts. The system does not record variances until you run the End of Period Costing activity.

See "Example" on page 192.

## Scrap

When you report a scrapped quantity on the Production Schedule Scrap Transactions form, the system does the following:

- First, it stores backflushed costs as WIP for the reported operation, and for operations after the prior control point.
- Second, it removes from WIP the total cost of the scrapped goods (determined by the PS routing) for that operation, along with the cost of all prior operations for each work center.

**Note:** The system does not remove setup costs or cost of materials issued by lot from WIP.

- Third, it posts the accumulated WIP costs of the scrapped goods to the new scrap expense account.

When you run the End of Period Costing activity, the system deducts scrap expense from actual costs before determining the variance. (The system determines the variance by comparing actual costs to earned costs.) Reporting scrapped goods does not increase earned amounts.

See "Example" on page 193.

## Earned Materials Labor and Machine Hours

The system determines earned costs when you move the goods into inventory. At that time, the system refers to the standard routing and accumulates the expected totals or earned costs for the entire routing for each work center.

The system stores these totals for each work center with the same transaction date that was used when you moved the finished goods into inventory.

See "Example" on page 193.

## End of Period Costing

This activity reconciles the differences between the work centers' earned costs (all goods a work center produces during the period, the volume of materials and hours that should have passed through the

work center, and the costs of that volume) and actual costs (the actual volume of materials and hours spent on the work center, and the costs of that volume).

From this reconciliation, the system determines the cost variances and posts them to their respective variance accounts.



**Caution:** While this process runs, you can enter transactions for production and backflush WIP-related costs to the work centers. If transaction dates for these postings fall before or during the Post Through date, the End of Period Costing activity may catch some of the WIP costs for those transactions, but not all of the WIP (depending on the timing). Also, actual values may not balance with earned values, causing variances to be larger than expected. If you run the End of Period Costing activity for either the same period or the next period, all timing variances will wash out.

If an error occurs during the process, all processing for the work center is undone. The system continues to process the other work centers that meet the selection criteria.

### Accounting (Labor Usage for WC)

DR LaborRateVar <Labor Rate Var account>

DR LaborUsageVar <Labor Usage Var account>

CR (LaborRateVar + LaborUsageVar) <Labor WIP account>

\*\*\*OR\*\*\*

CR (LaborRateVar + LaborUsageVar) <Outside WIP account>

See "Example" on page 193.

## Example 1: Actual Materials, Labor and Machine Hours - Costing

This example illustrates accounting transactions that record inside labor:

Actual Hours:

50 hrs @ \$21.00/hr

WC Labor WIP Value: increased by \$1050.00

Accounting:

DR \$1050.00 (Labor WIP Acct)

CR \$1050.00 (Direct Labor Applied Acct)



## Example 2: Scrap Transactions - Costing

Operation	Control Point	Qty Complete	Qty Scrap
10	No	5	
20	No	5	
30	Yes	5	
40	No	5	
50	No		5
60	Yes		

In contrast to production schedule complete transactions, which you record at control points, you report scrap transactions at any operation. In the above example, assume that you reported a quantity of 5 as complete for Operation 30. If you reported a quantity of 5 as scrapped at Operation 50, the system would also backflush for Operations 40 and 50. The system would not scrap 5 or backflush for operation 30 (or prior to it), because it is a control point.

However, the system would calculate the accumulated WIP costs of the scrapped materials for all operations, 10 through 50 inclusive, and move them to the Scrap Expense account.

## Example 3: Earned Materials Labor and Machine Hours - Costing

Earned Hours determined by the standard routing

40 hrs @ \$20.00/hr (\$800.00)

The system moves production to inventory at the rolled cost of the standard routing cost: \$800.00

WC Labor WIP Value: decreased by \$800.00

Accounting:

DR \$800.00 (Inventory Acct)

CR \$800.00 (Labor WIP Acct)

## Example 4: Accounting (Labor Usage for WC)

Actual Hours: 50

Earned Hours: 40

Actual Cost: \$1050.00

Earned Cost: \$800.00

Var Hrs: 10

Var \$: \$250.00

LaborUsageVar:  $10 * \$20 = \$200.00$

LaborRateVar:  $\$250.00 - \$200.00 = \$50.00$

WC Labor WIP Value: decreased by \$250.00

Accounting:

DR \$200.00 (Labor Usage Var account)

DR \$50.00 (Labor Rate Var account)

CR \$250.00 (Labor WIP account) for an inside WC

## About Reports For Backflushing

The Job Pick List activity prints a list of all materials with quantities required to perform the job. Optionally, material issue transactions are posted in place of manual entries. backflush items appear on the pick list. They are not automatically issued as a result of running this report. In addition, they show a quantity to issue of zero, and have a comment "BACKFLUSH ITEM" on the pick list.

You have options to print the Job Transactions Report to include or exclude backflushed material transactions. You can also exclusively select backflushed transactions. This report verifies items issued to a job both manually and/or in combination with backflushing.

Job Operation Status Report will indicate whether an item is backflushed and the backflush location.

Indented Job BOM Report and Single Level Where Used Report would also be helpful in tracking where backflushing is used.

## Reversing a Job Transaction

If you posted a run, setup, machine, or move transaction with incorrect hours or quantities, you can reverse the transaction. To reverse the transaction, enter another transaction with the same employee, job, operation, transaction date, etc., but with negative hours and quantities.

You can reverse the entire transaction or only the incorrect amount:

- To completely reverse the transaction, enter the negative of the total hours and/or quantity completed by the original transaction
- To reverse only the incorrect amount, enter only the negative of the incorrect amount

When you post this transaction, all of the fields posted by the original transaction will be reduced, including:

- operation quantity complete and moved

- quantity received in the subsequent operation
- operation hours and total cost
- job WIP totals

If the original transaction moved pieces into inventory, the negative transaction will pull the pieces back out of inventory to the last operation and decrease the quantity complete on the job.



**Caution:**

If you are reversing a transaction for pieces that should not have been completed at an operation, you must enter the negative transaction against the same operation the original transaction had been entered against. When posted, the negative transaction will pull those pieces back from the "move to" operation to the operation you are posting the transaction against.

For example, if you entered 100 complete at operation 30 and moved them to operation 40, and only 90 were completed, you should enter a transaction for -10 against operation 30. That will reduce the quantity complete and quantity moved at operation 30 and the quantity received at operation 40 to 90.

## Data Collection

If you enter job transactions through a data collection solution, you must enter the reversing transactions at the end of your employee shift or on the next day.

## Avoiding Future Incorrect Transactions

You can avoid entering incorrect job transactions by using the **Perform Additional Validation** option on the Shop Floor Control Parameters form. This option validates your transactions as you enter them, preventing you from entering incorrect quantities and allowing you to correct the errors before posting the transactions.

