



Infor CloudSuite Business Multi-Site Planning Guide - Cloud Edition

Release 9.01.x

Copyright © 2017 Infor

Important Notices

The material contained in this publication (including any supplementary information) constitutes and contains confidential and proprietary information of Infor.

By gaining access to the attached, you acknowledge and agree that the material (including any modification, translation or adaptation of the material) and all copyright, trade secrets and all other right, title and interest therein, are the sole property of Infor and that you shall not gain right, title or interest in the material (including any modification, translation or adaptation of the material) by virtue of your review thereof other than the non-exclusive right to use the material solely in connection with and the furtherance of your license and use of software made available to your company from Infor pursuant to a separate agreement, the terms of which separate agreement shall govern your use of this material and all supplemental related materials ("Purpose").

In addition, by accessing the enclosed material, you acknowledge and agree that you are required to maintain such material in strict confidence and that your use of such material is limited to the Purpose described above. Although Infor has taken due care to ensure that the material included in this publication is accurate and complete, Infor cannot warrant that the information contained in this publication is complete, does not contain typographical or other errors, or will meet your specific requirements. As such, Infor does not assume and hereby disclaims all liability, consequential or otherwise, for any loss or damage to any person or entity which is caused by or relates to errors or omissions in this publication (including any supplementary information), whether such errors or omissions result from negligence, accident or any other cause.

Without limitation, U.S. export control laws and other applicable export and import laws govern your use of this material and you will neither export or re-export, directly or indirectly, this material nor any related materials or supplemental information in violation of such laws, or use such materials for any purpose prohibited by such laws.

Trademark Acknowledgements

The word and design marks set forth herein are trademarks and/or registered trademarks of Infor and/or related affiliates and subsidiaries. All rights reserved. All other company, product, trade or service names referenced may be registered trademarks or trademarks of their respective owners.

Publication Information

Release: Infor Cloudsuite Business (Industrial) 9.01.x

Publication Date: July 21, 2017

Document code: csbi_9.01.x_csbimsicg_cl_csbus_en-us

Contents

About this guide.....	9
Resulting tools.....	9
Planning worksheet.....	10
Contacting Infor.....	12
Chapter 1: Determining your corporate structure.....	13
Creating a flowchart that shows your hierarchy.....	13
Creating a SiteEntity spreadsheet.....	14
Background information.....	15
Company hierarchies.....	16
Chapter 2: Multi-site vs. multi-warehouse.....	17
Multi-site considerations.....	17
Deciding whether you need multi-site.....	18
Background information.....	18
Financial considerations.....	18
Manufacturing considerations.....	21
Payroll/Human Resources considerations.....	22
Operations considerations.....	23
Administration/technical requirements considerations.....	26
Warehouses overview.....	26
Chapter 3: Multi-site per database vs. one site per database.....	31
Chapter 4: Entities.....	35
Updating the flowchart.....	35
Updating the SiteEntity spreadsheet.....	36
Background information.....	36
Entities overview.....	36
Sites that report to an entity.....	36
Setup of entities and the reporting structure.....	37
Multiple currencies and consolidation.....	38
Combined vs. consolidated reporting.....	38
Chapter 5: Number of sites that are required.....	39
Considerations.....	39
Updating the flowchart.....	40

Creating a list of currency codes.....	40
Updating the SiteEntity spreadsheet.....	40
Background information.....	41
Material transfers between sites.....	41
Centralized and decentralized order entry.....	44
Functions where entity data is not available.....	45
Using multiple currencies.....	46
Chapter 6: Grouping sites.....	49
Example.....	49
Creating a list of potential groups.....	50
Updating the SiteEntity spreadsheet.....	50
Background information.....	50
Chapter 7: Intranets.....	53
Considerations.....	53
Background information.....	53
About intranets.....	54
Sending or receiving Business Object Documents from multiple sites on an intranet.....	54
Chapter 8: Sharing data between sites.....	57
Considerations.....	57
Updating the flowchart.....	57
Creating a ReplicationRules spreadsheet.....	58
Background information.....	58
Replication with multiple sites per database.....	58
Default replication categories.....	58
Replicating Site Admin.....	62
Replicating A/P and A/R.....	62
Replicating multi-site information for Home forms.....	63
Replicating Manufacturer Item.....	63
Replicating Centralized Order Entry and Inventory/Transfers.....	63
Sharing vendors, customers, or items between sites.....	64
Replicating financial information.....	66
Replicating dimensions.....	68
Replicating shared currency.....	68
Replicating planned transfer orders (Planning).....	69
Replicating external financial (EXTFIN) data.....	70
Initializing parameter table data.....	71
Replicating Invoice Builder data.....	71
Replicating Journal Builder data.....	72
Replicating Purchase Order Builder data.....	72

Replicating Voucher Builder data.....	73
Replicating Customer and Vendor Portal data.....	74
Replicating Service data.....	74
Replicating data via BODs (ESB).....	75
Recommended transactional replication rules.....	75
Chapter 9: Sharing some data through master sites.....	77
Considerations.....	77
Updating the flowchart.....	78
Creating a list of the tables or categories controlled by the master site.....	78
Updating the SiteEntity spreadsheet.....	78
Updating the ReplicationRules spreadsheet.....	79
Background information.....	79
Intranets with shared tables and master sites.....	79
Shared user tables.....	79
Frequently asked questions about shared tables and master sites.....	80
Maintaining customer, vendor or item data for other sites in the intranet.....	81
Chapter 10: Frequency of data replication.....	83
Update the ReplicationRules spreadsheet.....	83
Background information.....	84
Replication Rules form.....	84
Chapter 11: Using the Application Event System.....	87
Chapter 12: Add-on products and modules.....	89
Updating the flowchart and spreadsheets.....	89
Background information.....	89
APS.....	89
Analytics.....	92
Country packs and localizations.....	93
Credit Card Interface.....	93
DataViews and Critical Numbers.....	93
EDI.....	93
Microsoft Excel add-in.....	94
Factory Track.....	95
BOD-enabled applications (ION).....	95
Industry packs.....	96
Mobile.....	96
Office Application Search Service.....	96
Outlook.....	96
Configure Price Quote (CPQ).....	97

Portals.....	97
Service.....	99
Chapter 13: Licensing.....	101
Considerations.....	101
Creating a License spreadsheet.....	102
Background information.....	102
Chapter 14: Naming rules.....	103
Considerations.....	103
Updating the flowchart and spreadsheets.....	104
Determining prefix use for records in different sites.....	104
Background information.....	104
Prefixes.....	104
Item numbers.....	106
Chapter 15: Incorporating later changes.....	107
Revising your flowcharts and spreadsheets.....	107
Background information.....	107
Changes to your reporting structure.....	107
Appendix A: Replication overview.....	109
About replication.....	109
_All tables.....	110
Replication categories and rules.....	112
Using categories with rules.....	112
Point to point replication.....	113
Intranets.....	113
Master sites and shared tables.....	114
Multiple sites in one database.....	114
Replicating _all tables.....	115
Replicating base tables.....	115
Replicating shared tables.....	115
Appendix B: Replication category tables.....	117
A/P category.....	117
A/R category.....	119
CCI Centralized Order Entry category.....	121
Centralized Order Entry category.....	121
Customer Portal category.....	125
Dimensions category.....	126
ESB category.....	126

EXTFIN category.....127

EXTFIN Customer category.....128

EXTFIN Vendor category.....128

G/L category.....128

Initialize _All Parameters category.....131

Inventory/Transfers category.....131

Invoice Builder category.....134

Journal Builder category.....135

Ledger Consolidation category.....136

Ledger Detail category.....137

Manufacturer Item category.....138

Multi-Site Home form categories.....138

Multi-Site BOM Builder category.....138

Multi-Site Customers category.....139

Multi-Site Items category.....139

Planning category.....140

PO - CO - Across Sites category.....141

Purchase Order Builder category.....142

Service - Global Incidents category.....143

Service - Global Scheduling Shared Partners category.....144

Service - Global Service History category.....144

Service - Global Units category.....145

Service - Multi-Site SRO Copy category.....145

Shared Currency category.....146

Site Admin category.....146

Vendor Portal category.....147

Voucher Builder category.....147

Glossary.....149

About this guide

Use this guide to plan for a multi-site configuration of Infor CloudSuite Business. When you have multiple sites, the configuration of your system becomes much more complex. If you answer the questions in this guide before you begin configuration, you will be prepared, and your configuration should go more smoothly.

This guide has these sections:

- **Planning worksheet:** Lists the questions, in order, that you should ask and answer when planning your system. Each step lists one or more tasks that must be completed while answering the question.
- **Chapters that perform these functions:**
 - Address each of the questions from the planning worksheet
 - List the planning tasks you must perform to answer the questions
 - Provide background information that helps you complete the planning tasks
- **Glossary:** Defines CloudSuite Business and industry-specific terms used in this guide

Resulting tools

After you complete the planning tasks, you should have these tools:

- A flowchart showing all of the sites and entities in your logical/financial hierarchy, and the shared data relationships between them
- A `SiteEntity` spreadsheet that lists, for each site, information such as site name, type, site group, intranet name, and so on.
- A `ReplicationRules` spreadsheet that lists each of the rules that is required to replicate data between the sites
- A `Licensing` spreadsheet that lists each license module (along with the number of users) needed for each site
- A list of your planned currency codes
- Lists of your planned site groups and master site tables

Use these tools, along with the *Infor CloudSuite Business Multi-Site Implementation Guide*, to set up your system. Keep the information in the spreadsheets up to date, to use for reference as your system changes.

Samples of these tools are available in a ZIP file in the Documentation area on the Infor Xtreme support site.

Planning worksheet

Use this worksheet to determine the questions to ask and the tasks that must be completed before you start installing your system. The questions are addressed in more detail, with information to help you answer them, in the chapters of this guide.

Step	Question	Tasks
	What is your corporate structure? What hierarchical structure is required for financial reporting, for sharing of data and for transfer of materials?	<ol style="list-style-type: none">1 Draw a preliminary flowchart in pencil or using a computer modeling tool like Visio®. You will probably change the flowchart several times.2 Create a <code>SiteEntity</code> spreadsheet containing a preliminary list of the site names and types.
	Multi-site or multi-warehouse? Understand the differences between using sites and warehouses in CloudSuite Business.	Decide whether your company really requires a multi-site setup. If not, skip the rest of this document.
	Do you need separate entities? If yes, then how many different entities do you need?	<ol style="list-style-type: none">1 Update your flowchart with any changes to the site/entity reporting structure.2 Update your flowchart with any changes to the site/entity reporting structure.
	How many sites do you need? Determine the optimal number of sites for your system. Then determine some basic information about each site.	<ol style="list-style-type: none">1 Update your flowchart with any changes to the site reporting structure.2 If your system will have sites/entities with different base (domestic) currencies, make a list of the 3-character currency codes to be used for those base currencies.3 Update your <code>SiteEntity</code> spreadsheet with any changes to the list of sites. For each site, specify the time zone. Also specify the base currency for each site.

Step	Question	Tasks
	<p>How should sites be grouped?</p> <p>Do you need multiple groups for different multi-site functions or users?</p>	<ol style="list-style-type: none"> 1 Create a list of potential Site Groups. 2 Update the <code>SiteEntity</code> spreadsheet to specify which Site Group the site should reside in initially.
	<p>Which data needs to be shared between sites?</p> <p>What categories of data need to be replicated?</p> <p>Which sites need to share that type of data?</p> <p>Does data need to be shared in both directions?</p>	<ol style="list-style-type: none"> 1 Update the flowchart with arrows indicating the categories of data being shared, and the directions the data is flowing. 2 Create a <code>ReplicationRules</code> spreadsheet listing each of the categories you think you will need, in each direction, from each site.
	<p>Should some data be shared through a master site and SQL views rather than through replication?</p> <p>You might decide to set up master sites and shared views for some areas of your system.</p>	<ol style="list-style-type: none"> 1 Update the flowchart with boxes indicating master sites, if used. For data flowing to a master site from using sites, use a different type of arrow. 2 Update the <code>SiteEntity</code> spreadsheet to indicate any sites that are master sites. 3 Create a list of the tables that are controlled by the master site. 4 If some of the rules you thought you would need have been replaced by the use of a master site, remove the rules from the <code>ReplicationRules</code> spreadsheet.
	<p>If you will replicate data, how often?</p> <p>Should you use transactional or non-transactional replication?</p>	<p>Update the <code>ReplicationRules</code> spreadsheet to indicate which rules are transactional or non-transactional. If using non-transactional rules, specify the interval type and timing.</p>
	<p>Will you be using the event system?</p>	<p>Consider how event data might be replicated.</p>
	<p>What modules or products will interface with each site?</p> <p>Will you be interfacing CloudSuite Business to an external financial interface, EDI, an Infor BOD-enabled application, etc.?</p>	<p>Update the flowchart and spreadsheets as needed, if you decide to rearrange your sites due to add-on product requirements.</p>
	<p>How many licenses (and what types) do you need?</p> <p>Determine which users - and how many users - will need to work in multiple sites.</p>	<p>Create a <code>License</code> spreadsheet listing the sites and the license modules and number of licenses required for each site.</p>

Step	Question	Tasks
	Is your naming scheme logical? Name sites, configurations, intranets, and site groups to indicate the logical structures and relationships.	Update the flowchart and spreadsheets with any name changes.
	How easily will your structure incorporate later changes? Think about how radical changes to your company hierarchy may affect the structure.	Revise your flowchart and spreadsheets if you decide to rearrange your hierarchical structure.

Note: Planning and implementing a multi-site system is not a simple task. We recommend that you discuss the process and the results of your planning decisions with Infor Consulting Services prior to implementation.

Contacting Infor

If you have questions about Infor products, go to the Infor Xtreme Support portal.

If we update this document after the product release, we will post the new version on this website. We recommend that you check this website periodically for updated documentation.

If you have comments about Infor documentation, contact documentation@infor.com.

Determining your corporate structure

1

What hierarchical structure does your company require for these functions:

- Financial reporting
- Sharing of administrative data
- Sharing of customer orders and invoices
- Transfer of materials

Creating a flowchart that shows your hierarchy

Draw a flowchart showing your company's site hierarchy. Use a pencil, or use an application that lets you draw flowcharts on your computer, because you will probably change the flowchart several times. You will use the information in later chapters of this guide to help you refine your flowchart.

Example

This multi-site corporation has facilities in three locations. The flowchart shows the logical structure of the company, set up as sites and entities.

Illinois Facility: This is the corporate office and the United States divisional office. It has a warehouse for shipping and receiving. Orders shipped from this site are invoiced from this site. This facility also processes all sales orders, receivables and payables for the other two sites.

California Facility: The California facility has a warehouse for shipping and receiving. Orders shipped from this site are invoiced from this site. One product line is sourced at this location from a Mexican vendor.

Ontario Facility: The Ontario facility is the Canada divisional office and has a warehouse for shipping and receiving. Orders shipped from this site are invoiced from this site. A product line from this location is sourced from a Canadian vendor.

The arrows show how different categories of data would flow between the sites and entities at this example company. Do not be concerned with the arrows yet, although you may want to include some possible data flows.

Categories will be explained later. See "Sharing data between sites" on page 57.

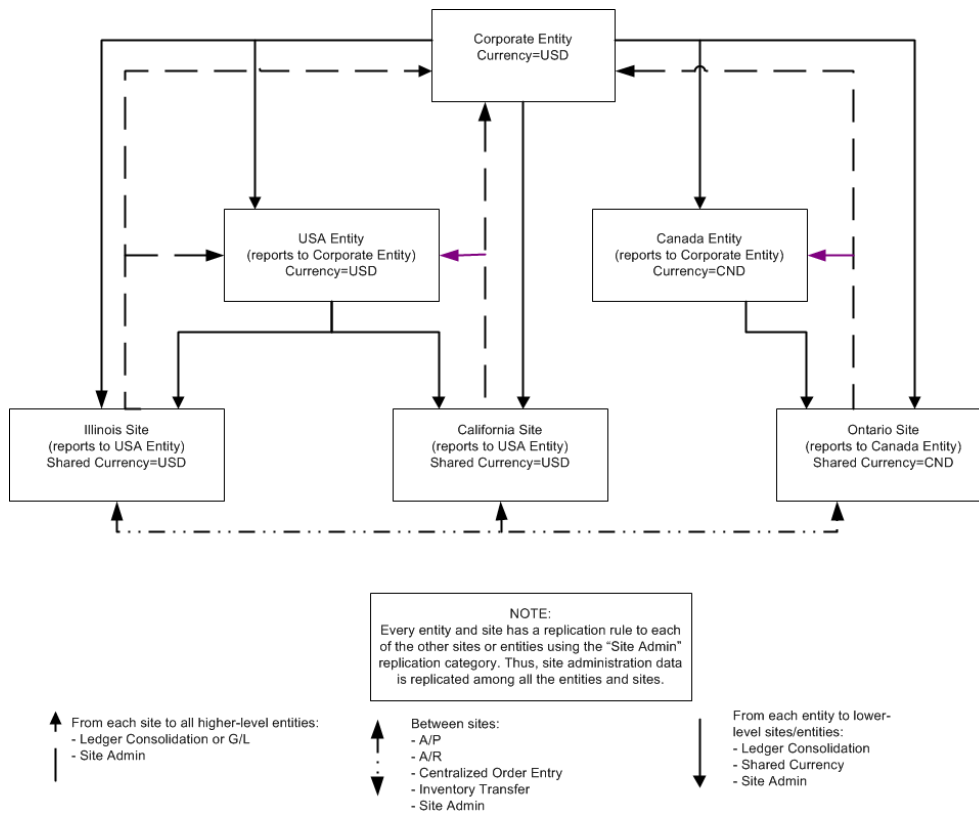

Creating a SiteEntity spreadsheet

Create a spreadsheet named SiteEntity that lists this information for each potential site:

- **Site ID:** Up to 8 characters. Avoid using these special characters in site names or IDs: \ (back slash) / (forward slash) : (colon) * (asterisk) ? (question mark) " (double quote) < (left arrow) > (right arrow) | (vertical bar) (embedded space)
- **Site Name:** Up to 60 characters, including spaces. This is the long name for the site. It appears along with the Site ID on several forms. (In some forms, this field is truncated.) For example, if your Site ID is ONT, your Site Name could be Ontario.

You might want to include the type (site or entity) information in the name; for example, "Ontario Site."

- **Site Description:** Up to 40 characters, including spaces. This text could describe both the location of the site and what it is used for. For example, "Illinois Site - Distribution."
- **Site Type:** Specify Site or Entity. See the background information section for more information about how to determine this.

You will add more columns for each site in later chapters. This information is used when you create and configure sites.

Background information

You can perform these multi-site functions in CloudSuite Business:

- Move or transfer material or items between sites or warehouses.
- Combine data from sites at financial entities.
- Ship to common customers and receive from common vendors.
- Share administrative functions between sites.
- Centralize payment processing (between sites having the same currency).
- Centralize customer order entry.
- Centralize maintenance of customer, item and vendor data at a master site for an intranet.
- View Accounts Payable and/or Accounts Receivable transactions across sites.
- View item availability across sites.
- View "Home" form information across sites.
- Copy an item's bill of materials (BOM) between sites.
- Maintain and validate licensing across sites on an intranet.
- Use "builder" forms to enter manual journal entries, vouchers, purchase orders, invoices and credit memos for multiple sites at a central location.

Determine which site and warehouse is best for shipping orders, based on distance, quantity available, and planned production time.

Logically, a site is any place where work is done.

Thus, a site can correspond to company headquarters, a manufacturing plant, a distribution center, or a legal company that requires financial reporting. Even if all of these facilities share a single physical building, each may be considered a logical site.

Sites can report to financial reporting units called entities. An entity is a separate instance that maintains accounting periods, chart of accounts, and currency, and reports on its consolidated ledger and budgets. Sites can report to only one entity, and they must share characteristics with the entity such as account numbers and base (domestic) currency.

For more information about setting up and using entities, and making sites report to them, see the background information in "Entities" on page 35.

Sites and entities are defined during CloudSuite Business database server installation. Additional information about each site and entity is set up on the Sites/Entities form.

This information includes the intranet used by the site and any linked sites. You can set up replication rules to transfer data between sites, or you can specify master sites that maintain data for multiple sites.

For information on these features, see "Sharing data between sites" on page 57 and "Sharing some data through master sites" on page 77.

You can also set up site groups to combine data for sites performing related functions, for example, AR payment generation or subcomponent manufacturing. Sites in a group do not have to report to the same entity, but they do need to share the appropriate data through replication. See "Grouping sites" on page 49.

You can add or remove sites later, as required by your situation.

You can also create new entities, add a new site to an existing entity, and/or move sites from one entity to another.

Company hierarchies

A corporate entity can have child entities, for consolidating reporting at different levels, and each entity can have child sites. Each site can contain multiple warehouses, and each warehouse can contain multiple item stockroom locations to store inventory.

This chart shows the hierarchical relationship between components of a company:

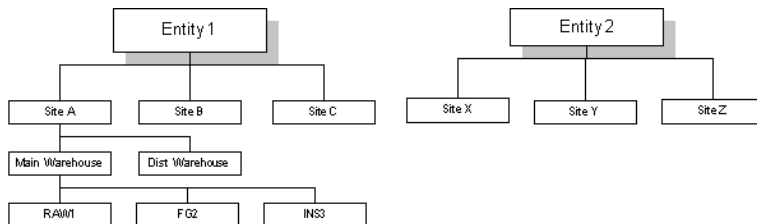

Sites A, B, and C are grouped to form Entity 1. There are two warehouses under Site A: Main and Dist. There are three locations shown under the Main warehouse: RAW1, FG2, and INS3. Entity 2 has three sites (X, Y, and Z) reporting to it.

Does your system require multiple sites, or is a single-site, multi-warehouse system better for your company?

You must understand the differences between a multi-site environment and a multi-warehouse environment, so you can decide which one your company should use.

Multi-site considerations

A multi-site system includes multiple sites, site-specific controls, and the ability to transfer demands and materials between sites through centralized order entry and transfers. Multi-site functionality was designed for businesses that have relatively autonomous sites. If most of your company activity is centralized, such as planning, purchasing, and accounting, then multi-site might not be the best option.

These are reasons to use multiple sites:

- The same items can be made at different plants using different manufacturing methods.
- Sites will have separate control of jobs, POs, COs, and inventories. (Within one site, special prefix numbering can be used to keep the data organized.)
- Inventory levels can be monitored across sites.
- Goods can be transferred between sites, with or without recognizing sales and profits.
- Sites can use different charts of accounts or different base currencies.
- Centralized order entry is available to link customer demands between sites.

In addition, it is easier to break out financial information for different sites, rather than for different areas within one site.

Multi-warehouse

Multi-warehouse allows the setup of multiple warehouses within one site. Revenue and expense information for goods and services is controlled through the use of Product Code distribution accounts. All other company information, such as chart of accounts, invoices, vouchers, and scheduling, is shared between the warehouses.

These are reasons for using one site with multiple warehouses:

- Centralized MRP and planning.
- A manufacturing process, within a routing, moves between manufacturing locations.
- Centralized purchasing, centralized entry of A/P vouchers, or accounting that creates many journal entries across locations, for example, allocating corporate expenses among all sites.

Note, however, that the "builder" features in CloudSuite Business allow you to handle some of these centralized requirements in a multi-site environment. See the online Help for information about the PO, voucher, invoice and journal builders.

Deciding whether you need multi-site

Use the background information to determine whether your company needs a multi-site system.

- 1 When you read the questions in the tables, write a "weight factor" from 0 (not important to your company) to 5 (very important) next to each question. Also, write down whether your answer to the question indicates the need for multi-site or single-site. If neutral, write "neutral."
- 2 When you have completed all the questions, add up your scores for multi-site vs. single-site. This score should give you some insight about which setup is best for your company.
- 3 Read the background information on warehouses to better understand how they are used in Cloud Suite Business.
- 4 If you decide that you need a multi-site system, then continue with the next chapter.
If a single-site, multi-warehouse setup will meet your needs, you are finished with the evaluation process, and you can skip the rest of this guide.

Background information

Consider your company's responses to these questions to determine whether to use multiple sites or one site with multiple warehouses. The symbols to the left of the descriptions indicate, for each question, whether the multi-site or single-site option is better, worse, or neutral:

- + Better
- - Worse
- = Neutral

Financial considerations

Financial considerations include General Ledger, Accounts Payable, and Accounts Receivable questions.

General Ledger

G/L question	+/-	Multi-site	+/-	Single site with Multi-Warehouse
Are there multiple reporting entities (Balance/P&L)?	+	Multi-Site supports Profit & Loss and Balance Sheet statements by site.	=	Single Site supports P&L statements by distribution codes. A Balance Sheet is only available for the whole site. If unique Balance Sheets are required, they must be constructed manually. Warning: this process is manual and complex.
Is consolidated financial reporting required?	+	Multi-site supports the consolidation of reporting units within a site, multiple sites at the entity level, and multiple entities at the corporate level.	=	If multiple, non-linked databases are used, export/import utilities can be used to transfer G/L information.
Do you have completely different account numbers in different areas of the company?	+	Chart of accounts are the same at sites as at the entity they report to, or the sites contain a subset of the entity's chart of accounts. If completely different account numbers are used in different areas, then separate entities must be created.	-	Only one Chart of Accounts is supported for all areas.
Are inter-company sales present?	+	Inter-company (sites) sales are recognized at the site and eliminated at the entity level through the Ledger Consolidation activity.	-	This is not supported.
Are entries required at the entity level?	+	Financial entries can only be entered at the site level. A separate legal, business entity, like a holding company, may require a separate site. Note: Entries can also be made at each site to an inter-company 'offset' account that will net zero when a consolidated financial is run.	-	Financial entries can be entered within the site. (There is no separate "entity" level.)
Is reporting performed in multiple currencies?	+	Different sites may have different base (domestic) currencies, but each site must have the same domestic currency as the entity it reports to.	-	One base reporting currency is available.

G/L question	+/-	Multi-site	+/-	Single site with Multi-Warehouse
How are financial statements maintained?	=	Financial statements should be maintained in each site or entity. Statements can be copied across sites. Sites typically run statements for their own ledgers. Entities typically run statements for the sites that report to them. However, you can run statements for any combination of sites from any site or entity, as long as the appropriate data is being replicated.	=	Financial statements exist at the site level.
Do you need to manually input journal entries for multiple sites from one location?	+	From a central site, you can use Journal Builder to enter journal entries for multiple sites.	=	There is only one site and one set of journals.

Accounts Receivable:

A/R questions	+/-	Multi-site	+/-	Single site with multi-warehouse
Is centralized order entry required?	=	Centralized and decentralized order entry strategies are supported.	=	Centralized and decentralized order entry strategies are supported.
Is consolidated invoicing performed across sites?	=	Multi-site does not support consolidated invoicing. Invoicing is controlled at the site level. However, you can use the Invoice Builder to create and post invoices and credit memos for the current site and other target sites for customer order shipments and returns	+	Consolidated invoicing is supported.
Is centralized cash application required?	=	Multi-site supports centralized or decentralized cash application. Cash application across sites using the same base currency is supported. Cash application across sites using different base currencies is not supported.	=	Centralized cash application is supported. All warehouses must maintain the same base currency.

Accounts Payable:

A/P questions	+/-	Multi-site	+/-	Single site with multi-warehouse
Is consolidated vouchering across sites required?	=	From a central site, you can run Voucher Builder to create vouchers and adjustments for other sites when generating vouchers from PO Receipts. You can also create manual vouchers across sites; however manual adjustments across sites are not supported.	=	Supported via a single site.
Are centralized payments required across sites?	=	Multi-site supports this functionality.	=	Supported via a single site.
Do the payment sites have the same currency?	=	All sites sharing payment information must have the same base currency.	=	All warehouses must maintain the same base currency.
Are centralized commissions required?	=	Multi-site supports centralized commission payment across sites.	=	Supported via a single site.
Is centralized vendor maintenance required?	=	Multi-site, with a master site setup, supports centralized adding and maintaining of most vendor data. Deletion must be done at sites.	=	Supported via a single site.

Manufacturing considerations

Manufacturing considerations include job, production schedule, and material resource planning questions.

Job and Production Schedule:

Job/PS questions	+/-	Multi-site	+/-	Single site with multi-warehouse
Do job operations extend across warehouses or sites?	=	Multi-site does not support the planning of production across sites. All operations must be only for the local site. All outside production must be treated as an outside purchase in logic with different item numbers. Multi-site supports the copy of current and single level BOMs across sites.	=	One warehouse per site is designated for production; any additional warehouses are designated for storing inventory. This is also true for multi-site with multiple warehouses per site.

Multi-site vs. multi-warehouse

Job/PS questions	+/-	Multi-site	+/-	Single site with multi-warehouse
Are capacity and manufacturing schedules viewed across warehouses or sites?	=	Multi-site does not support the scheduling of production across sites. All outside production must be treated as an outside purchase in logic with different item numbers.	=	One warehouse per site is designated for production; any additional warehouses are designated for storing inventory. This is also true for multi-site with multiple warehouses per site.
Do you make the same item at different plants using different processes?	+	If your item run-times or routings are different at different manufacturing sites, you probably need a multi-site system.	-	In a single current site, you can have only one routing and BOM for an item. (However, jobs can have different routings/BOMs for the same item.)

MRP:

MRP questions	+/-	Multi-site	+/-	Single site with multi-warehouse
Is centralized planning required?	-	Multi-site through the use of linked MRP allows demands to be pushed to other sites. There is no other method to consolidate material requirements. Planned orders can only be performed at the local level, not across sites.	+	Supported via a single site.
Do different areas have different planning and scheduling requirements?	+	Planning and scheduling are done per site.	-	Not supported.

Payroll/Human Resources considerations

Payroll/HR questions	+/-	Multi-site	+/-	Single site with multi-warehouse
Is payroll performed at a "global" level?	-	Multi-site does not support payroll processing across sites.	+	Supported via a single site.
Do employees work in more than one division?	=	Employees working in multiple sites must be set up and processed at each local site.	=	Departments must be set up to support this process.
Will sales representatives be	-	If sales representatives will be paid through payroll, all commis-	+	Supported via a single site.

Payroll/HR questions	+/-	Multi-site	+/-	Single site with multi-warehouse
paid through payroll?		tion processing will be processed at the site.		

Operations considerations

Operations considerations include order entry, purchasing, inventory control, and transfer order questions.

Order Entry:

Order entry questions	+/-	Multi-site	+/-	Single site with multi-warehouse
Is centralized order entry required across sites?	+	Centralized and decentralized order entry strategies are supported.	=	Supported via a single site.
What order and invoice number logic is used across sites?	=	CO prefixes must be used in each site to properly identify and track orders. Invoice sequences will be maintained at the site level. The "Site ID" is added as a prefix to the invoice number.	=	CO prefixes are available within a site.
Are shared customers required?	=	Multi-site, with a master site setup, supports centralized adding and maintaining of most customer data. Deletion must be done at sites.	=	One customer master is utilized within the site.
Are site-level customer credit limits required?	+	If centralized order entry is set up between sites, and the same customer number is defined in multiple sites, then that customer's credit limits, posted balance, and on order balances display the total for that customer from all the shared sites. Local (unshared) customers allow local credit limits and balances.	=	Supported via a single site.
Is invoicing required by order with central order entry?	+	Invoicing is performed by the ship site. If one line on an order is shipped from one site and another line is shipped from another site, two invoices will be generated. However, you can use the Invoice	=	Supported via a single site.

Multi-site vs. multi-warehouse

Order entry questions	+/-	Multi-site	+/-	Single site with multi-warehouse
		Builder to create and post invoices and credit memos for the current site and other target sites for customer order shipments and returns.		
How are performance measurements reported?	=	Order entry information, such as ship date vs. due date, is maintained at the site level.	=	Order entry information, such as ship date vs. due date, is maintained at the warehouse level.
Is global pricing maintenance required?	-	All pricing logic is maintained at the site level. If central order entry is used, the price that defaults to the order line comes from either the site that is taking the order or from the ship site (depending on order entry parameters). The ship site cannot update the quantity or the price on an order that originated in another site. No mass update utility exists across sites for maintenance.	+	Supported via a single site.
Are sales analysis and booking required across sites?	+	All sales analysis and booking information is maintained at the site level. However, on the Salesperson Home form you can see the information for various sites, or for all sites.	=	Supported via a single site.
Are global salespersons and commission logic used?	=	If centralized order entry is used, the central order site must contain all possible salespersons. Commission information cannot be input at the central order entry level. Commission distributions must be set up and maintained at the site level.	=	Supported via a single site.

Purchasing:

Purchasing questions	+/-	Multi-site	+/-	Single site with multi-warehouse
Is consolidated requirements planning required?	-	Multi-site has no ability to provide requirements planning across sites. All requirements are planned at the site level.	+	Supported via a single site.
Is centralized purchasing per-	=	Builder purchase orders can be entered at one site to create pur-	=	Supported via a single site.

Purchasing questions	+/-	Multi-site	+/-	Single site with multi-warehouse
formed across sites?		chase orders for other sites. Maintenance of these POs is then done at the individual sites.		
Is centralized receiving performed across sites?	-	Multi-site has no ability to provide centralized receiving across sites. All receiving is performed at the site level.	+	Supported via a single site.
Are shared vendors required?	=	Multi-site, with a master site setup, supports centralized adding and maintaining of most vendor data. Deletion must be done at sites.	=	One vendor master is utilized within the site.

Inventory:

Inventory questions	+/-	Multi-site	+/-	Single site with multi-warehouse
Is standardized item number logic used across sites?	=	Multi-site, with a master site setup, supports centralized adding and maintaining of most item data. Deletion must be done at sites.	=	Supported via a single site.
How is materials planning performed?	=	Item availability across sites is only available using Item Availability (with drilldown). No reports combine on-hand balances across sites.	=	Supported via a single site.
Is item cost different at different warehouses?	=	You can set item costing at either the warehouse or site level.	=	You can set item costing at either the warehouse or site level.

Transfers:

Transfer questions	+/-	Multi-site	+/-	Single site with multi-warehouse
What transfer controls, visibility, and documents are required?	=	The proper transfer process will be related to the controls, visibility, and documents that the customer requires.	=	Same logic.
Is profit recognized from inter-site material transfers?	+	Multi-site allows you to recognize and eliminate inter-site transfer profits. The transfer pricing logic is linked to the price matrix and transfer pricing. The elimination of	-	Warehouse transfers are supported. Inter-company sales are not supported.

Transfer questions	+/-	Multi-site	+/-	Single site with multi-warehouse
		inter-company profits is linked to the Ledger Consolidation activity.		

Administration/technical requirements considerations

Admin questions	+/-	Multi-site	+/-	Single site with multi-warehouse
Where is system administration performed?	=	Users can be global or local. Authorizations for global users can be set locally at each site, or globally.	=	Supported via a single site.

Warehouses overview

Each site has at least one warehouse, designated as MAIN, which is created during system installation. In most cases, this also becomes the default, or primary, warehouse for the site, but you can change the default.

Multiple warehouses

Many companies have more than one location in which to store inventory, so you can add warehouse locations to the list of warehouses available for various transactions. To add warehouses, use the Warehouses form. You can also use this form to view and update information for all warehouses in the system.

Item stockroom locations

Before you can show inventory in your warehouses, you must establish item stockroom locations. Each warehouse can contain multiple item stockroom locations where you store inventory for lot-tracking and other audit-trail purposes. Add these item stockroom locations using the Locations form.

Item/warehouse records

When you add an item to the system using the Items form, an item/warehouse association (or record) for the item is created automatically. For this record, the default warehouse is used as defined in the **Default Whse** field on the Inventory Parameters form. An item stockroom location is also automatically

created for the item, using both the default warehouse and the default location defined on the Inventory Parameters form.

If you want to stock an item at multiple warehouses, you must create an item/warehouse association for each warehouse location. To create these item/warehouse associations, use the Item/Warehouse form. You can then use the Item Stockroom Locations form to add quantities of the item to locations within the designated warehouse.

Consignment warehouses

There are two ways to use a consignment warehouse:

- You can specify some of your warehouses as vendor consignment warehouses, where vendor materials are stored until you decide to consume or purchase them.
- You can specify a customer's warehouse as a customer consignment warehouse, where you store some of your materials until the customer decides to consume or purchase them.

For more information regarding the setup of customer and vendor consignment warehouses, see the online help topic about consignment warehouse setup.

Warehouse default values

Many of the forms where you can select a warehouse use a default warehouse setting. In all cases, you can override this default setting by selecting a different warehouse.

The values for the default warehouse settings on different CloudSuite Business forms come from various places. The About Warehouses help topic explains where the various default warehouse values are set up.

About the current warehouse

Many forms take as their default value the warehouse that the system recognizes as the "current warehouse," which can change on a per-user, per-session basis. When the system designates the current warehouse," it uses these rules:

- When you log in, the system designates the warehouse from the your profile as the current warehouse for that session. This setting is defined in the Whse field on the Users form.
- If that field is blank, the system uses the Default Whse field on the Inventory Parameters form.
- At any point after logging in, you can change the current warehouse setting in the Change Warehouse form.

Note: This current warehouse setting is valid only on a user-session basis. That is, the current warehouse setting can be different for each user logged in to the system. This setting is only in effect as long as you are logged in. After you log out, the setting reverts to your default user setting, if any.

Setting warehouse defaults manually

There are several ways to manually change warehouse default settings:

- Change the system default warehouse using the **Default Whse** field on the Inventory Parameters form.
- Change a user's default current warehouse setting using the **Whse** field on the Users form. See the About the Current Warehouse help topic.
- As a user, change the current warehouse setting for your current session using the Change Warehouse form. See the About the Current Warehouse help topic.
- Change the default warehouse for a range of customers using the Set Default Warehouse form.
- Change the default warehouse for a range of vendors using the Set Default Warehouse form.
- Change the default warehouse for a range of users using the Set Default Warehouse form.

Containers

Inventory movements can be expedited through the supply chain by replacing single inventory transactions with bulk (container) inventory transactions. Inventory in CloudSuite Business can be grouped into containers that are assigned to a stock location for a warehouse. Each container is assigned a unique container number, and incoming inventory can be added into the container. You can specify a container number during an inventory transaction, and the system performs all the single-level inventory transactions transparently.

How MRP, APS, and MPS Processor use warehouses

The MRP, APS, and MPS Processor planning functions view on-hand inventory as the total on-hand quantity (that is, On Hand - Qty Reserved for customer orders) at all nettable stockroom locations across all warehouses at the site.

For example, suppose you have a customer order for 150 of an item. The item is stored at three warehouses: A, B, and C. Warehouse A contains 50 on-hand, warehouse B contains 50 on-hand, and warehouse C contains 50 on-hand. When you run MRP or APS Planning or the MPS Processor, the system allocates on-hand from all 3 warehouses to satisfy the demand, and no planned orders are needed. This planning behavior occurs regardless of any specific warehouse specified on the customer order.

Dedicated remote warehouses

In some situations, you may want a warehouse to serve only local-area orders and not orders entered at the main facility. In the above example, suppose you wanted to "protect" the inventory at warehouse C so it could be used only for specific customer orders. To do this, select the Dedicated Inventory field on the Warehouses form for that warehouse.

When you run MRP or APS Planning or MPS Processor, the system ignores the inventory in the dedicated-inventory warehouse. Likewise, these planning functions ignore all demands and supplies that specify a dedicated-inventory warehouse.

Be aware of these restrictions on dedicated inventory:

- You cannot select the **Dedicated Inventory** option for a warehouse selected as the default warehouse on the Inventory Parameters form.

- You cannot perform the Get ATP or Get CTP function on a line item (for example, on the Customer Order Lines form) that is associated with a dedicated-inventory warehouse.
- The Planning Detail and Planning Summary forms do not display any inventory transactions related to dedicated-inventory warehouses.
- The exception message "Initial On-Hand Quantity Negative" (which appears on the Planning Detail form and on the Exceptions Report) does not consider inventory at dedicated-inventory warehouses.
- The planning functions ignore demands set to ship from dedicated-inventory warehouses and supplies set to supply dedicated-inventory warehouses.

Dedicated inventory and planning of transfer orders

Outgoing transfer orders are not planned as demands at the current, local site if the warehouse specified as the From warehouse is a dedicated-inventory warehouse. However, that transfer order is planned as a supply if it is sent to a warehouse at the same site that is a non-dedicated inventory warehouse (that is, if the To warehouse is one in which the **Dedicated Inventory** field is not selected).

Incoming transfer orders are not planned as supplies at the current, local site if the To warehouse is a dedicated-inventory warehouse. However, that transfer order is planned as a demand if it is received from a warehouse at the same site that is a non-dedicated inventory warehouse (that is, if the From warehouse is one in which the **Dedicated Inventory** field is not selected).

Distribution warehouses

Distribution warehouses are dedicated-inventory warehouses that are designated to plan intra-site transfers using the transit time, in days, between the default warehouse and a distribution warehouse. For these transfers, the original demand is ignored, but the pre-planning process generates planned transfer orders based upon the demand at the distribution warehouse. New planned intra-site transfers represent demand for the planning engines.

Sourcing percentages of planned orders

You can set rules that automatically split planned transfer orders for a certain item or product code between multiple sites and warehouses, specifying what percentage of the order comes from which site/warehouse. For more information, see the online help about creating source rules for planned orders.

Determining the best site and warehouse to fulfill an order

When you fulfill customer orders, use the Multi-Site Item Sourcing form to determine the driving distance between each site/warehouse and the Ship To address, using the Google Distance API. You can use the distance, along with the quantity available at the warehouse and the planned production time, to select the best source site and warehouse for an order.

Moving inventory between locations

Use transfer orders or multi-site quantity moves to move inventory from one warehouse to another (within the same site or across sites). See "Material transfers between sites" on page 41 for more information.

A hypothetical shipping and receiving scenario, in which both warehouses are within the same site, is shown below:

- Warehouse A transfers to Warehouse B.
- Warehouse A ships to a Transit Location, which is maintained at Warehouse B.
- When Warehouse B receives the item, it is moved from the Transit Location to a Stock Location within Warehouse B.

This diagram shows the process.

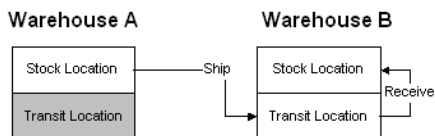

Moving quantities between locations

Use these options to move inventory:

- Use the Multi-Site Quantity Move utility to move inventory between different sites, warehouses within the same site, or locations within a single warehouse, you can.
- Use the Warehouse to Warehouse Bulk Transfer utility to move inventory between two warehouses within the same site.
- Use the Quantity Move utility to move inventory between different locations within a single warehouse.

Transferring lot- and serial-tracked items

When you transfer a lot-tracked or serial-tracked item from a warehouse at one site to a warehouse at another site, there are issues to consider regarding whether the lot or serial number exists at each site and in what location it will be created. These issues are described in the online help.

Counting warehouse inventory

Counting inventory is done at the warehouse level. There are two primary ways to count the existing inventory at each warehouse:

- Performing a cycle count: Count your inventory quantities at each warehouse and stock location on a scheduled, cyclical basis. You can define cycle-count triggering options at each warehouse to instruct the system to create a cycle count record each time a particular inventory event occurs at that warehouse.
- Performing a physical inventory: Perform a physical count of the inventory in a warehouse. This process prints tags and/or sheets for personnel to use when they count the inventory in stock and then manually enter that information into the physical inventory system.

Multi-site per database vs. one site per database



This chapter explains the differences between an environment with multiple sites all in one SQL database, versus an environment with each site in a different SQL database.

In a cloud environment, all sites are in the same database.

This table shows the advantages and disadvantages of each type of environment:

Topic	Multiple sites per database	One site per database
Maintenance	<p>Pro: Because you have only one database, backups, administration of indexes, etc. are easier.</p> <p>Con: Backups and restores take longer to complete for all sites participating, and will take progressively longer over time, exponential to the number of sites. Increased time to run index rebuilds, analysis, statistics, etc.</p> <p>Con: Only one recovery model can be selected.</p>	<p>Pro: Backups and restores can be done on the databases (sites) during the various sites' maintenance windows, based on each site's operations low utilization or down times.</p> <p>Con: Administration of multiple databases for indexes, statistics and database maintenance is more complex and potentially more time-consuming.</p> <p>Con: Data recovery, high availability, and disaster recovery could require coordination between multiple database (site) failover points for all of the application databases.</p>
Upgrades and issue fixes	<p>Pro: Because you have only one database, upgrades are easier.</p> <p>Pro: You have one copy of the stored procedures and functions that is used by all of the sites in the database. So when you upgrade or install bug fixes, you only have to update one database.</p>	<p>Pro: Single sites can be upgraded to new versions of CloudSuite Business, rather than having to simultaneously train and convert all sites at once. (However, this gets more complicated if the site is replicating data to other sites.)</p> <p>Con: You have multiple copies of the stored procedures and func-</p>

Multi-site per database vs. one site per database

Topic	Multiple sites per database	One site per database
	<p>Con: When you apply single fixes that involve core database logic (method calls) such as stored procedures, etc., the fix impacts all sites.</p>	<p>tions in each site SQL database that is used by the specific site. So when you upgrade or install issue fixes, you must update all site databases.</p>
Processing speed	<p>Pro: If all your sites are in one database, tasks that require performance of queries, stored procedures or functions at another site may display results more quickly at the originating site, because they can take advantage of shared memory.</p> <p>Con: Writes to the log file of a single instance database with multiple sites could create a bottleneck at the log file. Log file maintenance is more important in this scenario.</p>	<p>Pro: Each site can be separately administered and tuned to best perform for the usage of that site (memory allocation, backup schemes, number of active sessions, etc.)</p> <p>Con: Collecting and querying data from multiple databases is less efficient. You need multiple execution plans and connection sets.</p>
Data integrity	<p>Pro: Keeping data in sync between sites is easier, especially after a restore</p>	<p>Con: You could lose some multi-site data integrity when you backup and restore individual databases in various states that are participating in a multi-site environment.</p>
System down	<p>Con: If the database goes offline, all sites are down. If you have to do a system restore or backup, it affects all sites in the database.</p>	<p>Pro: When you take a site database offline, there is little or no impact on other site databases.</p>
Scalability	<p>Con: The database server that is processing data for the single database with multiple sites will need to scale up as the database grows in size and usage. The ability to distribute site load across multiple database server infrastructure/instances would not be effective.</p>	<p>Pro: If sites reside in their own databases, you can distribute of those databases across multiple database server infrastructure/instances.</p>
Objects database	<p>Con: Only one objects database can be used with all sites in the application database</p>	<p>Pro: Sites can use different objects databases.</p>
Licensing	<p>Con: A shared license is required.</p>	<p>Pro: You can license each site separately, or use a shared license.</p>

Topic	Multiple sites per database	One site per database
Portability	Con: Use the “Add new site to an Existing Database” option to copy the site to a new database, but no option to remove one site from an existing multi-site database.	Pro: Sites are physically separate in their own database, so portability is less of an issue. A site and its contents can be moved or removed if necessary.
SQL requirements	Con: The Enterprise version of SQL Server is required.	Pro: Either the Standard or Enterprise version can be used, except when other factors such as required memory, etc. indicate that the Enterprise Edition is needed.
Other considerations	<p>Pro: UETs and events are shared between sites. (This can also be a “con.”)</p> <p>Con: You cannot isolate site-specific procedure changes, either programmatically or from a SQL security perspective. A change made to a stored procedure is visible to all sites in the same application database. Coding to exclude sites could be implemented in custom stored procedures.</p> <p>Con: If you turn on performance tuning or troubleshooting (for example, Profiler, execution plan estimation, etc.), it impacts all sites.</p> <p>For tables that contain large binary fields, rebuilding an index locks the table for all sites.</p>	<p>Pro: Sites are logically separate, each with a complete set of data and programs.</p> <p>Pro: Performance tuning and troubleshooting have less impact on the other sites running on the infrastructure.</p>

Consider these key points about entities, and read the background information about entities and consolidation. This information can help you decide whether your system requires separate entities and, if so, how many entities are needed.

- An entity exists for the specific purpose of financial consolidation, reporting, and currency translation. If your company does not require any of those features, then you do not need to define any entities.
- The chart of accounts must be the same at the sites as at the entity they report to, or the sites must contain a subset of the entity's chart of accounts.
- Financial entries can only be entered at the site level. A separate legal, business entity, for example, a holding company, may require a separate site that reports to it.
- Financial statements can be run in either an entity or a site.
- Each site must have the same base (domestic) currency as the entity it reports to. If you have areas of the company using different base currencies, and those areas must provide financial information to a reporting hierarchy, then you must have at least one entity for each currency. An entity reporting to another entity does not need to use the same base currency; the currency will be translated during financial consolidation to the next entity level.
- A site can report to only one entity. A site is not required to report to an entity, in which case its financials are not consolidated.
- Does your company frequently acquire other companies or sell off divisions? If so, it is better to "loosely couple" different divisions/companies, and keep the financial reporting separate (that is, different entities).
- It is not necessary to have a balanced financial hierarchy.
- The more levels of entities you have, the more complex the administration. Simpler is better, when possible.
- Depending on your needs, you may be able to use multi-site groups instead of creating an entity. See "Combined vs. consolidated reporting" on page 38 and "Grouping sites" on page 49.

Updating the flowchart

Update the flowchart with any changes to the reporting structure.

Updating the SiteEntity spreadsheet

If you have added or removed entities or sites, change the list in the spreadsheet.

Background information

Use this information to better understand the concepts.

Entities overview

In a multi-site environment, you can specify a hierarchy of financial entities that operating sites report to. A financial entity is a level of business operation with these components:

- A complete set of financial statements
- Its own domestic currency code, which must be shared by sites that report to it, and its own currency rates, which may or may not be shared by reporting sites/entities
- Its own chart of accounts and accounting periods, which must be shared by reporting sites. (Reporting entities do not have to share these characteristics with a higher-level entity.)

Each entity allows no business activity aside from period, chart and currency maintenance, and the reporting of its consolidated ledger and budgets.

If ledger detail is replicated to the entity from the sites, you may be able to "drill down" to view detail down to the level of the originating transaction. (This assumes that any other categories required for the transaction-level detail are also being replicated. However, having this level of G/L and other transaction detail replicated to the entity often does not make sense from a performance standpoint.) Otherwise, you must log into the specific site in order to view the transaction detail.

Sites that report to an entity

The majority of operations at sites reporting to an entity remain the same as at a non-reporting site, including the financials. However, if a site reports to an entity, the site's Chart of Accounts is now owned by the entity and is copied from it. In the site's local copy of the Chart of Accounts, you can delete records in order to use a subset of the entity's accounts.

The site must use the domestic currency of its entity, but it may use its own rates.

Journal entries must be made at the site level in order to properly recognize expenses, etc. No transactions are allowed at the entity level. All distribution journals must be posted at the sites.

Consolidation utilities must be run at the reporting sites to copy the posted ledger transactions and budgets into the entities all the way up the hierarchy.

A site is not required to report to an entity, in which case its financials are not consolidated.

Setup of entities and the reporting structure

Entering operational data such as customers and vendors is not necessary for entities. Maintenance and reporting of financial data is allowed.

Defining the hierarchy

To define or change the hierarchy of your sites and entities, several utilities are available in CloudSuite Business:

- **Change Reports to Entity:** Use this utility at the reporting site/entity to specify the next-level entity to which this site/entity reports. This utility can also be run if a site is sold and needs to be removed from the financial consolidation structure.
 - If this utility is run at a site, you can only change the **Reports To Entity** to a financial entity that has the same base (domestic) currency, Chart of Accounts and accounting periods. Also, the system verifies that all accounts defined at the site already exist at the financial entity. If this validation fails, the change is not allowed, and a report is created detailing the failures. If chart records exist at the site that do not exist at the entity, you can use the Multi-Site Chart Copy Utility to copy the site's Chart of Accounts to the financial entity. If no Chart of Accounts or accounting periods have been set up yet at the site, this Change Reports To Entity utility will copy them from the entity to the site.
 - If this utility is being run at a financial entity at any level, the closing balances for each account at every site beneath the financial entity are calculated and consolidated all the way up the hierarchy. Then the Reports-To value is changed. All the Reports To account mappings for the entity's Chart of Accounts must be corrected to map to the Chart of Accounts of the new Reports-To financial entity.
- **Multi-Site Chart Copy:** Use this utility at the entity to copy the Chart of Accounts down to the reporting sites and entities.
- **Ledger Consolidation:** Use this utility at the reporting site or entity to consolidate any unconsolidated ledger records (by mapping accounts and unit codes and converting currencies) up to and including the cutoff date. Each ledger record will be consolidated all the way up the hierarchy. The ledger at this site will be marked as consolidated. For higher level entities, the newly created ledgers are stored, using that entity's chart of accounts and base currency. The utility validates this information:
 - The hierarchy is valid.
 - The accounts map correctly.
 - The unit codes map correctly.
 - The currencies convert properly.
- **Budget Consolidation:** Use this utility at the reporting site or entity to consolidate all previously unconsolidated site budgets and plans through the cutoff date. All entities in the hierarchy that are senior to the current site must be replicating G/L or Ledger Consolidation data with the current site. Each budget and plan for each account is consolidated all the way up the hierarchy; the budget and plan at the current site remains unchanged. For higher level entities, the newly created budgets and plans are stored using that entity's chart of accounts, base currency, and financial periods. If a site

or entity enters and leaves a hierarchy in the course of a single year, the original budget/plan will be replaced with the later one.

- **Set Ledger Consolidated Flag:** Use this utility to rebuild an entity. Use it to reconsolidate entities whose data was lost, corrupted or discarded due to a change in corporate structure.

Multiple currencies and consolidation

When you use multiple currencies in a consolidated environment, be aware of these requirements:

- The base (domestic) currency must be the same at all sites reporting to an entity. However, you may set up the sites so they can maintain their own currency exchange rates - or you may want to maintain the rates only at the entity. See "Replicating shared currency" on page 68.
- In each entity's Chart of Accounts, the currency translation method and the exchange rate type are specified for each account. To comply with FASB52 or GAAP standards, revenue and expense accounts should use the Average translation method, and asset and liability accounts should use the End translation method.
- The currency table of the entity is the one used for translation during the consolidation. Sites use the domestic currency of their entity, so there is no currency translation at this level.

Combined vs. consolidated reporting

Financial statements can either show combined data from a group of sites, or consolidated data from an entity and its reporting sites.

If you want to create sample financial statements before changing a hierarchical structure, to see what the combined data from multiple sites will look like, you can mimic the new structure by using multi-site group IDs and combined financial statements. After creating a multi-site group that contains all the sites you want to combine, you can specify this site group when running certain General Ledger reports. To ensure meaningful reports, the sites must share the same Chart of Accounts format.

Even after you have set up a consolidated environment, you can still run combined financial statements for a group of sites.

When you run consolidated financial reports from the entity, all sites that report to the entity must have run the Ledger Consolidation utility. When the financial statement is run, no currency translation is required, because the data at the entity level is already translated into the entity's currency and Chart of Accounts. Also, since no multi-site group IDs are specified, it looks only at the information in the entity. Therefore, consolidated financial reports run much faster than combined financial reports.

Number of sites that are required

5

Determine the optimal number of sites for your system. Then determine some basic information about each site.

Simpler is better. When you have fewer sites, the less the administration is less complex.

Considerations

Base currencies

When a site or entity is created, the Site Currency is defined, also known as the "domestic" currency or the "base" currency. The currency codes to use must be decided before the sites are created.

When a site in one country executes a transaction with a customer or vendor in another (foreign) country using a currency other than the domestic currency, one currency is converted into another to settle the transaction. This conversion from one currency to another creates gains and losses depending on the currency exchange rate specified at the site. Some forms and reports show amounts in the site's domestic currency, while others display amounts in the customer/vendor's currency but can be translated to the domestic currency with the click of a button.

Customers and vendors can be set up to support transactions in currencies other than their defined "default" currency. Totals are still in the default base currency. For more information, see the online help topics about multiple currencies for customers or vendors.

All sites reporting to the same entity must use the same domestic currency as the entity.

Time zones

A time zone must be specified for each site when the site is created. The time zone for the site is independent of the time zone for the server. Multiple sites running on one server can have different time zones. The time zone for each site should be appropriate for the users of that site.

When transactions are replicated between sites, the transactions are stored in `_all` tables and use the date and time the transaction occurred at the creating site.

The only exceptions to this are dates stored in the `currdate_mst` and `curr_uk_mst` tables. Those dates will shift to show the date and time at the local site. This allows currency rates to be current for the date and time at the local site.

Corporate financial entries and manual adjustments

If you have an entity, you must have at least one site under the entity in order to enter transactions - since no transactions may be entered at the entity.

Even if you have other sites under an entity, you might want to have a separate site used for entering corporate journal entries that do not apply to a specific site. For example, operational expenses for a private jet should be allocated equally to the ILL and CA sites, but the expenses should not appear in either the ILL or CA consolidated financials.

Manufacturing plants

How many manufacturing plants do you have? Generally each of those will require a site. Or consider whether the different plants could be handled through multi-warehouse features. See "Multi-site vs. multi-warehouse" on page 17.

Balance sheets

If different areas of the company require unique balance sheets, each area must be in a separate site.

Updating the flowchart

If you add or remove sites, or move them around in the hierarchy as a result of the information in this chapter, update your flowchart.

Creating a list of currency codes

If your system will have sites or entities with different base (domestic) currencies, make a list of the three-character currency codes to use. You might also want to define codes for other foreign currencies that will be used in the system.

Updating the SiteEntity spreadsheet

Update this spreadsheet with any changes to the list of sites and entities. For each site and entity, specify this information:

- The base currency code
- The time zone in which the site operates

Background information

Use this information to better understand the use of multiple sites when transferring items, when using centralized order entry, or when calculating currency rates.

Material transfers between sites

There are two different ways to move or transfer items or material between sites:

- Use the Multi-Site Quantity Move form to perform simple, quick movements of inventory where there is relief of inventory in one site and receipt in another. A multi-site quantity move does not require paperwork and assumes no transit time.
- Use a transfer order for planning and controlling stock movement and availability. When a transfer order requests that the material be transferred from the shipping site to the receiving site, the shipping site must be aware of this transfer order. If the material is being transferred to the receiving site from the shipping site, the receiving site must be aware of this transfer order. Once the transfer order is entered at one site, the system creates a complementary record automatically at the other site. In addition to in-transit visibility, transfer orders support these features:
 - Landed cost
 - Full cross-referencing capability with jobs, purchase orders, and customer orders
 - The ability of the "From" site to use price codes
 - Shipping paperwork and pro-forma invoices
 - Multiple currencies
 - Lot/serial controls

Both multi-site quantity moves and transfer orders support the use of lots and serial numbers.

In order to do moves or transfers between sites, there must be a replication rule set up for the Inventory/Transfers category between the sites. See "Sharing data between sites" on page 57.

Price codes

The price code determines the costs that are used in multi-site quantity moves or transfer orders. You can set up price codes for sites that report to different entities. If both sites are in the same entity, price codes are not used.

Accounts

Multi-site transfer accounting automates inter-company financial transactions and inter-company financial consolidation. CloudSuite Business provides parameter setup for profit/cost eliminations, and offers separate account tracking for inter-company profit, cost, accounts receivable, accounts payable, sales, and cost of sales.

Accounts must be set up to establish site relationships and default account numbers that will record inter-entity financial transactions. When initiating either a move or a transfer between sites, the costs and account numbers that default for the transaction come from the Inter-Site Parameters form and are relative to the site that initiated the transaction.

Costing

Multi-site quantity moves do not use the To and From in-transit accounts of journal entries. Instead, inventory moves directly to the buyer's inventory accounts.

Transfer orders can cause in-transit entries to occur; the act of shipping and receiving inventory moves the inventory in and out of in-transit accounts.

Transfer order costing will function in one of two ways depending on the setting of the Posting Method parameter, found on the Inter-Site Parameters form. These are the available posting methods:

- Intra-Entity: Transfers occur at cost between sites.
- Inter-Entity: transfers occur with revenue between sites, with the From Site making a profit.

Transit location

A stock location of type "transit" must exist in sites performing transfer orders. This location is used to hold the inventory between the time the shipment is made and the receipt performed.

Free On Board (FOB) site

The **Free On Board** (FOB) field on the Inter-Site Parameters form determines ownership of in-transit inventory. This is the site at which you must specify the location as "transit" for multi-site transfers.

For transfer orders, you can identify the FOB point as either the Ship Site or the Receive Site. You must specify the FOB point for all inter-company movements.

If the FOB point is the Ship Site, transfer of ownership takes place at the time of shipment. Material moves from a location in the Ship Site to a transit location in the Receive Site, and financial ownership changes from the Ship Site to the Receive Site. At receipt time, transactions are created to move the material from the transit location to a standard location at the Receive Site.

If the FOB point is the Receive Site, transfer of ownership takes place at the time of material receipt. Material moves from a location in the Ship Site to a transit location in the Ship Site. At receipt time, transactions are created to move the material from the transit location at the Ship Site to a standard location at the Receive Site. Financial ownership changes at receipt time.

FOB and costing

When a site transfers inventory to another site, inventory cost at the shipping site is relieved against the five cost categories (Material, Labor, Fixed Overhead, Variable Overhead, and Outside Services).

When a site sells inventory to a site in another entity of the company, the Inter-Entity cost of goods sold at the shipping entity is debited against the five cost categories, and inventory is relieved against all five categories.

When a site receives inventory transferred from another site, inventory is received into stock as if it were a purchased item. If the receiving site has employed standard cost, the transferred item comes into inventory using the five cost elements (Material, Labor, Fixed Overhead, Variable Overhead, or Outside Services). If the receiving site uses any other cost type, the cost comes in as Material Only.

See the online help for a list of the supported inter-site financial transaction types and examples that illustrate the different types of inter-site transactions and the resulting journal entries.

Markups

CloudSuite Business supports two types of transfer markups:

- **Profit Markup:** A site within an entity sells product to another site in a different entity at a profit. Profit is defined as any amount added by the selling entity in excess of the cost amount of the inventory shipped. This markup must be eliminated during financial consolidation. From a company-wide standpoint, entities cannot make profits by selling to each other. From Site profit must equal the To Site cost. (A markup may be established by filling in the **Price Code** on the Inter-Site Parameters form. This uses standard pricing logic.)
- **Cost Markup:** One entity or site transfers or sells a product to another entity or site and landed costs are incurred as a result of moving inventory. The seller does not increase costs to cover these expenses. It is the responsibility of the receiving entity to correctly include these costs in inventory. The CloudSuite Business Landed Cost functionality is used to include costs in the buying site's inventory. These costs are true costs to the receiving site, and should not be eliminated during financial consolidation.

Payments

Payments are entered at the From Site and distributed to the To Site.

When posting an A/P payment, the From Inter-Site Asset account is debited and the To Inter-Site Liability account is credited. When posting an A/R payment, the From Inter-Site Liability account is credited and the To Inter-Site Asset account is debited.

Multi-site linked MRP and APS

CloudSuite Business can replicate transfer orders between remote sites. When either MRP or APS creates planned transfer supply orders (PLNs) for components provided by remote supply sites, the planned transfer order is replicated to the supply site as a planned demand transfer order. See "Replicating planned transfer orders (Planning)" on page 69.

Inter-Site Parameters

The Inter-Site Parameters form must be filled out prior to any A/P, A/R, or transfer multi-site activities taking place. These parameters establish the relationship between the sites ("inter" or "intra") and identify the inter-company account numbers to be used during transactions. If your sites are set up to replicate Site Admin data, you can enter these parameters in one site and all the others will update automatically.

Centralized and decentralized order entry

If you want your sites to share customer order data, set up "centralized order entry" replication rules between the sites. This allows either of these types of order entry:

- Centralized order entry, where the company's ordering, A/R payments and/or pricing can be handled at a single site.
- Decentralized order entry, where any site can originate its own orders.

An order's shipment can span several sites: for example, lines 1-3 are shipped from Site A, and lines 4-6 are shipped from Site B. Shipping and invoicing tasks are performed at each shipping site.

When determining whether to implement centralized order entry, consider where Cost of Sales and Revenue are recognized. In centralized order entry, the shipping site incurs the cost and earns the revenue.

Be aware of these notes about multi-site customer orders:

- Credit checking and inventory visibility are provided from site to site.
- Invoice, credit, and debit memo sequences may be used to easily distinguish one site's A/R transactions from another. It is possible to create an open credit memo in one site, post it, and then reapply the credit memo to an invoice in another site. In order to prevent overlapping credit memo numbers from different sites, you should set up different credit memo sequences for different sites.
- The Item Availability form can be used to check inventory levels across sites. It uses the Site Group ID.
- Both the Shipping and Invoicing activities must take place in the "shipping" site. In a multi-site environment, invoicing is performed by each individual site. The originating site invoices only those line items shipping from its site. Other shipping sites will invoice locally for only their line items. In centralized order entry, if the originating site has no inventory, invoicing is done only by the shipping sites, not the originating site. However, if you have Invoice Builder replication set up between sites, users can create and post invoices at one site for items that are shipping from that site and other sites, through the Multi-Site Invoice Posting form.
- A/R cash application can be done centrally, as long as the sharing sites have the same base currency. (In order to do centralized cash applications, A/R replication rules must be set up between the sites.)
- A site can make a payment for an order that originated from another site that reports to the same entity, as long as the necessary data is being replicated between the sites. However, you cannot generate a new draft payment and apply it to multiple invoices, because when an invoice is generated for a draft customer, the system creates a draft record. There is a site-specific one-to-one relationship between an invoice and a draft.

- To pull all default item prices for CO lines from the site originating the order, select **Price from Originating Site** on the Order Entry Parameters form. If this field is not selected, the system pulls the default prices from the site shipping the order line item.
- Customer order cross-referencing (to purchase orders, jobs, etc.) can only be done for the local site.
- You can use prefixes to ensure that orders are unique by site.

Using credit limits and credit hold in a multi-site environment

When you enter or change a credit limit in one site, the credit limit value is changed in all other sites replicating that data. The On Order Balance shown for the customer at each site is the cumulative balance of that customer's orders at all replicating sites. For example, a customer has a credit limit of \$100. Site 1 has one open order for the customer, for \$50. Site 2 has one open order for \$25. ("Open" in this case means Status=Ordered and nothing has shipped.) The customer's record in the Customers form shows an On Order Balance of \$75 in both sites. If you add a new CO Line Item for \$35 in either site, the proposed On Order Balance would be \$110. Even though each site fits under the credit limit, the line item is added as Status=Planned because the proposed On Order Balance has exceeded the credit limit.

In a multi-site environment, the Originating Site of a customer order controls the credit hold status of the customer order for all sites from which the customer order may be shipped.

When you initiate the Order Credit Hold Change Utility in a multi-site environment, the system performs the processing at all sites for the selected customers. The system checks the customer's credit limit against the On Order Balance to determine when the credit limit is exceeded. If a customer's credit limit is exceeded, what happens depends on the shipping site:

- If the shipping site is the originating site of the customer order, the order is placed on credit hold.
- If the shipping site is not the originating site of the customer order, a warning message displays, but the customer order is not placed on credit hold.

Payment hold for vendors

If payment hold is selected for a vendor in an environment where vendors are set up to be the same across sites, then payment hold is selected for that vendor in all sites.

Payment hold does not exist at the purchase order level.

Functions where entity data is not available

Many CloudSuite Business forms include a "Site" field that allows you to select a site or a site group. In some cases, both sites and entities are listed; however, if the data on the form is not applicable to entities, then only sites are listed.

Multiple financial sets of books

If one site is using multi-FSB, and that site is replicating G/L data to other sites, only the standard set of books for the site is replicated to the other sites.

Using multiple currencies

You can define a default currency for each customer and vendor. You can also define customer or vendor currencies other than the default currency, to use for specific sets of customer and vendor transactions. The transaction currency is no longer required to be in the customer or vendor default currency.

The customer and vendor currencies might be different than your company's base (domestic) currency. CloudSuite Business makes this possible through these multi-currency features:

- Maintainable currency rates.
- Transactions that use either fixed or variable rates. To specify a fixed rate for a specific transaction, select the Fixed Rate check box in the transaction's form.
- Euro conversion tools.
- FASB52 compliance.
- Recognition of currency exchange rate gains or losses.
- Customer and vendor transactions can be maintained in the foreign currency but can quickly be translated to your domestic currency.
- Customer and vendor payments are in the currency of the associated bank. Customer payments can be entered in a currency other than the currency of the bank where the payment will be deposited. In that case, the currency will be converted to the currency of that bank.
- Your general ledger maintained in your domestic currency.

Customer amounts can be stored in the system in the customer's default currency. This affects customer orders, estimating, and A/R.

Vendor amounts can be stored in the vendor's default currency. This affects purchase orders and A/P.

In addition to the default currency specified for a customer or vendor, you can define other currencies for a customer or vendor. Certain types of transactions have been modified to support these additional currencies used for the transaction currency.

Thus, if two sites in different countries use the same vendor, but the vendor uses a different currency in each country, you can use the same vendor number in both sites, but specify a different currency to be used for specific types of transactions.

Cash accounts used in bank reconciliations may be stated in non-domestic currencies. Payments are in the currency of the associated bank.

All amounts in journals, ledger, inventory (price and cost), and the shop floor are always stated in domestic currency.

When amounts are posted into journals, they are translated into domestic currency.

Currency master data

Currencies are maintained in the Currency Rates form. Users can enter an unlimited number of date- and time-stamped currency exchange rates. They can also back-date these rates by entering a past date. There are two exchange rates entered:

- The buying rate is used exclusively in purchase orders and A/P.

- The selling rate is used exclusively in customer orders, estimating, and A/R.

In the Currency Codes form, users can specify formats for currency amounts, and accounts to use for currency gains and losses.

For better integration with other applications, we recommend that you use the standard ISO currency codes.

Applying payments

You cannot apply payments to invoices of other sites where the other sites do not have the same base currency as the site entering the payment to apply.

Financial statements

You can print financial statements in different currencies. The exchange rates used to print the report are the rates stored in the site/entity that contains the ledger records being processed. The translations are for display purposes only. No posting of any kind takes place and no gain or loss is calculated.

Translations are defined for each line of the financial statement. You choose to use the buying or selling exchange rate.

Realized and unrealized gains and losses

When a company that is headquartered in one (domestic) country executes a transaction with a company in another (foreign) country using a currency other than the domestic currency, one currency needs to be converted into another to settle the transaction. This conversion from one currency to another creates gains and losses depending on the currency exchange rate.

Realized currency exchange gains and losses can occur when full or partial payments are applied to voucher or invoice amounts.

However, if financial statements are prepared between the date of the original transaction (sale or purchase on account, for example) and the date of the cash receipt or cash payment, and the exchange rate has changed since the original transaction, an unrealized gain or loss must be recognized in the statements.

Consolidated financial statements with foreign subsidiaries

Before the financial statements of domestic and foreign companies are consolidated, the amounts shown on the statements for the foreign companies must be converted to domestic currency. Asset and liability amounts are normally converted to domestic currency by using the exchange rates as of the balance sheet date. Revenues and expenses are normally converted by using the exchange rates that were in effect when those transactions were executed. For practical purposes, a weighted average rate for the period is generally used. The adjustments (gains or losses) resulting from the conversion are reported as a separate item in the stockholders' equity section of the balance sheets of the foreign companies.

After the foreign company statements have been converted to domestic currency, the financial statements of domestic and foreign subsidiaries are consolidated in the normal manner. See the ledger consolidation information in "Entities" on page 35 for more information.

Number of sites that are required

Do you need multiple groupings of sites for different multi-site users or functions?

Consider this information:

- Site groups can be set up to combine data for sites performing related functions, for example, AR payment generation, inventory item availability, or subcomponent manufacturing. Sites in a group do not have to report to the same entity, but they must share the appropriate data through replication or shared tables.
- You can define groups containing different combinations of sites. A site can be included in more than one site group.
- On some activity, utility and report forms, you can select a site group, which allows you to process records for all sites in that group. If you want to process records only for the local site, you leave the site group field blank or, if the field is required, specify a group that contains just the local site.
- You can specify default site groups to use on certain types of forms (for example, A/P activities). You can also specify, for a specific user, the default site group to display when that user opens the Item Availability form.
- Site groups are used to determine which sites you can select when you copy records from one site to other sites in the Multi-Site Items, Multi-Site Customers, or Multi-Site Vendors forms.

Example

This flowchart shows an example of a site hierarchy:

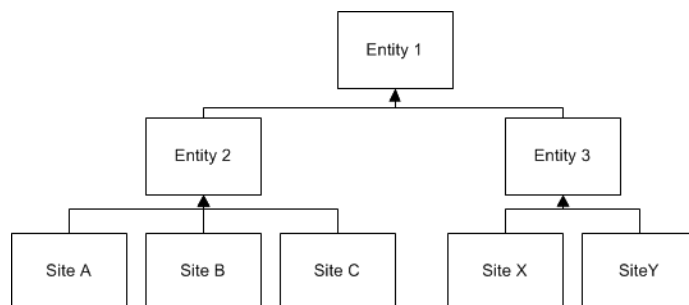

Grouping sites

A product manager is in charge of finished goods that are only manufactured at sites A and Y. All other sites produce sub-components. You can create a Site Group "AY", consisting of only sites A and Y.

Site Group "AY" can then be specified as the default site group for the product manager. Then when the product manager opens the Item Availability form, the system automatically defaults the Site Group field to "AY". In effect, this customizes the product manager's view of the system.

Creating a list of potential groups

Make a list of the site groups your system might use. Later, you can assign these groups to sites through the application's Site Groups form.

Updating the SiteEntity spreadsheet

Update your SiteEntity spreadsheet to specify which site group each site should initially belong to. An initial group is required when you configure the site.

Background information

Review the additional information in "Background information" on page 15.

See the information on combined vs. consolidated reporting in "Entities" on page 35 for examples of how multi-site groups can be used.

This is an example of a form where you can select a site group in order to process records from multiple sites:

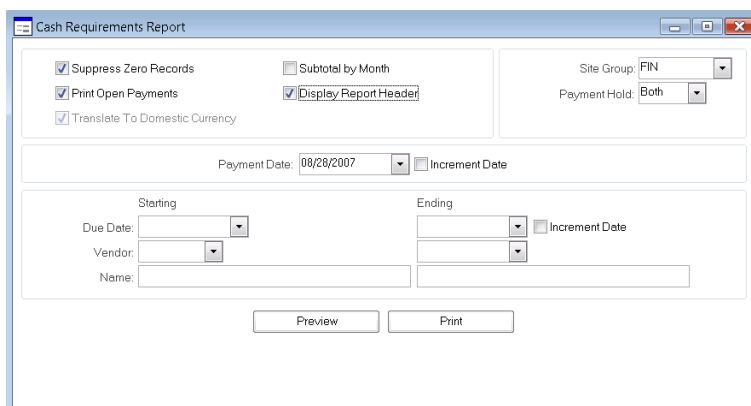

The screenshot shows a window titled "Cash Requirements Report". It contains several sections of controls:

- Checkboxes:** Suppress Zero Records, Subtotal by Month, Print Open Payments, Display Report Header, Translate To Domestic Currency.
- Dropdowns:** Site Group: FIN, Payment Hold: Both.
- Text Fields:** Payment Date: 08/28/2007, Increment Date (checkbox).
- Starting/Ending Section:** Starting Due Date, Vendor, Name; Ending Due Date, Vendor, Name; Increment Date (checkbox).
- Buttons:** Preview, Print.

The Intranet feature provides a way to logically show your LAN/database site setup from within Infor CloudSuite Business. Determine the number of intranets needed, decide on the intranet names, and decide which sites will belong to each intranet.

In most cases, you will need only one intranet. The exceptions are listed in this section.

Considerations

Consider this information:

- There can be only one master site per intranet. For information about using master sites, see "Sharing some data through master sites" on page 77.
- Will you have an external intranet, which allows integration, via replication, to applications other than those based on the Mongoose framework? Replication performed to a site on an external intranet must be non-transactional.
- Clients may be deployed to key customers or suppliers over the internet, allowing them access to specific system features. In this case, you probably should configure your web server components (and the URL for that server on the Intranets form) to use https instead of http, so that the data going over the internet is encrypted.
- Are you planning to have multiple sites send and receive business object documents (BODs)?

Background information

Review this information.

About intranets

CloudSuite Business intranets represent logical groupings of sites in your enterprise. An intranet may represent a grouping of CloudSuite Business sites that exist together on a high-speed network, and for which you want common administration. (Common administration can include replication or creation of master sites.) An intranet may also represent an external non-CloudSuite Business system, allowing you to set up replication rules between CloudSuite Business sites and external systems.

Use the Intranets form in the application to define information about your logical intranets. Then use the Sites or Sites/Entities form to assign your sites to an intranet.

External intranet

Create an external intranet if you need to set up replication between sites on one of your CloudSuite Business intranets and an external system or an application.

For such external systems or applications, the only attributes that matter will be the intranet name (so you can define "sites" on the Sites or Sites/Entities form that represent instances of external systems), the transport method (see below), and the URL. When you have defined sites on such an external intranet, you can then create replication rules. See "Frequency of data replication" on page 83. The replication system will dispatch XML documents to the URL you have specified on the intranet.

An CloudSuite Business site can communicate with an external site when it is on a different intranet, as shown in this example:

MyCORP (Internal) Intranet: SiteA SiteB (master site) SiteC

InforBUS Intranet (BOD-enabled applications): InforBUS site

Each of these external sites must be on its own intranet because each application uses a different URL address.

CloudSuite Business SiteB could perform transactional replication with all the internal sites, and could perform non-transactional replication to all the external sites.

Transport method

Most sites on external intranets use HTTP transport protocol to communicate with CloudSuite Business sites. However, Infor BOD-enabled applications use the ESB transport protocol.

Sending or receiving Business Object Documents from multiple sites on an intranet

Consider this information.

Purging BOD information

Information from every inbound BOD, including sequencing information, is collected in a table in the application. This data constantly builds up and, over time, could cause performance issues. For this

reason, system administrators should periodically use the Purge BOD Information form to purge information from that table. You can set up a background task to perform this function automatically. You can also use the Replication Document Inbox/Outbox Purge Utility to clear out older BODs from the Replication Document Inbox and Outbox.

See "Replication overview" on page 109 to get a general understanding about how replication works before you continue. Without that understanding, the replication planning steps probably will not make sense.

Considerations

Generally, the data that needs to be shared falls into one of the default replication categories - for example, Centralized Order Entry, G/L, or Inventory/Transfers. The default categories are described in the Background Information. These standard categories have been tested to ensure that they include all the necessary database tables, methods/stored procedures, and/or XML documents that must be included when replicating data for these areas of CloudSuite Business.

When you set up a multi-site system, you usually start by replicating the default categories between the sites where you think the information is required.

After your system is running, you might need to revise the rules, and possibly customize the categories, to achieve optimal performance based on your specific system's needs.

List the categories of data that need to be shared through replication, and the sites that need to share that type of data.

Does the data need to be shared in both directions?

Updating the flowchart

Update your flowchart with arrows indicating the categories of data being shared between the sites, and the directions the data is flowing.

See the sample flowchart in "Creating a flowchart that shows your hierarchy" on page 13.

Creating a ReplicationRules spreadsheet

Create a ReplicationRules spreadsheet listing each of the categories you think you will need, in each direction, from each site.

	A	B	C
1	Source Site	Target Site	Category
2	CAL	CAN	Site Admin
3	CAL	CRP	Ledger Consolidation
4	CAL	CRP	Site Admin
5	CAL	ILL	A/P
6	CAL	ILL	A/R
7	CAL	ILL	Centralized Order Entry
8	CAL	ILL	Inventory/Transfers
9	CAL	ILL	Site Admin
10	CAL	ONT	Centralized Order Entry
11	CAL	ONT	Inventory/Transfers
12	CAL	ONT	Site Admin
13	CAL	USA	Ledger Consolidation
14	CAL	USA	Site Admin

Background information

Use this information to better understand the concepts.

Replication with multiple sites per database

When you have multiple sites per database, tables are shared by the sites in that database. However, data is filtered by site. If you want a site to be aware of another site's specific data, you still must set up replication rules between the sites.



Default replication categories

The default replication categories included in CloudSuite Business are listed in the table below. More information about when to use each category is included in this section. See "Replication category tables" on page 117 for details about the stored procedures and tables that are included in each category.

If you choose to create new categories or modify existing ones, we strongly recommend that you get help from Infor Consulting Services. Determining all the relationships between tables and stored procedures is not a simple task. For example, the Centralized Order Entry category includes more than 90 tables and methods.

Note: Carefully consider which of the categories you actually need to replicate to each site. The more data being replicated, the slower the system's performance will be.

Some tables and objects exist in multiple categories; however, if you replicate these multiple categories to a site, only one set of table records is sent to the site.

Category	Create a source site-to-target site rule for this category in order to do this
A/P	View Accounts Payable posted transactions for the remote site Distribute A/P payments to remote site A/P posted transactions Include remote sites in A/P reports Share vendor addresses to the remote site
A/R	View Accounts Receivable posted transactions for the remote site Distribute A/R payments to remote site A/R posted transactions Include remote sites in A/R reports Share customer addresses to the remote site
CCI Centralized Order Entry	Use with the Centralized Order Entry category to support the use of the Credit Card Interface with centralized order entry.
Centralized Order Entry	Enter order lines to be shipped from the remote site Enable global item defaulting with the remote site View available inventory for the remote site Share customer addresses to the remote site
Customer Portal	Provide multi-site item pricing for Customer Portal and Reseller Portal. Allow the portal User Account Management Utility to create user accounts across sites
Dimensions	Share dimensions and attributes created at other sites. Site-specific information such as account numbers is not replicated.
ESB	Support the import and export of Business Object Documents (BODs) to and from Infor BOD-enabled applications.
EXTFIN	Support the export of A/P, A/R, Analytical Ledger, and Ledger posted transactions to an external financial application (the remote site is the site representing the external financial application).
	 Caution: This category should only be used in rules for transferring data to an external financial application.
EXTFIN Customer	Support the export of customer data to an external financial application (the remote site is the site representing the external financial application)
	 Caution: This category should only be used in rules for transferring data to an external financial application.

Category	Create a source site-to-target site rule for this category in order to do this
EXTFIN Vendor	<p>Support the export of vendor data to an external financial application (the remote site is the site representing the external financial application)</p> <div style="background-color: #e6f2e6; padding: 5px; border: 1px solid #ccc;">  Caution: This category should only be used in rules for transferring data to an external financial application. </div>
G/L	<p>Support multi-site G/L reporting of data for the remote site</p> <p>Perform financial reporting by site group</p> <p>Support site/entity relationships between the local site and the remote site</p>
Initialize _All Parameters	<p>Quickly select all parameter tables during multi-site replication setup. See the <i>Infor CloudSuite Business Multi-Site Implementation Guide</i> for more information.</p>
Inventory/ Transfers	<p>View available inventory for the remote site</p> <p>Support the setup of inter-site parameters between the local site and the remote site</p> <p>Enable multi-site transfer functionality with the remote site</p> <p>Enable global item defaulting with the remote site</p>
Invoice Builder	<p>Generate, print and post invoices for customer order shipments and returns in multiple target sites from a base site.</p>
Journal Builder	<p>Enter pending multi-site journal entries at the local site and validate the information from the remote site.</p>
Ledger Consolidation	<p>Pass G/L data needed only for ledger consolidation. This is a subset of the G/L category that does not include journal and ledger tables; if you are already replicating the G/L category, do not replicate this one.</p> <p>Support site/entity relationships between the local site and the remote site</p>
Ledger Detail	<p>Support viewing ledger detail for transaction data stored at the remote site.</p>
Manufacturer Item	<p>View manufacturer item information that was created in another site.</p> <p>View another site's cross-reference information between manufacturer item records and CloudSuite Business item records.</p>
Multi-Site BOM Builder	<p>Use with the Multi-Site BOM Builder form, to support the copy of item BOMs from one site to other sites.</p>
Multi-Site Buyer	<p>Support multi-site information on the Buyer Home form.</p>
Multi-Site Controller	<p>Support multi-site information on the Controller Home form.</p>
Multi-Site CRM	<p>Support multi-Site CRM information on the Salesperson Home form.</p>
Multi-Site Customer Service	<p>Support multi-site information on the Customer Service Home form.</p>

Category	Create a source site-to-target site rule for this category in order to do this
Multi-Site Customers	Support use of the Multi-Site Customers form from a master site.
Multi-Site Inventory Control	Support multi-site information on the Inventory Control Home form.
Multi-Site Items	Support use of the Multi-Site Items form from a master site.
Multi-Site Production Planner	Support multi-site information on the Production Planner Home form.
Multi-Site Project Manager	Support multi-site information on the Project Manager Home form.
Planning	Pass Planned Supply created by the (single-site) Planner to the supply site as planned transfer demand - for items flagged as Transferred and containing a Supply Site View planning requirements and receipts for remote sites.
PO - CO Across Sites	Support the ability for demand from one site to be satisfied by another site in a purchase order-customer order relationship.
Purchase Order Builder	Enter builder purchase orders at the local site and validate the information from the remote site.
Service - Global Incidents	Ensure that incidents that are updated in one site are synchronized to another site.
Service - Global Scheduling Shared Partners	Replicate tables related to both appointments and partners.
Service - Global Service History	View service information from multiple sites together on the Service Console.
Service - Global Units	Ensure that units that are updated in one site are synchronized to another site.
Service - Multi-Site SRO Copy	Cross-reference lines, operations, reasons, and planned transactions of the specified service order from one site to another and create a new service order in another site.
Shared Currency	Share currency and currency rate data with the remote site.
Site Admin	Support setup of inter-site parameters Share site/entity data, including intranet data and site group data, with the remote site.
Vendor Portal	Allow the portal User Account Management Utility to create user accounts across sites.
Voucher Builder	Create vouchers and adjustments in other sites based on information from those sites.

Replicating Site Admin

Replicating the Site Admin category between sites/entities allows them to share information about linked sites/entities, intranets, and system types. This should be the first category you replicate once you set up your multi-site system.

We recommend that, if you are replicating any data between CloudSuite Business databases, you always include a rule to replicate the Site Admin category. This applies to both entity and site databases, and the rules should be written to replicate the Site Admin data in both directions.

This flow chart shows an example:

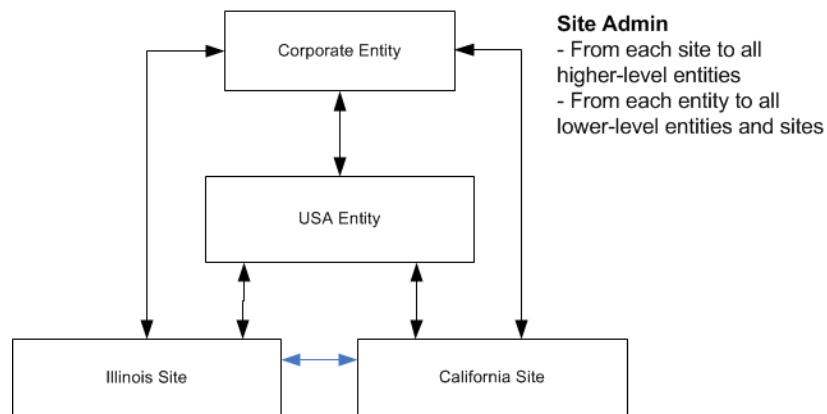

Replicating A/P and A/R

The A/P and A/R categories are generally replicated between sites. These categories allow you to handle the payment of an invoice or voucher from another site, and to centralize cash applications. You can also view A/P or A/R posted transaction details for multiple sites.

You will need to specify liability and asset accounts for inter-site payments on the **Payment** Tab of the Inter-Site Parameters form.

This flow chart shows an example:

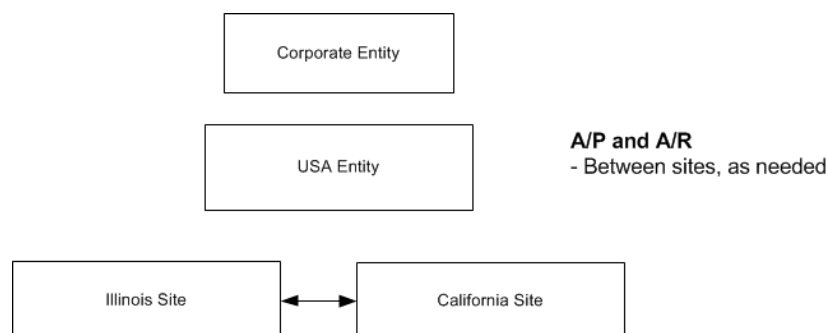

Replicating multi-site information for Home forms

These categories allow you to view related information from other sites in the appropriate Home form:

- Multi-Site Buyer
- Multi-Site Controller
- Multi-Site CRM (Salesperson Home)
- Multi-Site Customer Service
- Multi-Site Inventory Control
- Multi-Site Production Planner
- Multi-Site Project Manager

Replicating Manufacturer Item

The Manufacturer Item category is generally replicated between sites. Manufacturer item records contain cross-referenced information about your CloudSuite Business items and various manufacturers' items. This category allows you to view the source site's information at a target site.

Replicating Centralized Order Entry and Inventory/Transfers

The Centralized Order Entry and Inventory/Transfers categories are generally replicated between sites. For a better understanding of how the Centralized Order Entry and Inventory/Transfers categories may be used, see "Centralized and decentralized order entry" on page 44.

For these categories, you must specify some intra-entity and inter-entity account numbers on the Inter-Site Parameters form.

When you replicate A/R or Centralized Order Entry, the custaddr_mst table is replicated. Thus, when a user in the Customers form at any site updates certain customer information such as the billing address, the change is made for that customer at all other sites. You may want to set up CloudSuite Business authorizations to limit the users who can modify customer information. The same thing is true for the A/P category and the vendaddr_mst table.

Replicating credit card information

If you have a multi-site system with centralized order entry and the Credit Card Interface is available, your users can enter and validate credit card information from a centralized site, and then later charge the card from a different shipping site where the invoice is generated. Be aware of these rules:

- This feature does not apply to service orders, only to customer orders

- Your company must have a single merchant account that is used by all of your sites. Therefore, the gateway access and other settings in the CCI Parameters form must be the same in every site.
- Stored credit card information is not replicated. It is stored only at the order entry site.

To turn on this feature, use these steps:

- 1** Ensure that replication rules are created that include both of these replication categories:
 - Centralized Order Entry
 - CCI Centralized Order Entry
- 2** On the Replication Rules form, set up the shipping sites as target sites that receive both rules from the centralized order entry (source) site, and regenerate the replication rules at all sites.
- 3** When a user clicks **Pay with Credit Card** during order entry, if a successful authorization is received, the system replicates that authorization information to each of the sites that are set up to receive this replication category.

Sharing vendors, customers, or items between sites

You might want an administrator to control adding, updating, and deleting of shared customers, vendors, and items across the system. Keep in mind that each site can control its local customer and vendor records, and these records are independent of other sites.

Shared vendors

If you have a master site, use the Multi-Site Vendors form at the master site to add and update multi-site vendor records for all sites on the intranet. The A/P, Ledger Consolidation (or G/L) and Inventory/Transfers categories must be replicating in order to use this form.

If no master site is required, but if A/P replication is set up between sites, some vendor data is replicated to other sites when a new vendor is added at one site. The new record does not automatically appear in the Vendors form at the other sites. However, the new vendor number does appear in the drop-down list when you start to add a new vendor at the other sites - so you can select it and add a new record for it. This ensures that the vendor number is the same at all sites.

Any changes made to the vendaddr records in one site are automatically replicated if the vendor number exists in the other site and the A/P category is replicated. Note that the vendaddr_mst table contains other information in addition to the vendor's address.

The currency code cannot be changed for a vendor after the record is saved. However, an additional vendor record can be added with the new currency code.

Shared customers

If you have a master site, use the Multi-Site Customers form at the master site to add and update multi-site customer records for all sites on the intranet. The Site Admin and Multi-Site Customers categories must be replicating in order to use this form.

If no master site is required, but if A/R or Centralized Order Entry replication is set up between sites, some customer data is replicated to other sites when a new customer is added at one site. The new

record does not automatically appear in the Customers form at the other sites. However, the new customer number does appear in the drop-down list when you start to add a new customer at the other sites - so you can select it and add a new record for it. This ensures that the customer number is the same at all sites.

Any changes made to the custaddr records in one site are automatically replicated if the customer number exists in the other site and the A/R or COE category is replicated. Note that the custaddr_mst table contains the customer's credit information as well as the address and other information.

The currency code cannot be changed for a customer after the record is saved. However, you can specify additional currencies for the customer, to be used with specific transactions.

Using Credit Hold in a Multi-Site Environment

In a multi-site environment, the originating site of a customer order controls the credit hold status of the customer order for all sites from which the customer order may be shipped. Also, when you initiate the Order Credit Hold Change Utility in a multi-site environment, the system performs the processing at all sites for the selected customers.

CloudSuite Business checks the customer's credit limit to determine if it is exceeded to determine whether to use credit hold:

- If a customer's credit limit is exceeded and the shipping site is the originating site of the customer order, the order is placed on credit hold.
- If a customer's credit limit is exceeded and the shipping site is not the originating site of the customer order, a warning message displays, but the customer order is not placed on credit hold.

Shared items

If you have a master site, use the Multi-Site Items form at the master site to add and update multi-site item records for all sites on the intranet. The Site Admin and Multi-Site Items category must be replicating between the sites in order to use this form.

If no master site is required, and Inventory/Transfers replication is set up between sites, some item data is replicated to other sites when a new item is added at one site. This data appears in the Global Items form. The Global Items form also contains a default Shipping Site, which is used to determine how the Customer Order Line ship site defaults when entering a centralized order for the item. Typically, replicating sites have identical Global Items default values when all sites are within the same country. If sites are in different countries, the **Description** and **U/M** fields can be updated as required on Items records.

The new record does not automatically appear in the Items form at the other sites. However, the new item number does appear in the drop-down list when you start to add a new item at the other sites - so you can select it and add a new record for it. This ensures that the item number is the same at all sites.

Coordinating units of measure at different sites

Item units of measure (U/M) are handled differently for customer order entry and transfer orders:

- Transfer Orders: Items on transfer orders must have identical U/Ms at all sites.

- Order Entry: It is not necessary to have the same U/M defined at different sites, as long as the shipping site has defined a U/M conversion between the item's base U/M and the U/M used in the order line.

If an item could be both sold on a customer order and transferred between sites, then the item must have identical units of measure at each site.

Replicating item routing and BOM information

Use the Multi-Site Bill of Material Builder utility and the Multi-Site BOM Builder replication category to copy an item's bill of materials from a site to other sites. The Builder copies a single level at a time. For more information, see the help on copying a multi-site item bill of materials.

Replicating financial information

Use the information in this section to decide when to replicate these categories:

- G/L
- Ledger Detail
- Ledger Consolidation

Note: Be aware that replicating the G/L and Ledger Detail categories can create thousands of (possibly unnecessary) records at the target site and can send large amounts of data over your intranet, affecting system performance.

From entities to child entities or sites

Ledger Consolidation is a subset of the G/L category. In order to push Chart of Accounts, Accounting Periods, and Budget/Plan data from the entity to its child sites, you must replicate either the G/L or Ledger Consolidation category. Generally you should use the Ledger Consolidation category when replicating from an entity to another entity or to a site, because you do not need to view the entity's journal or ledger information at the other entity/site. Less data is transmitted between the systems, which results in better system performance.

This flow chart shows an example of Ledger Consolidation replication:

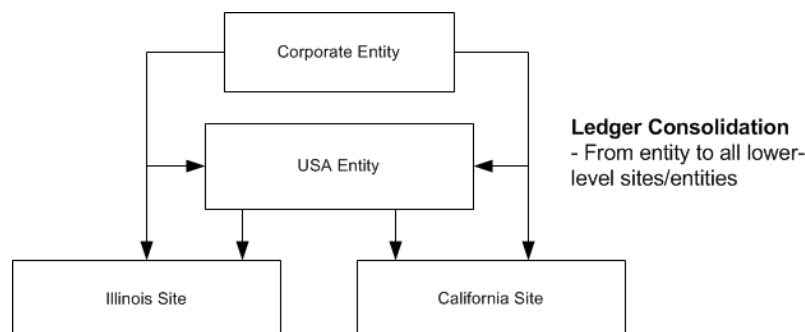

From child sites or entities to a parent entity

Financial statements require balance information, which is calculated using data from the ledger. So if you want to run a financial statement at an entity that includes data from another entity or site, consider this:

- When you run a financial statement at the entity and specify a Site Group, the entity looks at replicated data, so you would need to use the G/L category when replicating from child sites/entities to this entity.
- When you run a financial statement at the entity and leave the Site Group blank, the entity looks at the consolidated records created via the Ledger Consolidation utility. (When you use the Ledger Consolidation utility to consolidate information from a site to an entity, the utility copies the ledger table to the parent entities, altering the hierarchy column to reflect the Entity path from the Site, converting amounts to the Entities' currency, and possibly creating new ledger transactions to reflect currency rounding differences.) So if you never specify a Site Group at the entity, use the Ledger Consolidation category when replicating from sites/child entities to this entity.
- If you sometimes specify a Site Group and sometimes do not, use the G/L category when replicating from child sites/entities to this entity. That way the data will be available at the entity when you need it.

If you need to "drill down" to view a site's transaction details at the remote site, then replicate the Ledger Detail category as well as the G/L category. This assumes that any other categories required for the transaction-level detail are also being replicated; for example, viewing detail for invoice transactions may also require replication of the A/R or Centralized Order Entry categories. It may be better (from a performance standpoint) to just log into the site where the transaction occurred and view the detail there.

If you will perform Budget Consolidation, either Ledger Consolidation or G/L replication is required from sites to the parent entities, as shown in this flow chart:

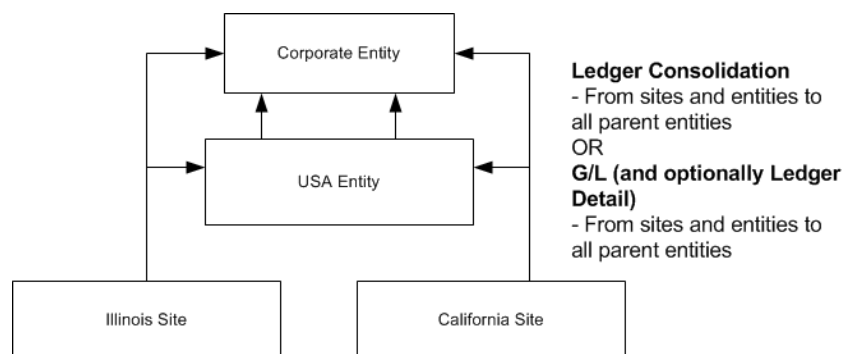

Using the Change Reports To Entity utility

The Change Reports To data is replicated in the G/L or Ledger Consolidation categories, and the **Reports To** field is replicated in the Site Admin category. Set up replication so that your highest-level entity displays **Reports To** information in the Sites/Entities form for all sites and lower-level entities.

Between sites

General ledger data rarely should be replicated between two non-entity sites.

Unit codes

The `unitcd[1-4]_mst_all` and `chart_unitcd[1-4]_mst_all` tables are replicated in the G/L category. The Ledger Consolidation replication category contains a stored procedure that inserts information into the `unitcd[1-4]_mst` tables based on the unit codes within ledger rows that are consolidated. (Unit code information is included when you run the Ledger Consolidation utility.)

The `unitcd[1-4]_mst_all` table is included in other financial replication categories such as A/P, A/R, Journal Builder, and Purchase Order Builder.

The Inventory/Transfers category also includes `unitcd[1-4]_mst_all` and `chart_unitcd[1-4]_mst_all` tables. This allows visibility of unit codes from remote sites on the Inter-Site Parameters form.

Replicating dimensions

Replicate the Dimensions category if you want users to view dimensions and attributes that were created at other sites. Because the replicated tables are not `_all` tables, this data is being "shared" between the source and target sites. If updates are made at the source site, these updates are made to the tables in target sites.

Site-specific information such as account numbers is not replicated. For more information about dimensions and attributes, see the online help.

Replicating shared currency

Depending on how your system handles currencies between sites, the Shared Currency replication category can be used to permit sites and entities to share currency definitions and exchange rates; otherwise, each site maintains its own currency codes and rates.

The domestic currency must be the same at all sites reporting to an entity. However, you may set up the sites so they can maintain their own currency exchange rates - or you may want to maintain the exchange rates only at the entity:

- If currency and rate maintenance is performed only at the entity, you should replicate the Shared Currency from the entity down to the reporting sites. You do not need to replicate the Shared Currency category up from the sites to the entity. You must then disable the ability to change Currency Rates at the sites, in order to maintain control over the data. This flow chart shows an example of this option:

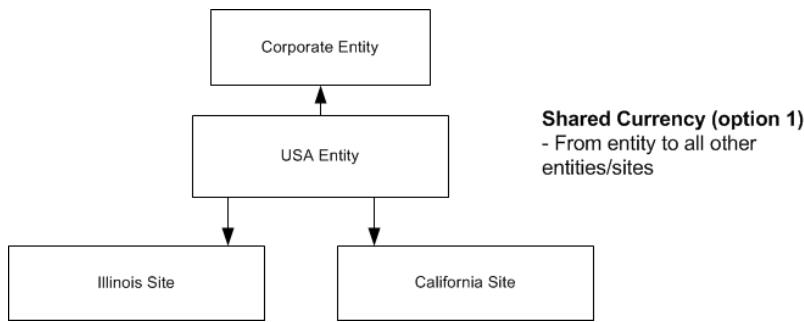

- If currency and rate maintenance is performed at sites, then you should replicate the Shared Currency category from the sites up to the entity to which the sites report (and not back down to the sites from the entity). When using this setup, sites within the same reporting structure should also replicate currency and rate information between the sites. This flow chart shows an example of this option:

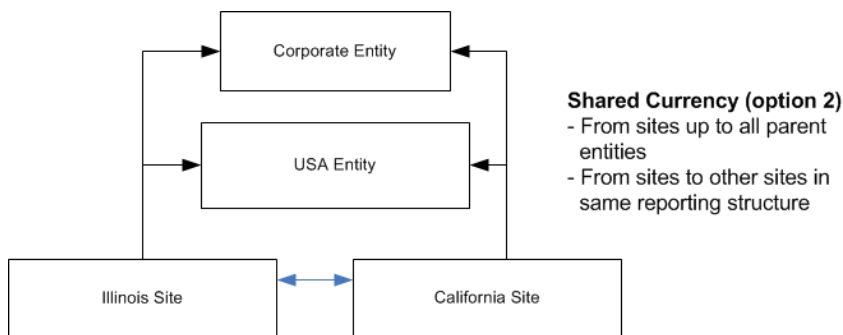

Although this category replicates base tables, updates to the tables at one site/entity are only replicated to other sites/entities if there is a replication rule between them. (Replication is point-to-point.)

You could also set up your system to have only one site maintaining the currency codes, in which case you would have one-way replication rules from that site to all other sites and entities.

Replicating planned transfer orders (Planning)

The MRP and APS systems generate planned transfer supply orders (PLNs) for any components provided by remote supply sites. The due date on these PLNs will be based on each item's lead time and transit time. To generate the corresponding planned transfer demand, or TPLN, at the supply site (that is, for the supply site to "see" this demand), you must set up the system to replicate the planned transfer order to the supply site.

In the Replication Rules form, you define the receiving site and supply site for replicating the transfer orders:

- The Source Site must be the receiving site (the site where the demand originates).

- The Target Site must be the supply site that produces the component. This should be the same site defined as the Supply Site on the item record. The planned transfer order will be replicated at this site.

Additional notes:

- Multiple planned transfer demands are consolidated before being replicated to the supply site.
- When you replicate the Inventory/Transfers category, supply and demand transfer orders are synchronized; that is, a demand transaction at one site precedes the related supply transaction at the other site. However, if you also replicate the Planning category, planned transfer orders do not need to wait for a transfer order transaction from the other site, as demonstrated by this example:
You run planning (either MRP or APS) at the receiving site. At the supply site, the planned transfer demand (TPLN) is automatically generated, with an XFD reference, as soon as it arrives – without having to firm a transfer order. In this way, the receiving site has immediate visibility of the TPLN ahead of the true Transfer Order. (With APS, the TPLN is incrementally planned.) The resulting projected date for the order is not replicated back to the receiving site that generated the demand. At the receiving site, when you firm the planned transfer supply order into an actual transfer order, the system replicates that transfer order to the supply site and deletes the TPLN.
- The due date on a planned transfer order reflects transit time.
- Sites running MRP Planning can replicate transfer orders to sites running APS Planning. Sites running APS Planning (in single-site mode) can replicate transfer orders to sites running MRP Planning. However, sites running APS Planning in Global mode cannot replicate transfer orders to MRP sites.

This flow chart shows an example of Planned Transfer replication:

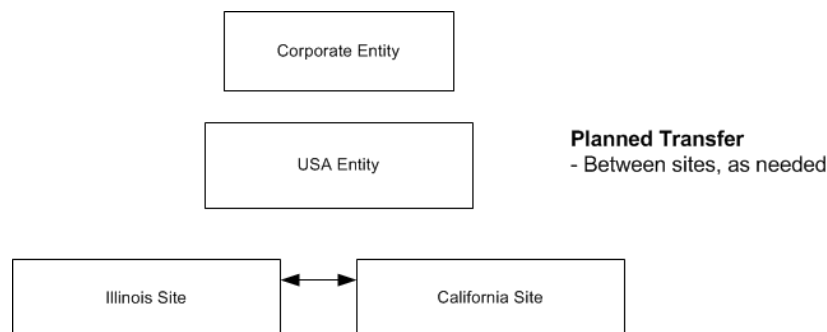

Replicating external financial (EXTFIN) data

CloudSuite Business provides an XML-based interface that can be used with an external financial system such as SAP.

Note: The EXTFIN interface is not the same as the Infor CloudSuite Business Enterprise Financials interface, which interfaces with SunSystems and which uses a custom set of replication categories. For more information about this interface, see "Enterprise Financials (SLSI)". EXTFIN is also not the same as the Infor Global Financials (IGF) interface, which uses direct data access.

You can choose the types of financial information to export or import between CloudSuite Business and the other system. These are the default External Financial categories:

- **EXTFIN:** Used for exporting CloudSuite Business A/R, A/P, and G/L transactions to the external financial system, and also for exporting requests for updates to CloudSuite Business tables by the external financial system. This category includes the functions and XML documents required to export financial information:
 - **ExtFinAPVoucherPosting:** Exports data from the CloudSuite Business `export_aptrx_mst` and `export_aptrxd_mst` tables, which are holding tables for data collected from various A/P tables.
 - **ExtFinARInvoicePosting:** Exports data from the CloudSuite Business `export_arinv_mst` and `export_arinvd_mst` tables, which are holding tables for data collected from various A/R tables.
 - **ExtFinAnaLedgerPosting:** Exports data from the CloudSuite Business `ana_ledger_mst` table.
 - **ExtFinLedgerPosting:** exports data from the CloudSuite Business `ledger_mst` table.
 - **ExtFinRequest...:** Exports a request to the external financial application for updates to a specific CloudSuite Business table. See the help on the External Financial Interface Data Request Utility for more information
- **EXTFIN Customer:** Used for exporting CloudSuite Business Customer information. This category includes the sibling database tables `custaddr_mst` and `customer_mst`.
- **EXTFIN Vendor:** Used for exporting CloudSuite Business Vendor information. This category includes the sibling database tables `vendaddr_mst` and `vendor_mst`.

Rules that contain EXTFIN, EXTFIN Customer, or EXTFIN Vendor should be set up only where the "To" Site is a site that represents an external application.

When a new customer or vendor record is added in CloudSuite Business, the information is sent to the external financial system as two XML documents: one XML that contains new `customer_mst` or `vendor_mst` data but only key values for `custaddr_mst` or `vendaddr_mst` table records, and another XML document that contains new and old values for updated `custaddr_mst` and `vendaddr_mst` table records. For updates to existing customer or vendor records, the XML document pulls records only from the table that changed.

Initializing parameter table data

The Initialize _All Parameters category is only used with the Update _All Tables form, to simplify the selection of the parameter tables during replication setup. For more information about how to use this category, see the information about setting up replication in the *Infor CloudSuite Business Multi-Site Implementation Guide*.

Replicating Invoice Builder data

If you plan to use the Invoice Builder form to create invoices at other sites, set up these replication rules for the Invoice Builder category:

- From the site running the Invoice Builder to remote sites into which invoices will be inserted. This allows the creation of the invoices in the remote sites.
- From the remote sites to the Invoice Builder site. This replicates the necessary _all table data for validations performed on the Invoice Builder form.

In the Customer Order Lines and Customer Order Blanket Lines forms, users can specify a ship site. The item is shipped from this site even if the order is created at another site. Normally, the invoice is created at the ship site. For example, an order is created at the OH site, with two lines for Item X and Item Y. For item X, the ship site is OH, and for Item Y, the ship site is IN. The invoice for Item X is created in the OH site, and the invoice for Item Y is created in the IN site. However, if you have Invoice Builder replication set up, invoice creation and posting can all be done at the OH site, through the Multi-Site Invoice Posting form.

If you use the Invoice Builder, be aware of these requirements:

- In the target sites and the site where the Invoice Builder is being run, this information must match: base (domestic) currency, currency and quantity formats, cost/price formats, tax systems, and terms code tables.
- The same customers, customer addresses, and customer currency must be used at the Invoice Builder site and at the target sites.

Replicating Journal Builder data

If you plan to use the Journal Builder form to enter multi-site journal entries that will be created in other sites, set up these rules for the Journal Builder category:

- From the site running the Journal Builder to remote sites into which pending journal transactions will be inserted. This rule allows the processing of the pending journal transactions to the remote sites.
- From the remote sites to the Journal Builder site. This replicates the necessary _all table data for validations performed on the Journal Builder form.

Journal Builder use at an entity, or to enter transactions to be inserted at an entity, is not supported.

In the Journal Builder, transactions can be entered only for sites that use the same domestic currency as the local Journal Builder site.

Replicating Purchase Order Builder data

If you plan to use the Purchase Order Builder form to create purchase orders at other sites, set up these replication rules for Purchase Order Builder:

- From the site running the Purchase Order Builder to remote sites into which purchase orders will be inserted. This allows the creation of the POs in the remote sites.
- From the remote sites to the Purchase Order Builder site. This replicates the necessary _all table data for validations performed on the Purchase Order Builder form and for printing the Builder purchase order.

Be aware of these setup requirements for the Purchase Order Builder:

- These characteristics must match in the target sites and the site where the Purchase Order Builder is being run: base currency, currency and quantity formats, terms code table, tax system setup, tax parameter setup, tax codes assigned to vendors, and tax codes assigned to items.
- On each purchase order related to the same Builder PO, the system assumes that the same terms code, buyer, Remit To address, vendor contact, and LCR number are used.
- Vendors must be set up to use the same currency in both target and PO Builder sites.
- The target sites must have the same U/M Conversion factors as the PO Builder site.
- Transactional replication is required.

Replicating Voucher Builder data

If you plan to use the Voucher Builder form to create vouchers and adjustments at other sites, set up these replication rules for the Voucher Builder category:

- From the site running the Voucher Builder to remote sites into which vouchers and/or adjustments will be inserted. This allows the creation of the vouchers and/or adjustments in the remote sites.
- From the remote sites to the Voucher Builder site. This replicates the necessary _all table data for validations performed on the Voucher Builder form.

If you plan to use the Manual Voucher Builder form to create a voucher in one or more sites for a single vendor's invoice, set up these replication rules for the Voucher Builder category:

- From the Manual Voucher Builder site to the remote sites into which pending voucher transactions will be created. This allows the setup of how the system will process pending voucher transactions.
- From the remote sites into which pending voucher transactions will be created to the Manual Voucher Builder site. This replicates the necessary _all table data for validations performed on the Manual Voucher Builder form.

Be aware of these setup requirements for the Voucher Builder:

- These characteristics must match in the target sites and the site where the Voucher Builder is being run: base (domestic) currency, currency and quantity formats, cost/price formats, tax systems, and terms code tables.
- The system requires that the same vendors, vendor addresses, and vendor currency are used at the Builder Voucher site and at the target sites.

Be aware of these setup requirements for the Manual Voucher Builder:

- These characteristics must match in the target sites and the site where the Manual Voucher Builder is being run: base (domestic) currency and currency formats.
- The system requires that the same vendors, vendor addresses, and vendor currency are used at the Builder Voucher site and at the target sites.

Replicating Customer and Vendor Portal data

All sites in the portal site group must be linked and replicated using standard replication rules. For the Vendor Portal, the A/P replication category must be replicated across all sites in the Vendor Portal site group. For the Customer Portal and Reseller Portal, the A/R, Centralized Order Entry, and Customer Portal replication categories must be replicated across all sites in the Customer Portal site group.

For more information about setting up multi-site portals, see "Portals" on page 97.

Replicating Service data

These replication categories are used with CloudSuite Business Service:

- Service - Multi-Site SRO Copy
- Service - Global Incidents
- Service - Global Service History
- Service - Global Units
- Service - Global Scheduling of Shared Partners

Incidents and units

Both the Service - Global Incidents and Service - Global Units categories allow you to set up replication rules so that incidents and units that are updated in one database are synchronized to another database. When you create a replication rule for either category, set the **Interval Type** to **Transactional**.

Note: Because customer information is included on an incident, the A/R replication category must also be replicated whenever incident replication is taking place.

Incident Reason and Resolution notes are replicated with the Service - Global Incidents category. Incident notes are not replicated.

Service Console

Use the Service - Global Service History category to set up replication rules so that service information from multiple sites can be viewed together on the Service Console form. The replicated data is read-only, so system performance and business processes should determine the replication interval setting.

Service orders

The Service - Multi-Site SRO Copy category is used with the Multi-Site Service Order Copy form, which copies all lines, operations, reasons, and planned transactions of the specified SRO from one site to another. Set the replication rule interval to Transactional.

Note: The service order copy utility only works between live-linked sites on the same SQL database server.

Global scheduling of shared partners

Global scheduling of shared partners can be performed by companies that have multiple back office sites but one pool of technicians (partners) who perform service work for all sites. The Service - Global Scheduling Shared Partners replication category replicates tables related to both appointments and partners. The replication rule interval should be set to Transactional.

The appointment reference is not replicated. If your company requires cross-site access to the appointment reference, you should implement scheduling by incidents and configure the system for global incidents.

The warehouse, department, work code, and misc code are not included in this replication category, because these values are optional (not required) for partner setup. If your company populates this information on the partner, you must ensure that the data exists in both sites. To do this, either implement manual data entry processes or leverage standard replication by creating a custom replication category that includes the tables to replicate.

Replicating data via BODs (ESB)

CloudSuite Business provides an XML-based interface that can be used to transmit data to and from other Infor BOD-enabled applications. This interface must be set up as described in the appropriate application's integration guide.

Rules containing the ESB replication category should be used only where the "To" Site is a site that represents BOD integration.

Recommended transactional replication rules

Infor Consulting recommends some standard rules for companies that use transactional replication.

Transactional replication and Update All Columns are explained in "Frequency of data replication" on page 83."

This table lists the recommended rules for entities:

Replication Category	To	Interval Type	Update All Columns
Site Admin	All Sites All Entities	Transactional	No
Ledger Consolidation **	Child Sites/Entities	Transactional	No
Shared Currency *	Child Sites/Entities	Transactional	No

This table lists the recommended rules for sites:

Sharing data between sites

Replication Category	To	Interval Type	Update All Columns
Site Admin	All Sites All Entities	Transactional	No
G/L or Ledger Consolidation **	Sites/Entities	Transactional	No
All Others (A/P, A/R, Central- ized Order Entry, Invento- ry/Transfers) as needed	Sibling Sites	Transactional	No

** See "Replicating financial information" on page 66 for your options.

* See "Replicating shared currency" on page 68 for your options.

See "Replication overview" on page 109 to get a general understanding about how replication works before you continue. Without that understanding, the replication planning steps probably will not make sense.

Considerations

You might decide to set up master sites and shared views into tables at the master site, instead of replicating tables, for some areas of your system.

If all your sites are in a single database, you are effectively sharing many database tables already. However, we recommend that you set a master site for the intranet, in order to maintain customers, vendors, and items for all sites from the master site. You can optionally use the Intranet Shared User Tables form to share the Authorizations_mst, UserGroupMap_mst, and/or user_local_mst tables if you want to share users and group authorizations information between sites. You should not use the Intranet Shared Tables form; those tables are already shared because the sites are all in one database.

Advantages of using a master site

If you use a master site for certain functions, you have these advantages:

- Establish central global tables, many of which allow filtering by site
- Require less storage space – fewer records are replicated across the enterprise
- Use less background processing
- Simplify replication troubleshooting and querying of _all tables
- Provide a lighter load on database servers, thus better speed for end users.
- Centralize entry of customer, vendor and item records
- Centralize maintenance of user and group information.

Updating the flowchart

Update your flowchart with boxes for any master sites. These boxes should indicate somehow - through shading or color, perhaps - that they are master sites.

Indicate shared data that resides at the master site - either by replication category or by table name. Use a different type of arrow, perhaps thicker or a different color.

This flow chart shows an example with a master site:

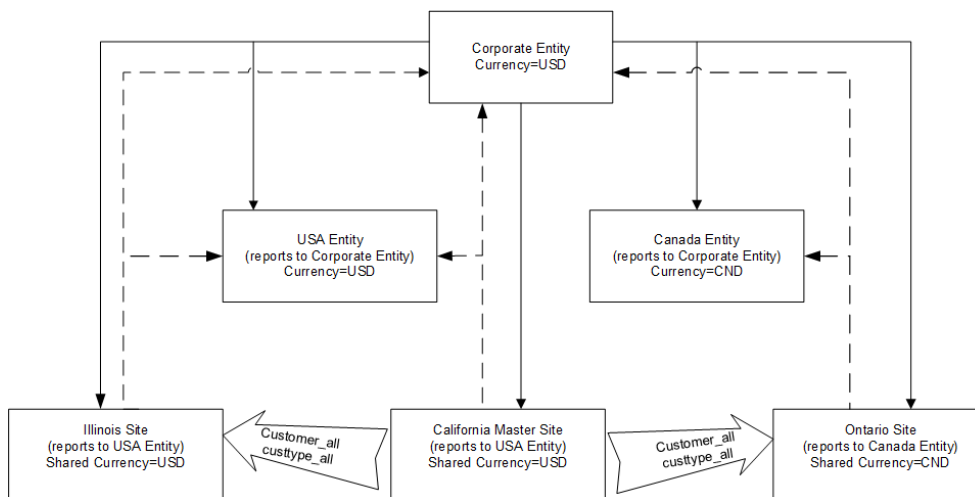

Remember that all of the sites in the same application database must share tables in the same way. You cannot share a table in one site in database A without sharing the table for all sites in database A.

Creating a list of the tables or categories controlled by the master site

For future reference when setting up the Intranet Shared Tables form, create a list of the shared tables (or the replication categories) controlled by each master site.

Updating the SiteEntity spreadsheet

Update the SiteEntity spreadsheet to indicate any sites that are master sites. You could do this either by adding a Master Site column or by adding "Master Site" to the description.

Updating the ReplicationRules spreadsheet

If you plan to add and maintain customers and vendors at your master site, be sure A/P, A/R, Ledger Consolidation (or G/L), and Inventory/Transfer categories are replicating between all sites on the intranet.

All sites on the master site's intranet must be replicating the SiteAdmin category, in order to recognize the master site.

Background information

Use this information to better understand the concepts.

Intranets with shared tables and master sites

On the Intranets form, you can specify a master site for an intranet. Master sites are CloudSuite Business sites that control some data for all other sites on an intranet. For example, master sites control any shared _all tables or shared user tables.

An intranet defined as "External" (containing non-CloudSuite Business sites) cannot have a master site defined for it.

You cannot delete an intranet that contains shared tables.

Shared user tables

At the master site, use the Intranet Shared User Tables form to share the user maintenance tables so they reside only at the master site for this intranet.

If multiple sites that belong to the same intranet are not in the same application database, then Intranet Licensing must be set up at the master site and all participating sites before you share user tables for the sites. This requirement is not applicable when all of the sites are in a single database.

The tables are removed from all sites on the intranet except the master site. SQL views to the table on the master site are created at each using or "slave" site. The other sites can add, update, and delete records through the views.

You can also unshare shared tables from this form. The views at the using sites are dropped, and the user tables are rebuilt at each of the using sites on the intranet.

Frequently asked questions about shared tables and master sites

Q: When would I want to set up a master site?

A: We recommend that you set up a master site even if you do not plan to share any tables at this time. (The only exception might be if you have only one or two sites to maintain.)

Master sites currently allow you to centralize entry of customers, items and vendors and to centralize maintenance of users.

Q: Why would I want to set up shared user tables?

A: It allows one administrator to maintain one set of users and user permissions in the master site that are applicable to all of the using sites on the intranet. This information is included:

- User information
This can include application-specific data such as user initials, multi-site group, etc.
- Groups information, including user-group assignments, user-group authorizations, and user-license module assignments.

You also have the option to exclude the AccountAuthorizations_mst, UserGroupMap_mst, and/or user_local_mst tables when you share user tables. This allows administrators to maintain users and most user settings in the master site, but apply different permissions for those users in each of the sites. Or you can maintain authorization groups globally (so they are the same for all sites), but maintain the user groups locally, so users can be assigned to different permission groups at different sites within an intranet.

Q: Can I set up some tables to reside only at the master site, and other tables to be replicated at all sites?

No, for user tables.

Q: Which tables does it make most sense to maintain at a master site rather than replicating?

A: This depends on your data, and the parts of the system you use the most.

Q: Which tables can only be maintained from a master site?

A: You can maintain data at any site (slave or master site).

At the master site, special forms are available for maintaining data about multi-site vendors, customers, and items. You can still maintain this information for specific sites from those sites. But from the master site, you can maintain vendor, customer, and item data for all the sites on the intranet.

Q: Can I set up a master site any time, or just when setting up the application initially?

A: At any time.

Q: Can I change the master site after it is set up?

A: Yes. Some of the user tables at the slave sites have been dropped and would have to be rebuilt, and the data that resides only in the master site's tables would have to be reloaded into the rebuilt tables. You can do this in the Intranet Shared User Tables forms.

If you remove a master site, these features that depend on a master site will no longer be available:

- Multi-Site Vendors form

- Multi-Site Customers form
- Multi-Site Items form

Q: Why would I use a master site if all of my sites are in a single database?

A: The Multi-Site Customers, Multi-Site Items, and Multi-Site Vendors forms can only be used from a master site.

Since all sites are in the same database, most user tables are shared across all sites even without a master site and without setting up Intranet Shared User Tables. However, you can share these user tables only if a master site is defined, through the Intranet Shared User Tables form:

AccountAuthorizations_mst, UserGroupMap_mst, user_local_mst.

Q: Can I add a new site to an existing intranet that has shared tables?

A: Yes. Contact your Infor representative.

Q: What happens to users at the other sites if the master site goes down for an extended period?

A: All sites on the intranet that link to the master site will not be able to access/update the tables that are only on the master site.

Q: Will my site see data from all other sites on the intranet when we share a table?

A: If the dropdown list in a form is based on an “_all” table, and if you are in a using site where that _all table is actually a view, then it will access that view.

If you share user tables, an administrator at any site on the intranet can see and update data for all users and groups, if the administrators have the appropriate permissions. If you originally share user tables and then change to per-site user tables, the user and group information for all users on the intranet is loaded into the tables at each non-master site.

Q: Can I use the master site to copy records from one site to multiple other sites?

A: You can use the Multi-Site Customers, Multi-Site Vendors, and Multi-Site Items forms to copy records to multiple other sites in the same intranet as the master site. The other sites must be in the same multi-site group as the master site. Item BOMs are not copied with item records when you use this method.

Maintaining customer, vendor or item data for other sites in the intranet

Special forms are available only at the master site that allow you to add and maintain some vendor, customer or item data for other sites on that intranet. This section shows examples for vendor data.

Vendor data includes the vendor_mst_all table/view (storing information that is not typically shared among sites), as well as the vendaddr_mst tables (storing information that is shared among all sites). The vendaddr_mst base table is replicated directly from the base table in the source site to the base table in the target site. In a master site scenario, vendor_mst_all is a view at the sharing sites (assuming that vendor_mst_all is set up as a shared table), but vendaddr_mst is an actual table that contains the same data at the master site and all sharing sites.

Sharing some data through master sites

An example process to add and update vendor data between the master site and sharing sites is shown in this flow chart:

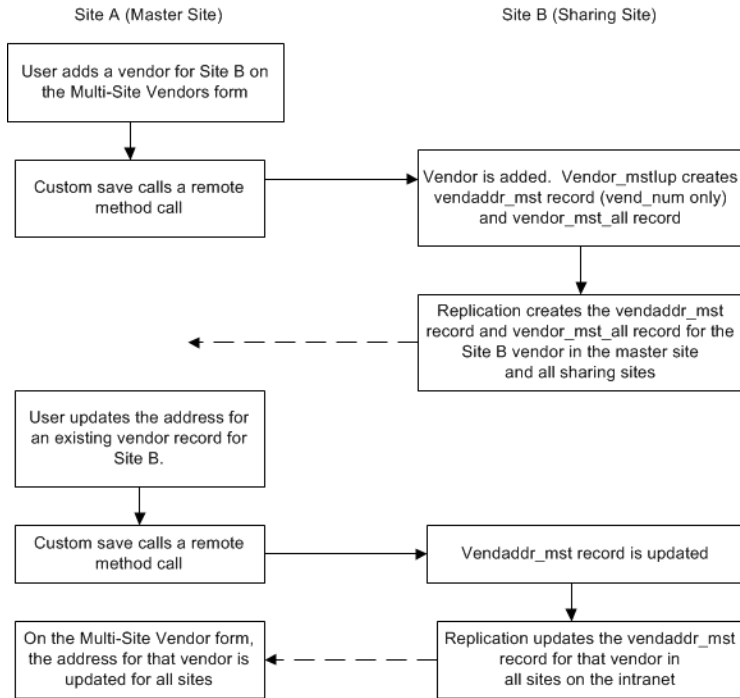

Frequency of data replication

See "Replication overview" on page 109 to get a general understanding about how replication works before you continue. Without that understanding, the replication planning steps probably will not make sense.

Consider this information:

- You can use transactional or non-transactional replication between your sites, or a combination of both.
In a cloud environment, non-transactional replication is generally only used for the INFORBUS site and is preconfigured by the Infor Cloud team.
- Replication rules specify when and where to replicate the categories of data you chose earlier.

Update the ReplicationRules spreadsheet

Indicate which of your rules are transactional or non-transactional. For non-transactional rules, also specify the interval type and timing. For both types, indicate whether all columns should be updated.

	A	B	C	D	E	F	G	H	I
1	Source Site	Target Site	Category	Descr	Interval Type	Interval	Start Interval	Disable Rep	Update All Col
2	CAL	CAN	Site Admin		Transactional	0		0	0
3	CAL	CRP	Ledger Consolidation		Transactional	0		0	0
4	CAL	CRP	Site Admin		Transactional	0		0	0
5	CAL	ILL	A/P		Transactional	0		0	0
6	CAL	ILL	A/R		Transactional	0		0	0
7	CAL	ILL	Centralized Order Entry		Transactional	0		0	0
8	CAL	ILL	Inventory/Transfers		Transactional	0		0	0
9	CAL	ILL	Site Admin		Transactional	0		0	0
10	CAL	ONT	Centralized Order Entry		Transactional	0		0	0
11	CAL	ONT	Inventory/Transfers		Transactional	0		0	0
12	CAL	ONT	Site Admin		Transactional	0		0	0
13	CAL	USA	Ledger Consolidation		Transactional	0		0	0
14	CAL	USA	Site Admin		Transactional	0		0	0

Background information

After administrators have defined the source site, target site, categories, and time frames when replication will occur, they can write their replication rules: "Any time this data changes in this place, replicate it to this place." They then regenerate the replication triggers to enable the replication process.

Replication Rules form

You set up the replication rules in the Replication Rules form at each site. The spreadsheet you create in this step is the basis for the rules you set up. You can copy and paste rows from the spreadsheet into the grid view of this form.

	Source Site	Target Site	Category
1	ILL	CAL	A/P
2	ILL	CAL	A/R
3	ILL	CAL	Centralized Order
4	ILL	CAL	Site Admin
5	ILL	CAN	Site Admin
6	ILL	CRP	Ledger Consolidation
7	ILL	CRP	Site Admin
8	ILL	ONT	Centralized Order
9	ILL	ONT	G/L
10	ILL	ONT	Inventory/Transfer
11	ILL	ONT	Site Admin
12	ILL	USA	Ledger Consolidation
13	ILL	USA	Site Admin

Source Site:	ILL
Target Site:	USA
Category:	Site Admin
Description:	
Interval Type:	Immediate
Interval:	0
Start Interval At:	
<input type="checkbox"/> Disable Replication	
<input type="checkbox"/> Update All Columns	

Interval Type, Interval, and Start Interval At field usage

For each rule, use these three fields together to specify the interval at which replication will occur. For example, you might choose an interval type of **Minutes** and then specify **90** in the **Interval** field. All interval types except transactional are non-transactional, which means that there is no live connection to another site.

These interval types are available:

- **Transactional:** Provides a live constant connection from one site to another. Updates are made to the remote site immediately. No interval or start time is required.
- **Immediate:** Immediately sends the replicated data to the replication queue. This setting does not mean that the data is shown immediately in the other site. It depends on how soon the queue is retrieved by the other site. No interval or start time is required.
- **Minutes:** Replicates data every *nn* minutes, where *nn* is the value specified in the **Start Interval** field.
- **Hours:** Replicates data every *nn* hours, where *nn* is the value specified in the **Start Interval** field.

- Days: Replicates data every *nn* hours, where *nn* is the value specified in the **Start Interval** field.

Update All Columns field usage

Specify **Update All Columns** for a rule if you want every table column included in that category or rule to be updated on the target site even if it wasn't changed by a user interaction on the local site. This is not recommended for replication, due to the high data traffic it may generate.

If **Update All Columns** is not specified, replication occurs only for the columns that have been changed.

Rule execution

Replication happens chronologically, based on the order things happened in the source system. For example, an order line cannot be added until after the order is added. So, when looking at the list of tables in a category, the replication process changes data from the listed tables in the proper order - it does not simply run down the list of tables alphabetically to determine what is different.

Use the application event system to set up and maintain workflow or automated events. For a multi-site system, be aware of this information about events:

- Event handling is limited to the site(s) contained in the application database associated with the configuration governing the event object.
- The Dispatch IDO Request event action can initiate IDO activities in another site, if it specifies a URL() that controls activities in another site.
- If an event action effects a database change that normally triggers a replication activity, the replication activity will occur when the event action executes.

Will you be interfacing CloudSuite Business with a financial product, Analytics, a CRM product, an Infor BOD-enabled application, or a business partner product? If so, how does that affect your multi-site setup?

Some products run against a single CloudSuite Business site. In that case, make sure that all of the CloudSuite Business data that is required for the external product is replicated from other sites to the site that is connected to the external product.

Use the background information to help you determine how, or if, additional products will affect the setup of your multi-site system.

Updating the flowchart and spreadsheets

If you decide to rearrange your sites or rules due to add-on product requirements, update the flowchart and spreadsheets as needed.

Background information

Use this information to help you make multi-site decisions that are related to add-on products and modules.

APS

You can select either the Infor Advanced Planning & Scheduling (APS) or Material Requirements Planning (MRP) for planning your material requirements. There are two planning modes: APS and Infinite APS. In APS mode, you can set resources to have a finite capacity, while Infinite APS mode considers all resources to have infinite capacity. MRP and Infinite APS mode are built into CloudSuite Business. APS mode is a separately licensed CloudSuite Business module.

MRP plans requirements for items according to the level the item appears in a BOM, batching together requirements needed at the same period of time. APS and MRP both generate planned orders, which you firm into actual CloudSuite Business transactions. MRP and APS use the same basic input data. However, the APS system plans all requirements for one demand (through the end item's entire BOM), then plans all requirements for the next demand, and so forth for all the demands, based on order priority and each demand's due date.

APS generates real-time projections of when you can complete orders by comparing all demands against a long-term plan. The system views the current status, including inventory levels, forecasts, job schedules, PO due dates, customer orders, etc. and creates planned orders accordingly to satisfy the demands. You then "firm" the planned orders into purchase orders, purchase requisitions, job orders, production schedules, or transfer orders.

For more information about how APS (or MRP) is used, see the online help. The rest of this section focuses on how APS is used in a multi-site system.

The APS planning algorithm, which produces planning output that is sent back to the CloudSuite Business SQL database, uses a Planner database (PDB) as its in-memory database. Since the PDB is in memory and requires a lot of CPU when it is running, a separate Planning Server is required.

In a multi-site environment, you can generate a global plan for all sites defined in your APS Sites and Alternative Management form. Planned transfer orders are not created when you run planning in a single site.

There are two modes for global planning: Global Planning and Multiple Site Planning, which is defined on the Planning Parameters form, **Advanced APS** tab. In both modes, all sites are planned. The difference lies in how demands for components supplied by remote sites are planned.

With Global Planning mode, these demands are planned by contacting the remote site to get a realistic delivery date. A transfer supply is created at the local site and corresponding transfer demand is created at the supplying site.

With Multiple Site Planning mode, these demands are planned using lead time and planning replication creates the transfer demand at the supplying site.

A global plan generates all plans, transfer supply orders, and transfer demand orders for any remote components using up-to-date planning data at the remote site. To use this option, multiple sites must be defined on the APS Sites and Alternative Management form. The site you are logged into must be configured on the **Main** tab, and the other sites must be configured on the **Remote** tab. If **Global Planning Mode** is set to **Global Planning**, then each site must populate the **Main** and **Remote** tabs of the APS Sites and Alternative Management form. If **Global Planning Mode** is set to **Multiple Site Planning**, then you only need to add remote sites in the site where you will be running Global APS Planning. The sequence in which each site is planned is determined by the site priority defined at the local site where you run APS Planning.

Global Planning steps

When you run APS Global Planning in Global Planning mode, APS performs these steps:

- 1 Connects to all sites that are defined on the APS Sites and Alternative Management form. All sites' PDBs are now locked. No site is able to perform the Get ATP/CTP process or run APS Planning during the time of the global planning process.

- 2 Evaluates the site priorities and begins planning at the site that has the highest priority (the site with the lowest numerical priority value).
- 3 Removes and replans all demands at the site. Transfer orders are planned for any components supplied by a remote site.
- 4 Begins planning the next site in the site priority hierarchy.
- 5 When the system finishes replanning all sites, the global plan is complete and the PDBs are unlocked. At each site, any transactions entered in CloudSuite Business during the planning process while the PDBs were locked are now entered into the plan incrementally.

Multiple site planning steps

When you run APS Global Planning in Multiple Site Planning mode, APS performs these steps:

- 1 Connects to all sites that are defined on the APS Sites and Alternative Management form. All sites' PDBs are now locked. No site is able to perform the Get ATP/CTP process or run APS Planning during the time of the global planning process.
- 2 Evaluates the site priorities and begins planning at the site that has the highest priority (the site with the lowest numerical priority value).
- 3 Removes and replans all demands at the site (in single-site mode). For any component supplied by a remote site, replication is used to transfer that demand to the remote site.
- 4 Begins planning the next site in the site priority hierarchy.
- 5 When the system finishes replanning all sites, any remaining unplanned transfer demands are incrementally planned at each site.
- 6 When the system finishes planning the transfer demands, the global plan is complete and the PDBs are unlocked. At each site, any transactions entered in CloudSuite Business during the planning process while the PDBs were locked are now entered into the plan incrementally.

Transferred items

During global APS Planning, or during any incremental planning activity, if an item requires a component that is supplied by another site (that is, an "inter-site" transfer), transfer orders are planned using these steps:

- 1 Contacts the supply site that produces the remote item (based on the **Supply Site** field on the Items form).
- 2 Plans the item in a test copy of the supply site's PDB (also considering the transit time value defined on the Inter-Site Parameters form).
- 3 Plans the component in the supply site's master PDB and creates a planned transfer demand order.
- 4 Creates a corresponding planned transfer supply order at the site requiring the remote component.

Note: Due dates on planned transfer orders include transit time.

If APS Planning is unable to contact the supply site (due to the site's PDB being down, network problems, etc.), it uses the item's lead time and the transit time defined on the Inter-Site Parameters form to determine the projected availability of any remote components.

Transfer orders can automatically generate additional remote orders, depending on the component's requirements. For example, if site A needs a component that is produced at site B, and the component at site B requires a component produced at site C, APS Planning plans the demand transfer order at site C automatically.

Note: The system does not globally plan intra-site transfers (that is, items where the Supply Site is set to the local site).

After a transfer supply order is generated by a demand order, no other demand order can use inventory created by the transfer supply order. However, any excess inventory generated due to minimum lot sizes remains available at the supply site for other demands to allocate.

APS Planning creates planned transfer orders; you must firm them into actual transfer orders in the Planning Detail form or the Material Planner Workbench form.

In order to transfer items between sites, there must be a replication rule for the Inventory/Transfer category between the sites.

Site recursion in a bill of material

Global Planning mode does not support site-to-site recursion on a single order line. That is, an item at one site cannot require a component from a site that was a supply site higher in the item's bill of material. The Site Recursion limitation applies only to Global Planning, and not to Multiple Site Planning.

For more information about APS, see the online help.

Analytics

Infor Analytics for CloudSuite Business takes the data from your CloudSuite Business databases and turns it into multi-dimensional business information you can use to monitor financial, manufacturing, sales, inventory and purchasing data for your organization. The application includes these components:

- Infor ION BI OLAP Server for multidimensional analysis, planning and modeling
- Infor ION BI Repository to manage users, user groups, permissions and roles
- Infor BI Query & Analysis
- Infor ION BI Application Studio, used for reporting via Web browsers, with output to PDF and Excel.
- Infor ION BI Office Plus, which is an Excel interface for ad-hoc analysis or cell-based reporting.
- Infor ION Dashboards to provide quick views of KPIs relevant to a particular objective or business process.

When users generate BI reports, they can use the Site dimension to specify the site for which they want to see data, or specify **All** to view a summary of data for all sites. To restrict certain users to access only certain sites, instead of all sites, administrators can define data level permissions on the Site dimension.

Drill-through back to the CloudSuite Business application is not currently available.

Country packs and localizations

Country packs are optional, based on what your company has purchased. If a pack is licensed and installed, it applies to all sites in one application database. Use the Optional Modules form to enable or disable the features of a specific country pack at a specific site.

If a country pack is licensed for a database, but disabled for a particular site in that database, ensure that authorizations are set so that users cannot access forms that are part of the optional module.

Credit Card Interface

Using the Credit Card Interface for CloudSuite Business, users can enter and validate credit card information from a centralized customer order entry site, and then charge the card from a different shipping site where the invoice is generated. To use this feature, include the CCI Centralized Order Entry replication category in a replication rule. Then, when a user clicks **Pay with Credit Card** during order entry, if a successful authorization is received, the system replicates that authorization information to each of the sites that are set up to receive this replication category. When an invoice is generated in the shipping site, the system sees the replicated authorization and completes the credit card payment process. See the *Infor CloudSuite Business Credit Card Interface Configuration Guide* for more information.

DataViews and Critical Numbers

You can build DataViews and Critical Numbers over IDOs that show data from multiple sites. For Critical Numbers, you can write stored procedures that access data from any site. For more information, see the CloudSuite Business online help.

EDI

Electronic Data Interchange (EDI) is a module included with CloudSuite Business. EDI allows trading documents, such as purchase orders, shipment authorizations, advanced shipment notices, and invoices, to be communicated electronically so that they do not have to be re-entered manually. Companies exchange transaction data using data files in an ANSI standard format. CloudSuite Business, which is integrated with an EDI translator, imports inbound transactions from the translator and exports outbound transactions to the translator.

EDI is usually set up to work with one site. You can have multiple sites, each with its own setup and translator but not sharing EDI data. Or you may be able to set up a customized design for sharing EDI information in a multi-site system.

In CloudSuite Business versions previous to 8.0, EDI was a separately licensed module. EDI is now included in the standard product license.

Microsoft Excel add-in

With the CloudSuite Business add-in for Microsoft Excel, you can retrieve and format CloudSuite Business general ledger data from sites and entities into an Excel workbook to produce reports such as Balance Sheet, Profit/Loss Statement, and Cash Flow Statement.

You can associate different Excel worksheets in a single workbook with different site databases. For example, you could have one worksheet associated with Site A and another worksheet associated with Site B. You can then have a third "consolidated" worksheet that pulls information from Site A and Site B.

You can specify a site group in the Site parameter of these functions, to consolidate financial data from the sites in the group:

- SLGL
- SLGLBAL
- SLGLYTDBAL

Specifying a home site

As part of the setup for the Excel and Outlook Add-ins, you must specify a connection to either the application database or to the IDO Web Service. In a cloud environment, you must use the IDO Web Service option. For the IDO Web Service connection, you must specify a Web Client URL and/or an End Point URL. Infor provides these URLs in an email to you when your tenant is set up.

When a tenant is finished being created, the consumer will receive an email detailing a number of useful URLs. Both the End Point and Web Client URL values are provided.

Specifying a default site for a worksheet

The CloudSuite Business toolbar in Excel includes a Site drop-down list. The list is populated with sites that meet the criteria mentioned below.

To associate different worksheets with different sites, select a site name from the drop-down list in the toolbar. Then right-click on the worksheet tab and select Associate Site(sitename). The worksheet stays associated with that site even when you select a different default site name in the toolbar.

Associating a site with a worksheet is helpful, because the tool bar value then changes automatically when you select each worksheet and make the worksheet active.

Specifying sites in formulas

In individual cells of a worksheet, formulas can specify the site from which the data is pulled. If a site parameter is specified in the formula, the site that is explicitly supplied by the parameter is always used. Any formulas in the worksheet that do not specify a site name assume that the data is pulled from the site specified in the toolbar.

The site value on the toolbar is initially set to the "home" site. The site value in the toolbar changes when a worksheet is activated that has a different site associated with it. You can change the site value in the toolbar to specify a site other than the worksheet's associated site, as long as it meets the criteria listed below.

In most cases, we recommend that you include the site name in all formulas, to provide clarity about which site the data comes from. The exception to this is for dynamic worksheets that you run against different sites.

Note that there is nothing in the extracted data that indicates which site it came from.

Associating sites with a worksheet or using sites in formulas

A workbook can display data from more than one CloudSuite Business site, as long as these criteria are met:

- The site must be on the same database server as the home site.
- The site must be listed on the Sites/Entities form at the home site, and the Application Database field on that form must be filled in for the site.
- The user is authorized to access data on the other sites.

Any sites that meet this criteria are displayed in the drop-down list on the toolbar.

Licensing and permissions

In order to use the IDO Web Service, users must be assigned an Automation license. Also, certain middleware authorizations must be assigned for the user on the Object Authorizations for User form.

For more information about the Excel add-in, see the *Infor CloudSuite Business Microsoft Office Integration User Guide*.

Factory Track

One instance of Infor Time Track integrates with one CloudSuite Business site. This is true when Cloud Suite Business has multiple sites per database, and also when there is one CloudSuite Business site per database. Each Time Track instance must be in its own database. The databases can all be on one database server.

EveryCloudSuite Business site is provisioned with a matching Factory Track tenant. Each Factory Track site is in a separate database (and therefore tenant). Multiple sites per database are not currently supported for Factory Track.

BOD-enabled applications (ION)

Infor uses the ION enterprise messaging system to transport data between CloudSuite Business and other Infor BOD-enabled applications. The data exchanged is sent as XML documents referred to as Business Object Documents (BODs). These documents are defined by Open Applications Group Integration Specifications (OAGIS).

In order to integrate with BOD-enabled applications, a connection point is defined for each site within CloudSuite Business, and then a document flow must be set up between the connection point and the other application.

Industry packs

Industry packs are optional, based on what your company has purchased. If a pack is licensed and installed, it applies to all sites in one application database. Use the Optional Modules form to enable or disable the features of a specific industry pack at a specific site.

If an industry pack is licensed for a database, but disabled for a particular site in that database, ensure that authorizations are set so that users cannot access forms that are part of the optional module.

Mobile

In mobile forms where a user can view data from different sites, a **Site** drop-down list is displayed on the form. If the form's data comes from an `_all` table, no logging in and out of sites is needed. However, in the case of a customer address, the `custaddr_mst` table can be shared among multiple sites. When the table is shared, the **Site** list is populated with sites that are participants in the sharing. When the table is not shared then the list displays only the current site.

If the data must be accessed from separate site databases, then the user must select a configuration from the list and tap the **Switch** link to "switch sites." Behind the scenes, a URL is built that includes the name of the Web server, the new configuration, the current form, and the user's name. A login screen to the other site is displayed. If you want the switch to be seamless, without requiring the user to enter a password, then set up the user with a workstation login in that site.

The use of the Switch Sites feature assumes that all of your sites use the same web client on the same web server.

Office Application Search Service

The search is performed only on the site (configuration) that is specified in the Select a **Config** field during the search service setup in Microsoft Office. However, users can point to a different site by changing the configuration value.

For more information about the Application Search Service, see the *Infor CloudSuite Business Microsoft Office Integration User Guide*.

Outlook

We recommend that users connect to the same site each time they use the CloudSuite Business add-in for Microsoft Outlook. Users can change the setup to point to a different configuration; however, this can cause duplicate contacts in Outlook, because the row pointer of the contact record is different in different CloudSuite Business databases. There are cases where switching sites can be useful; for example, you could copy SiteA contacts into Outlook, and then copy those contacts from Outlook into SiteB.

As part of the setup for the Excel and Outlook Add-ins, you must specify a Web Client URL and/or an End Point URL. Infor provides these URLs in an email to you when your tenant is set up.

For more information about the Outlook Add-in, see the *Infor CloudSuite Business Microsoft Office Integration User Guide*.

Configure Price Quote (CPQ)

You can use Infor Configure Price Quote (CPQ, formerly PCM or BuyDesign) with CloudSuite Business to configure products. A site parameter is passed to the Configurator through the configuration Header ID.

Some previous versions of this product required unique order prefixes in each site, in order for configurations to work properly in a multi-site, single database environment. Unique order prefixes are no longer required for CPQ configurations. (However, unique order prefixes are still required in each site in CloudSuite Business if you use centralized order entry features such as shipping lines from remote sites.)

Portals

Customer, Vendor and Reseller Portal Web pages can connect to multiple sites, to display and update data from those sites. Portals have a primary site, where key data such as items and item categories is maintained by CloudSuite Business users. Some data is obtained strictly from the primary site; other data comes from all sites.

These methods of retrieving and maintaining data to or from multiple sites are used:

- Use a multiplex data source, known as a portal site group, to retrieve or save data simultaneously to or from all sites tied to the portal, or to execute a method simultaneously in each site.
- Use RemoteMethodCall to affect or retrieve data to or from multiple sites.
- Use CloudSuite Business `_all` tables to obtain multi-site data by connecting to a single site.

Define portal data source configurations through the Portal Manager, to include databases for each site in the portal site group:

- One of the data sources must be named **PrimarySite**, which points to the single CloudSuite Business database where all portal-enabled items and item category hierarchies must be defined. Other data must also be maintained in this primary site.
- One of the data sources must be named **PortalSiteGroup**. This data source must include the primary site and all other sites that the portal can access. The PortalSiteGroup is the default data source.
- If there is only one site in the portal site group, both the primary site and portal site group data sources must be defined and must point to the same site.
- If one of the sites to be exposed to the portal is a master site, then the portal site group must be a site group in which the master site is included.

In this case, we recommend that the primary site of the portal be the same as the master site, although this is not required. If you make them the same site, you can use the Multi-Site Items, Multi-Site Customers, and Multi-Site Vendors forms in the master site (primary site) to maintain data across the other sites in the intranet. A master site user can then copy items from the non-master sites to the master site, which is useful because all portal-exposed items must be listed in the primary site's item_mst table.

- If a master site exists, and users are shared through the Intranet Shared User Tables form, then the primary site must be the master site. For more information, see the *Infor CloudSuite Business Licensing Administration Guide*.

In the Site Groups form, define a group that is assigned to the portal. This group is identified as the portal site group in the Portal Parameters form. This group must include all sites that contain information that is displayed in the Customer Portal or Vendor Portal.

Replication rules

All sites in the portal site group must be linked and replicated using standard replication rules. For the Vendor Portal, the A/P and Vendor Portal replication categories must be replicated across all sites in the Vendor Portal site group. For the Customer Portal and Reseller Portal, the A/R, Centralized Order Entry, and Customer Portal replication categories must be replicated across all sites in the Customer Portal site group.

Accounts Receivable

If you plan to use the Customer Portal in a multi-site setup, define the aging bucket in the CloudSuite Business Accounts Receivable Parameters form the same way in all sites included in the Customer Portal site group.

If the Customer Portal site group contains a different set of sites than the Accounts Receivable site group, the customers' account balance data will not equal the balance shown in the CloudSuite Business Accounts Receivable Transactions Summary form, and might not represent the actual aging information.

Customers

If you plan to use the Customer Portal in a multi-site setup, all customer records must use consistent customer numbers across sites, that is, Customer 1 in site A must be the same as Customer 1 in site B.

Interactions

When CloudSuite Business users subscribe to interaction alerts, they must subscribe to the alert in the site where they are responsible. If CloudSuite Business users also want to be notified of interactions created from the portal that do not reference a specific object, they must also subscribe to the alert in the primary site. Portal users who subscribe to an interaction alert are subscribed to that publication in all sites.

The same set of interaction topics must be defined in each site of the Customer Portal site group. Interactions topic translation must be the same across all sites that belong to a portal site group, for Customer Portal, Reseller Portal and Vendor Portal.

Resellers

A customer can be associated with only one reseller across all sites in the portal site group. A customer is either associated with a reseller or is not associated. This must be true across all sites and Ship To records. Salesperson IDs used for reseller association must reference the same vendor number across sites.

Vendors

If you plan to use the Vendor Portal in a multi-site setup, all vendor records must use consistent vendor numbers across sites, that is, Vendor 1 in site A must be the same as Vendor 1 in site B. If a vendor is not defined in any site, then no data for that site is displayed for the logged-in vendor.

Users

The sites from which information is displayed to portal users depend on the type of login, the type of portal, and the specific portal page.

For example, on the portal pricing pages, B2B customers can see pricing for the item at all sites connected to their primary site, but B2C customers and pre-login customers can only see pricing for the item at their default site.

The user account must exist in all the sites of the Portal Site group. If the portals connect to multiple sites and the user account is missing in any of these sites, access is denied on login.

Service

Infor CloudSuite Business Service is an optional module with separate licensing. The multi-site setup includes adding rules for replication categories related to the Service module. See "Replicating Service data" on page 74.

Determine which users, and how many users, must work in multiple sites. Determine the types of licenses these users require.

You might already have had some discussions with your sales representatives about licensing. This step refines your existing licensing decisions based on the multi-site planning decisions you have made.

Considerations

Consider these questions:

- How many people need access to only one site?
- How many people need access to multiple sites?
- How many people need access to entities?
- What modules or add-on products require additional licensing per database?
- Will you have custom forms?
- Do you want to control licensing for all sites on an intranet from a master site?
- Will you use demo and/or pilot databases?
- Will you be using Infor Ming.le widgets, the Excel add-in, or other automation sessions to display information from CloudSuite Business IDOs?
- Will your customers be accessing CloudSuite Business data through a portal?
- Will your users be accessing CloudSuite Business from their mobile devices?
- Will your users be accessing CloudSuite Business forms from within Microsoft Outlook?

The Infor Cloud team applies your license to your cloud environment. However, you must determine what licenses you need before the license document can be provided.

Creating a License spreadsheet

Review the background information in the *Infor CloudSuite Business Licensing Administration Guide*. Then create a License spreadsheet to list the types and number of licenses you need.

Consult your Sales Representative about any changes to your existing license requirements.

Background information

Review the *Infor CloudSuite Business Licensing Administration Guide* for information about how licenses are used in a multi-site environment. This document explains the licensing of modules in a multi-site environment, how the intranet licensing option works, and which product and module licenses have special multi-site versions.

If you have a large multi-site system, you will have many site IDs, site names, configuration names, intranet names, group names, and database names to manage. Now that you have set up your initial plan, review the flowcharts and spreadsheets for naming consistency.

It is easier to keep track of which site users are currently logged into, if the names you use are logical, and the configuration name matches the application database name, which matches the site name, and so on.

Considerations

Consider this information:

- Avoid generic site names (for example, "Site1") that do not differentiate your sites. Use names that describe the location, the hierarchy, or what the site is used for.
- Configurations for your sites are named based on Infor standards.
- Avoid using these special characters in configuration names and site IDs or site names:
 - \ (back slash)
 - / (forward slash)
 - : (colon)
 - * (asterisk)
 - ? (question mark)
 - " (double quote)
 - ' (single quote)
 - < (left arrow)
 - > (right arrow)
 - | (vertical bar)
 - (embedded space)
- For site groups, use names that define their function (for example, FINANCE) or their location (for example, PACIFIC), depending on the logical grouping.

- Do you want to use prefixes to distinguish site-specific customers, vendors, jobs, transfer orders, purchase orders, and so on?

Updating the flowchart and spreadsheets

If you decide to change your naming conventions based on the information in this chapter, update the flowchart and spreadsheets as needed.

Determining prefix use for records in different sites

Determine whether you want to include site-specific prefixes on customer and purchase orders, transfers, and so on.

Background information

Use this information to better understand the concepts.

Prefixes

At each site, you can specify prefixes for these types of records:

- Applicant
- Builder invoices
- Builder purchase orders
- Builder vouchers
- Container
- Co-product mix
- Current job
- Customer
- Customer order
- Customer order contract
- Delivery order/BOL
- Drop Ship number
- EDI order

- EDI order acknowledgement
- Employee
- Estimate
- Estimate job
- Estimate project
- Export document
- Job
- Lot
- Maintenance ID Prefix (on Resources form)
- Office
- PO contract
- Point-of-sale customer order
- Point-of-sale service order
- Position
- Production schedule
- Project
- Purchase order
- Purchase order requisition
- RFQ
- RMA
- Schedule ID
- Serial number
- Transfer order
- Transfer/Project BOL
- Vendor
- Vendor-created PO
- Vendor-created PO requisitions

For example, if you specify **CO** as the prefix for customer orders, the default customer orders created in this site will be CO00000001, CO00000002, CO00000003, and so forth. If you do not enter a value in the **Order Prefix** field, the default customer order numbers used in this site will be 1, 2, 3, and so forth.

A prefix can consist of numeric and non-numeric (letters and symbols) characters. However, the prefix should end with an alphabetic character to ensure that the system increments order numbers correctly.

When you reach the 10-character limit, the system prompts you with a warning message. You must start a new prefix sequence. In the CO example, when you reach CO99999999, you must begin a new customer order prefix.

Using a site indicator in the prefix

For some types of records, you might want to include a site indicator as part of your prefix, to avoid duplication between sites, and to provide a larger pool of transfer order numbers.

For example, you have a site located in Dallas that uses 'TD' as the transfer prefix, and another site in Columbus that uses 'TC' as the transfer prefix. By default, CloudSuite Business then creates transfer order numbers at the Dallas site with a prefix of 'TD', for example TD00000001, TD00000002, TD00000003, etc.

When you create a transfer order in Dallas that will be shipped to the Columbus site, the next default transfer order number for Dallas is used, for example TD0000000321. The system also automatically creates a complementary record in Columbus with the same transfer order number, TD000000321.

The creation of the complementary record provides you with a way to track a transfer order between two sites. In this example, both Dallas and Columbus will recognize 'TD000000321' as the same transfer. Besides avoiding duplication, another benefit of using a meaningful transfer order number prefix is that you can determine which site originated the transfer order.

Be aware that adding a prefix limits the number of digits available for the record number. If you use a long prefix, you will have a smaller pool of numbers available.

Also be aware that prefixes are only used when you allow the system to auto-generate new records.

Lot and serial prefixes

Lots and serial numbers can use "intelligent" prefixes. The prefix can include information such as the date or job number, reference information or a site ID.

For more information about intelligent prefixes, see the online help.

Item numbers

Generally, item numbers are descriptive of your products and are not site-specific. If an item will exist in multiple site databases, you should use the same item number for the same part in every site. This allows you to ship items across sites, perform transfers, and so on.

Now that you have a hierarchical structure of sites, and rules for setting up data flow between them, consider how any radical change to that structure will affect it:

- How will later additions/deletions of sites, or changes to existing sites, affect this structure? Is it set up in a way that will allow changes with the least disruption?
- What if your company buys another company - possibly in a different country? What if your company is acquired? Will this structure be flexible enough to accommodate those changes?
- What if the new company uses a different financial reporting system, or different domestic currency?
- What if one site has to be taken down for maintenance? Will the structure allow your business to continue running during that time?

Revising your flowcharts and spreadsheets

If you decide to rearrange your hierarchical structure or data flows after reviewing the questions in this chapter, then update the flowchart and spreadsheets to match.

Background information

Use this information to better understand the concepts.

Changes to your reporting structure

Over time, sites come and go and the hierarchy of entities may change. As these changes occur, the historical consolidated financial data will not change, and a historical time-phased site/entity structure will be maintained. This allows prior period reporting and drill-downs to yield identical results, even after the structure has changed. On the date of a reporting structure change, a large transaction is posted to close out all accounts for all selected subordinate sites, computing the account balance of

each account. Half of this transaction is immediately consolidated to the existing structure, effectively zeroing the balances from the books. After the hierarchy is changed, the other half of the transaction is consolidated to the new structure, creating opening balances for all the accounts. At the site level, this has no effect, since a debit and credit for the same amount is posted to the same account on the same date.

Be aware of the these rules when changing the reporting hierarchy:

- Financial statement reporting at entities only shows data for transactions that occurred during the time period that the hierarchy was in place.
- When you change an entity's Reports To mapping, there is no historical audit trail of how it was formerly set up.
- Transactions are consolidated to the current structure only, regardless of effective date of the hierarchy change or the ledger transaction date.

Replication overview



The information in this appendix is similar to the first chapter in the *Mongoose Replication Reference* guide, available on our support site. For more details about how replication works, please refer to that guide.

Note: Most of this section is intended for users who have sites in different application databases. If you have all of your sites in one application database, see "Multiple sites in one database" on page 114.

About replication

Data replication is the copying of data between CloudSuite Business sites. The site whose data will be copied is the source, or local, site. The site receiving the copied data is the target, or remote, site.

Replication also allows the system to transmit procedure execution requests (SPs) between the source and target sites.

Infor CloudSuite Business supports two replication methods: transactional and non-transactional.

Transactional replication

This method (also sometimes referred to as "synchronous" or "connected") performs updates on the target site, based on the transaction being performed at the source site. All changes on both the local database and the target database are committed or rolled back together. Transactional replication assumes that the source site and the target site are always connected through SQL Server and have the same database schema (same CloudSuite Business version).

Transactional replication allows immediate updates between databases without the use of queues or XML-formatted content. Only database triggers and direct stored procedure calls are used to replicate the data.

Data errors (for example, requesting an item that does not exist at the specified remote site) are caught immediately, and the system will not allow the user to save the record with the error.

Transactional replication generally should be used between sites on the same intranet. For best performance, both site databases should be on SQL Server machines within the same LAN, or even on the same SQL Server machine.

Non-transactional replication

This method (also sometimes referred to as "asynchronous" or "delayed") assumes that the source site and target site may not be connected through SQL Server. Non-transactional replication uses inbound/outbound queues and XML documents to transfer data or to pass application calls (remote procedure calls, or RPCs).

In a Cloud environment, non-transactional replication is used only for transmission of BODs to and from ION.

General notes about replication

You can use transactional replication between some of your sites and non-transactional replication between others; it depends on how the sites are connected and how quickly you want the data to be available.

When data is updated in the target system via replication, the replication process bypasses business rule validation and triggers, so replication should only be performed between "trusted" sites. Referential integrity and database-level constraints still apply. Note also that trigger validation is not applied to tables in any case.

_All tables

The application database can include many tables ending in "_all." In a single-site database, these tables contain data for all sites, while the corresponding base tables contain data only for the local site. The _all tables might include only a subset of the columns from the base table—just enough information to perform local processing on other sites' data.

Example

A system has two sites, OH and MI. OH is replicating its billing terms data to MI, and MI is replicating its billing terms data to OH. The OH_App database has a terms_mst table with these columns and rows:

terms_code	description	due_days	disc_days	disc_pct	prox_day	tax_disc	cash_only	prox_code
2%	2/10 Net 30	30	10	2	0	0	0	99
2%P	2/10 Proxy 30	0	10	2	30	0	0	99
4%	4/10 Net 30	30	10	4	0	0	0	99
4%P	4/10 Proxy 30	0	10	4	30	0	0	99
5%	5/10 Net 30	30	10	5	0	0	0	99

The MI_App site database has a terms_mst table with these columns and rows:

terms_code	description	due_days	disc_days	disc_pct	prox_day	tax_disc	cash_only	prox_code
COD	COD Only	0	0	0	0	0	0	99
N15	Net 15 Days	15	0	0	0	0	0	99
N30	Net 30 Days	30	0	0	0	0	0	99
N45	Net 45 Days	45	0	0	0	0	0	99
NT	No Terms	0	0	0	0	0	0	99
P30	Proxy Day 30	0	0	0	30	0	0	99

Both OH and MI also have a terms_mst_all table with these columns and rows:

Notice that the terms_mst_all table has a site_ref column to distinguish the records for each site. It does not include all the columns from the base table - only the ones that typically would be used in a multi-site environment.

When a billing term is added at OH or MI, the _all tables at both sites are updated.

site_ref	terms_code	description	tax_disc
OH	2%	2/10 Net 30	0
OH	2%P	2/10 Proxy 30	0
OH	4%	4/10 Net 30	0
OH	4%P	4/10 Proxy 30	0
OH	5%	5/10 Net 30	0
MI	COD	COD Only	0
MI	N15	Net 15 Days	0
MI	N30	Net 30 Days	0
MI	N45	Net 45 Days	0
MI	NT	No Terms	0
MI	P30	Proxy Day 30	0

General notes about _All tables

_All tables at the local site are populated with local site data through database triggers when the base table is updated. The _all table may also contain remote site data, populated through replication (depending on the replication rules defined at the remote sites).

_All tables are used when the information in a base table is not typically shared among sites (for example, customer orders or transfers). When the information in a base table is typically shared among all sites (for example, customer addresses), there may be no need for an _all table. Data is replicated directly from the base table in the source site to the base table in the target site. So, such tables usually are replicated directly.

Replication categories and rules

See "Sharing data between sites" on page 57 for descriptions of the default replication categories that are included in this application, with detailed information about each category

These standard categories have been tested to ensure that they include all the necessary database tables, stored procedures, and/or XML documents required to replicate the information used in the specified application function. For example, the A/P category contains the components needed for replicating your Accounts Payable data, the G/L category contains the components needed for replicating General Ledger, and so on. The categories can be included "as-is" in your replication rules.

Using categories with rules

To replicate a category to other sites, create a replication rule for each source-target site combination. For example, if you want to replicate order entry data from site OH to site MI, and you want to use transactional replication, create a rule in the Replication Rules form at the OH site.

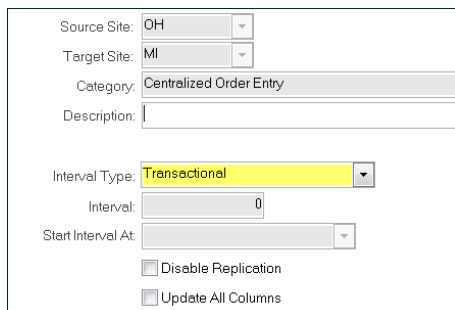

The screenshot shows a form for defining a replication rule. It includes the following fields and options:

- Source Site: OH (dropdown)
- Target Site: MI (dropdown)
- Category: Centralized Order Entry (text field)
- Description: (empty text field)
- Interval Type: Transactional (dropdown, highlighted in yellow)
- Interval: 0 (text field)
- Start Interval At: (dropdown)
- Disable Replication
- Update All Columns

After the rule is defined and saved, click **Regenerate Replication Triggers** on the Replication Management form. This regenerates the table triggers so that the data is replicated according to the specifications in the category and rule.

In certain cases, replication rules and categories determine which sites are available when performing CloudSuite Business functions.

For example, if there is no replication rule set up for Centralized Order Entry from the local site to any other site (or if the rules are disabled), then, when a user accesses the Customer Order Lines form at the local site, the form's **Ship Site** field is disabled and the order must be shipped from the local site. If there is at least one enabled replication rule for Centralized Order Entry, the **Ship Site** field is enabled and lists all available sites. When the user then selects a ship site, the system validates that there is an enabled replication rule for Centralized Order Entry from the local site to the selected remote site. If not, an error message is displayed.

For most other forms that specify a remote site, the system validates a record against the `_all` tables to determine whether the record may be saved. For example, assume you have a transactional replication rule being used to replicate the Inventory/Transfers category between sites. A person creating a transfer order line at the local site selects a remote site from which the item will be transferred, and then tries

to save the record. The system checks the `item_mst_all` table to determine whether the selected remote site database contains the specified item. If not, the record validation displays an error.

Point to point replication

Replication is point-to-point between sites. There is no "routing forward."

Consider this example:

- Site A has a rule to Site B that replicates category X (which includes the table xxx).
- Site B has a rule to Site C that replicates category X.
- Site A does not have a replication rule to Site C that replicates category X.

If the xxx table is updated at Site A, the change is replicated to the xxx table at Site B; however, that change is not replicated from Site B to Site C. For an xxx table change at Site A to be replicated at Site C, there must be a replication rule in Site A that sends that data to Site C as well.

Intranets

When you configure a site, you assign it to an intranet on the Sites or Sites/Entities form. Intranets are used to segregate a company's sites into virtual groupings that reflect the actual network setup.

Usually, all the sites on the same LAN and/or database server will belong to the same intranet, and usually sites on different database servers are in different intranets, as shown in this flow chart:

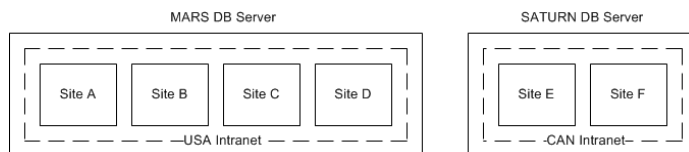

However, it is possible to set up sites on the same database server that are in different intranets, as shown in this flow chart:

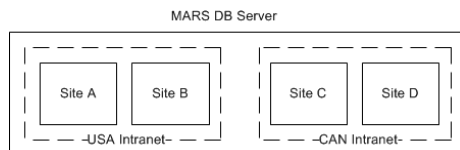

It is also possible to set up one intranet with sites on different servers, as shown in this flow chart:

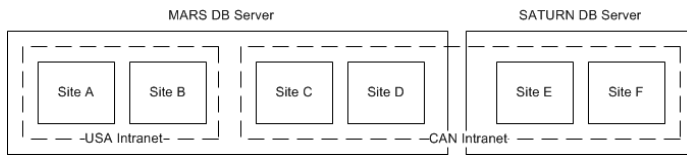

If you have multiple sites in a single application database, and if the sites are sharing `_all` or user tables (through the Intranet Shared Tables or Intranet Shared User Tables utilities), then all sites in that database must be on the same intranet.

Generally, transactional replication should be performed only between sites on the same database server, for performance reasons. However, if your database servers are on a very fast network, transactional replication between sites on different servers is possible.

When a system includes multiple intranets on different servers, the data generally should be transferred between intranets through non-transactional replication (XML documents). When the schema in the source and target databases are not identical—for example, CloudSuite Business to another application that uses Mongoose, or different versions of your application—an XSL transformation (style sheet) should be used. Each intranet has an ASP page that provides intranet access to the inbound queue. The ASP is the gateway to other databases. The address of the ASP is defined on the Intranets form.

Master sites and shared tables

If your environment has many sites, large amounts of shared data, and many users, you may want to set up one site as the master site for an intranet. Master sites are CloudSuite Business sites that control some data for all other sites on an intranet.

If you use a master site, certain tables can reside only on the master site and are shared (read and written to through a SQL view) by other sites on the same intranet. No replication needs to occur for the shared tables, which can greatly improve system performance and simplify the setting up of replication rules.

After you set up a master site for an intranet and share tables between the sites on the intranet, the intranet is considered a "shared table" intranet. You can add new sites to a shared table intranet. Removing sites from a shared table intranet is more complex, because you must first unshare the shared tables (that is, recreate them) at the site being removed from the intranet. For more information about sharing and unsharing `_all` and user tables, see the online help.

For more information about setting up master sites and shared tables, see the online help and the *Infor CloudSuite Business Multi-Site Implementation Guide*.

Multiple sites in one database

Consider the information in this section when all sites are in a single database.

Replicating _all tables

If all sites in your system are in the same application database, the base tables already contain data for each of the sites, so the _all tables are not populated and are simply views to the base tables. In that case, replication of _all table data is not necessary.

Replicating base tables

Base tables can include a multi-site column that contains the site name, so that each site in the database can maintain its own records in the table.

You might want to replicate base table data between two sites in the same database. For example, you might want to maintain codes at one site and replicate them to other sites in the database. Whenever a change is made to a code record in the OH site, you want to replicate that change to the MI site. You could set up a replication category that includes the code table, with the Retain Site field cleared. (Clearing the Retain Site field allows the system to create or update a record in the same database table.) Then you create a rule from OH to MI that includes that category.

Replicating shared tables

Shared tables have names that do not end in _all, and they do not contain a site_ref column. For example, the Event table is shared. If all sites in your system are in the same application database, the data for these tables is shared across all sites; that is, the data is not split out by site. In that case, replication of shared table data is not necessary.

Replication category tables

B

This appendix contains brief descriptions of the objects in each of the predefined categories.



Caution: Except where specifically noted, these tables and methods are often used by multiple forms and processes, so removing them from a category might have unintended consequences.

A/P category

A/P object name	Used for
apdrafft_mst_all	A/P draft transactions
apparms_mst_all	Accounts payable parameters - used in A/P payment distribution and generation
ApSitPmtpSp	A/P check/draft/wire/EFT posting
aptrxp_mst_all	A/P posted transactions - used in many A/P areas
bank_addr_mst_all	Bank addresses
bank_hdr_bank_file_fmt_all	Bank code and bank file format cross-references
bank_hdr_mst_all	Bank reconciliation header information
chart_mst_all	Chart of accounts - used throughout the system
chart_unitcd1_mst_all	Unit codes - chart of accounts
chart_unitcd2_mst_all	Unit codes - chart of accounts
chart_unitcd3_mst_all	Unit codes - chart of accounts
chart_unitcd4_mst_all	Unit codes - chart of accounts
commdue_mst_all	Commissions due - used in A/P payment generation/distribution
country_mst	Country codes - used throughout the system
curr_uk_mst_all	Customs and excise exchange rates

Replication category tables

A/P object name	Used for
curracct_mst_all	Default currency accounts - used in currency codes, A/P and A/R payment, distribution, and quick payments
currate_mst_all	Currency rates - used throughout the system
currency_mst_all	Currency codes - used throughout the system
currparms_mst_all	General currency parameters
DelVendaddrSp	Vendor addresses
euro_parms_mst_all	Euro parameters - used throughout the system
item_mst_all	Items - used throughout the system
journal_mst_all	Only used by the Journal Transaction Report. If you do not need to see Journal records from another site, this is not needed.
parms_mst_all	General parameters - used throughout the system
periods_mst_all	Accounting periods - used in many financial areas
poparms_mst_all	Purchase order parameters
RemoteSaveAprxpSp	A/P Posted Transaction Detail
RemoteSitpmt2Sp	Update information in the To site for A/P payment posting. This involves setting the Active flag on the AP Posted Transaction (if it is not already set), creating a journal (debit) entry to Accounts Payable - Liability, creating a journal (credit) entry to Purchase Expense - Discount, creating a journal entry to Inter-Site Liability, updating the vendor's discount YTD, and creating an A/P Posted transaction.
slsman_mst_all	Salespersons - used in A/P payment generation and in the Order Verification Report
tax_system_mst_all	Tax systems - used in A/P payment generation and A/P check/draft/wire/EFT printing/posting
taxcode_mst_all	Tax codes - used in A/P payment generation and A/P check/draft/wire/EFT printing/posting
taxparms_mst_all	Tax parameters - used in A/P check/draft printing/posting
terms_mst_all	Billing terms - used in accounts payable aging
THAApSitPmtSp	Thailand localization
unitcd1_mst_all	Unit codes
unitcd2_mst_all	Unit codes
unitcd3_mst_all	Unit codes
unitcd4_mst_all	Unit codes
vch_hdr_mst_all	Voucher register - used in A/P payment generation

A/P object name	Used for
vch_item_mst_all	Voucher line item - used in voucher listing
vendaddr_mst	Vendor address - used throughout the system
vendcat_mst_all	Vendor categories
vendor_mst_all	Vendor information - used throughout the system
VendorInsUpdSp	Insert/update vendors

A/R category

A/R object name	Used for
ar_terms_due_mst_all	A/R multiple due date payment terms
ARActiveSp	Setting Active flag for A/R transactions
arparms_mst_all	Accounts receivable parameters
ARPaymentDistPostingSp	A/R payment distribution posting
ARPayPostRemoteCopyNotesSp	A/R payment posting - copy notes
ArpmtpblSp	Validate customer number during A/R payment posting
ArSitpmt2Sp	Find invoice information from a specified site and apply an open credit/payment to an invoice during quick payment
artran_mst_all	Accounts receivable transactions
ArtranUpdSp	When information is updated on the A/R Posted Transaction Detail form, this is called to update the information on the referenced site.
chart_mst_all	Chart of accounts - used throughout the system
chart_unitcd1_mst_all	Unit code - chart of accounts
chart_unitcd2_mst_all	Unit code - chart of accounts
chart_unitcd3_mst_all	Unit code - chart of accounts
chart_unitcd4_mst_all	Unit code - chart of accounts
coparms_mst_all	Customer order parameters (includes invoice length, used in many A/R functions)
country_mst_all	Country codes - used throughout the system
CreateArInvSp	Create an (unposted) A/R invoice using information passed to it from ReturnedChecksSp.

Replication category tables

A/R object name	Used for
curr_uk_mst_all	Customs and excise exchange rates
curracct_mst_all	Default currency accounts - used in Currency Codes, A/P and A/R payment, distribution, and quick payments
currate_mst_all	Currency rates - used throughout the system
currency_mst_all	Currency codes - used throughout the system
currparms_mst_all	General currency parameters
cust_lcr_mst_all	Customer letters of credit
custaddr_mst	Customer address
custdrft_mst_all	Customer draft
customer_mst_all	Customers information
custtype_mst_all	Customer types
DeleteRemoteNotesSp	Delete notes tied to a record at a remote site
endtype_mst_all	End user types
euro_parms_mst_all	Euro parameters - used throughout the system
inv_category_mst_all	Invoice category
inv_hdr_mst_all	Invoice header
inv_item_mst_all	Invoice line item
inv_stax_mst_all	Invoice sales tax
item_mst_all	Items - used throughout the system
LoadReplicatedNotesSp	Take a row out of the NotesContentShadow table and updates the matching system, user, or specific note. If the note does not exist, it is created.
MakeRemoteObjectNotesSp	Create an ObjectNotes record at the remote site. It assumes the system, user, or specific notes records have already been created.
MXVATARMultiSiteTransDirSp	Mexican localization
NotesContentShadow	System, user, or specific note information used to populate the appropriate notes record at the remote site.
parms_mst_all	General parameters - used throughout the system
periods_mst_all	Accounting periods - used in many financial areas
RebalCuSp	Rebalance customer balances
RemoteSetArtranCorpCustSp	Corporate customer for A/R transactions
sales_team_mst_all	Sales team

A/R object name	Used for
territory_mst_all	Sales territory
TransferNotesToSiteSp	Allow all the notes for a particular row of a table to be copied to a remote site.
unitcd1_mst_all	Unit code
unitcd2_mst_all	Unit code
unitcd3_mst_all	Unit code
unitcd4_mst_all	Unit code
UpdObalSp	Update customer order balance
UpdPbalSp	Update posted balance

CCI Centralized Order Entry category

CCI object name	Used for
cci_parms_mst	Credit Card Interface parameters
CCICentralOrderEntryReplicateSp	Credit Card order entry information

Centralized Order Entry category

COE object name	Used for
arparms_mst_all	Accounts receivable parameters
cfg_attr_mst_all	Attributes in a configuration
cfg_comp_mst_all	Components in a configuration
cfg_main_mst_all	Configuration description
cfg_ref_mst_all	Configuration reference type information
CfgCheckRemoteXref	Used in processing configured order lines that are shipping from a different site than the order site.
CfgClearRemoteXref	Used in processing configured order lines that are shipping from a different site than the order site.
CfgCreateItemSp	Used in processing configured order lines that are shipping from a different site than the order site.

Replication category tables

COE object name	Used for
CfgRepRemoteConfig	Used in processing configured order lines that are shipping from a different site than the order site.
CfgRepRemoteItemSp	Used in processing configured order lines to set the item and configuration in the order site.
chart_mst_all	Chart of accounts - used throughout the system
ChgRemoteCoitemSp	Change the status in the shipping site (if not currently in the shipping site)
citemh_mst_all	History customer order line/release
co_bln_mst_all	Blanket orders
co_mst_all	Customer orders
co_ship_approval_log_mst_all	Customer order shipment approval
co_ship_mst_all	Customer order shipments
CoChangeToHistSp	Change customer order status
coh_mst_all	History customer orders
CohShipSiteDelSp	Delete customer order history at shipping site
coitem_log_mst_all	Only used by the Item Product Code Cost Detail Sales Analysis Report.
coitem_mst_all	Customer order lines
CoitemSp	Replicate CO line (multi-site)
CoLineRelWarehouseChangeRemote1Sp	Change the warehouse on the customer order line in the shipping site
CoLineRelWarehouseChangeRemote2Sp	Change the warehouse on the customer order line in the originating site
coparms_mst_all	Order entry parameters
CopyNotesFromOrigSiteSp	Copy notes from original site
country_mst	Countries (local site)
country_mst_all	Countries (includes remote sites)
CpSoCpSoCb2Sp	Recopy columns back to the originating site when updated on the ship-site for blanket lines
CpSoCpSoCbSp	Copy a blanket line to the ship-site and perform secondary posting
CpSoCpSoCi2Sp	Recopy columns back to the originating site when updated on the ship-site for regular lines.
CpSoCpSoCiSp	Copy a customer order line to the ship-site and perform secondary posting

COE object name	Used for
CpSoCpSoDbSp	Delete a blanket line to be replaced due to copying
CpSoCpSoDiSp	Delete a customer order line to be replaced due to copying
CpSoCpSoDoSp	Delete a ship-site customer order that no longer has any lines
CpSoCpSoSoSp	Sum the order balance at the ship-site for setting the customer order balance
CrtLogSp	Create a customer order line Change Log record for each blanket release of a blanket line
curr_uk_mst_all	Customs and excise exchange rates
CurrAcctSp	Create a curracct row in the remote site for the currency row just added in the local site. (The record is created but account information is not replicated.)
currate_mst_all	Currency rates - used throughout the system
currency_mst	Currency codes
currency_mst_all	Currency codes (includes remote sites)
currparms_mst_all	General currency parameters
cust_lcr_mst_all	Customer letters of credit
custaddr_mst	Customer addresses
customer_mst_all	Customers
DelCoBlnSp	Delete specified blanket order line
DeleteCoitemSp	Delete specified customer order line
DeleteCoSp	Delete the customer order from remote (ship) sites
DeleteRemoteNotesSp	Delete notes tied to a record at a remote site
euro_parms_mst_all	Euro parameters - used throughout the system
featqty_mst_all	Feature option adjustment. Used only with the product (features-and-options) configurator.
featrank_mst_all	Feature rank
feature_mst_all	Feature group. Used only with the product (features-and-options) configurator.
inv_hdr_mst_all	Invoice header
inv_item_mst_all	Invoice line item
inv_stax_mst_all	Invoice sales tax
InvAdjCSp	When posting an invoice adjustment, this stored procedure updates the discount and price on the customer order line (potentially cross-site)

Replication category tables

COE object name	Used for
item_glbl	Global Items
item_mst_all	Items - used throughout the system
ItemCreateFromFeatStrSp	Create item from feature string
itemcust_mst_all	Customer/item cross reference
itemcustprice_mst_all	Historical customer item pricing
ItemGlblAddDelSp	Add or delete a global item
itemloc_mst_all	Item stockroom location
ItemlogSp	Create a coitem-log record.
itemprice_mst_all	Item price
itemwhse_mst_all	Item warehouse
job_mst_all	Jobs
LoadReplicatedNotesSp	Take a row out of the NotesContentShadow table and updates the matching system, user, or specific note. If the note does not exist, it is created.
location_mst_all	Location codes
lot_mst_all	Lots - used throughout the system
MakeRemoteObjectNotesSp	Create an ObjectNotes record at the remote site. It assumes the system, user, or specific notes records have already been created.
NotesContentShadow	System, user, or specific note information used to populate the appropriate notes record at the remote site.
parms_mst_all	General parameters - used throughout the system
periods_mst_all	Accounting periods - used in many financial areas
pricecode_mst_all	Price codes
priceformula_mst_all	Price formulas
pricematrix_mst_all	Price matrix
proj_inv_item_mst_all	Project bill of lading line item
RebalCuSp	Rebalance customer balances
RemoteCoHld4Sp	As part of the process to take orders off of credit hold, this stored procedure changes the credit hold information for each customer order in the range and then calls RemoteCoHld5Sp.
RemoteCoHld5Sp	As part of the process to take orders off of credit hold, this stored procedure changes the information in the shipping site.
RemoteOrderCreditHoldSp	Put orders on credit hold in each site listed in the site group.

COE object name	Used for
RemoteSetArtranCorpCustSp	Corporate customers in A/R transactions
RepApsCoitemSp	Called after the planner completes to replicate CO Line projected dates to the originating sites
RepCoBlInSp	Replicate blanket order.
RepCoCreditHoldSp	Replicate credit hold information.
RepCoitemSp	Replicate customer order line (multi-site).
RepCoSp	Replicate customer order (multi-site).
RepCustomerBillToSp	Replicate information for the Bill-To customer (customer sequence = 0). This is called when replicating a customer order to conditionally create the customer record.
RepCustomerShipToSp	Replicate information for the Ship-To customer (customer sequence > 0). This is called when replicating a customer order to conditionally create the customer record.
slsman_mst_all	Salespersons
SumCoSp	Recalculate taxes on a customer order and assign the total price
tax_item_jur_mst_all	Item tax code
tax_jur_mst_all	Tax jurisdiction
transfer_mst_all	Transfer orders
TransferNotesToSiteSp	Allow all the notes for a particular row of a table to be copied to a remote site.
u_m_conv_mst_all	Units of measure
u_m_mst_all	Unit of measure conversions
UpdObalSp	Update customer order balance

Customer Portal category

Customer Portal object name	Used for
item_portal_price_mst_all	Prices on portal items
ItemPortalPriceStatusChangeSp	Status change on portal item prices
PortalAccountCreateOrCopySp	Creating or copying portal user accounts
PortalOrderOnHoldCheckSp	Check if order is on hold

Dimensions category

Dimensions object name	Used for
CLM_DimCatTableSp	Dimensions
CLM_DimensionBindingSp	Dimensions
CLM_DimSubCollectionSp	Dimensions
CLM_DimTable2Sp	Dimensions
dim_attribute	Dimension attributes
dim_base_unit	Dimension base units
dim_function	Dimension functions
dim_object_attribute	Dimension object attributes
dim_object_table_join	Dimension table joins
dim_unit	Dimension units
dim_unit_prefix	Dimension unit prefixes
dimension	Dimensions
dimension_object	Dimension objects
GetPeriod	Accounting period
List_DimCatTableSp	Dimensions
LoadValueResSp	

ESB category

This category contains stored procedure names used to clear the site's ReplQListener BOD definition cache and PARMS cache and to trigger each BOD. The stored procedure names do not map to actual stored procedures and are used purely as a triggering mechanism in the ReplQListener service. For more information about how this works, see the online help topic "Behind the Scenes: How the System Generates a BOD."

For information about the user events that trigger each BOD, see the appropriate integration guide or the **Documentation** tab on the Replication Document Outbound Cross-References form.

EXTFIN category

EXTFIN object name	Used for
ExtFinAnaLedgerPosting	Export data from the CloudSuite Business ana_ledger table.
ExtFinAPVoucherPosting	Export data from the CloudSuite Business export_aptrx and export_aptrxd tables, which are holding tables for data collected from various A/P tables.
ExtFinARInvoicePosting	Export data from the CloudSuite Business export_arinv and export_arinvd tables, which are holding tables for data collected from various A/R tables.
ExtFinLedgerPosting	Export data from the CloudSuite Business ledger table.
ExtFinRequestBankHdr	Export a request to the external financial application for updates to the CloudSuite Business bank_hdr table.
ExtFinRequestChart	Export a request to the external financial application for updates to the CloudSuite Business chart table.
ExtFinRequestCountry	Export a request to the external financial application for updates to the CloudSuite Business country table.
ExtFinRequestCurrate	Export a request to the external financial application for updates to the CloudSuite Business currate table.
ExtFinRequestCurrency	Export a request to the external financial application for updates to the CloudSuite Business currency table.
ExtFinRequestCustomerPostedBalance	Export a request to the external financial application for a customer's posted balance.
ExtFinRequestDept	Export a request to the external financial application for updates to the CloudSuite Business dept table.
ExtFinRequestLanguageIDs	Export a request to the external financial application for updates to the CloudSuite Business LanguageIDs table.
ExtFinRequestPeriods	Export a request to the external financial application for updates to the CloudSuite Business periods table.
ExtFinRequestTaxcode	Export a request to the external financial application for updates to the CloudSuite Business taxcode table.
ExtFinRequestTerms	Export a request to the external financial application for updates to the CloudSuite Business terms table.
ExtFinRequestUnitCd1	Export a request to the external financial application for updates to the CloudSuite Business unitcd1 table.
ExtFinRequestUnitCd2	Export a request to the external financial application for updates to the CloudSuite Business unitcd2 table.

EXTFIN object name	Used for
ExtFinRequestUnitCd3	Export a request to the external financial application for updates to the CloudSuite Business unitcd3 table.
ExtFinRequestUnitCd4	Export a request to the external financial application for updates to the CloudSuite Business unitcd4 table.

EXTFIN Customer category

EXTFIN Customer object name	Used for
custaddr_mst	Export CloudSuite Business custaddr information to an external financial application.
customer_mst	Export CloudSuite Business customer information to an external financial application.

EXTFIN Vendor category

EXTFIN Vendor object name	Used for
vendaddr_mst	Export CloudSuite Business vendaddr information to an external financial application.
vendor_mst	Export CloudSuite Business vendor information to an external financial application.

G/L category

G/L object name	Used for
ana_ledger_mst_all	Analytical ledger transactions
ana_pertot_mst_all	Analytical ledger period total
ChangeReportsToCopyChartSp	Changes for reporting to different entity
ChangeReportsToCopyPeriodSp	Changes for reporting to different entity
ChangeReportsToCSp	Changes for reporting to different entity

G/L object name	Used for
ChangeReportsToDelPeriodsSp	Changes for reporting to different entity
ChangeReportsToPSP	Changes for reporting to different entity
ChangeReportsToSetCurrCodeSp	Changes for reporting to different entity
ChangeReportsToZSP	Changes for reporting to different entity
chart_bp_mst_all	Budget and plans
chart_mst_all	Chart of accounts - used throughout the system
chart_unitcd1_mst_all	Unit code 1 information on chart of accounts
chart_unitcd2_mst_all	Unit code 2 information on chart of accounts
chart_unitcd3_mst_all	Unit code 3 information on chart of accounts
chart_unitcd4_mst_all	Unit code 4 information on chart of accounts
ChartAcctRemoteSp	Replicate changes to chart of accounts to remote sites
curr_uk_mst_all	Customs and excise exchange rates
currate_mst_all	Currency rates - used throughout the system
currency_mst_all	Currency codes (local) - used throughout the system
currparms_mst_all	General currency parameters
DeleteRemoteNotesSp	Delete notes tied to a record at a remote site
euro_parms_mst_all	Euro parameters - used throughout the system
ExecuteSQLSp	
FinRptLinRmtSiteTransSp	Transfer line to remote site
FinRptXMLBufCopySp	Called from Financial Report Line Copy to create the complete Financial Statement in the destination site.
GLBudgetCommitSp	Commits budget by moving tmp_chart_bp_entity to chart_bp; adds unit codes if they don't exist.
GLBudgetConsChartBpUpdateSp	Used in budget consolidation
GIBudgetDelChartbpSp	Delete hierarchy from chart_bp
glrptl_mst_all	G/L report line
journal_mst_all	Only used by the Journal Transaction Report. If you do not need to see Journal records from another site, this is not needed.
ledger_mst_all	Ledger transactions
LedgerConsolCommitSp	Add new transaction records into the entity ledger (for ledger consolidation). Also insert records into unitcd{1-4} tables based upon unit codes within ledger rows that are consolidated.

Replication category tables

G/L object name	Used for
LedgerConsolConsolCtaSp	Update the CTA account (for ledger consolidation)
LedgerConsolCtaAdjSp	Adjust the CTA amount (for ledger consolidation)
LedgerConsolLedgerSp	Intermediate step in ledger consolidation
LoadReplicatedNotesSp	Take a row out of the NotesContentShadow table and updates the matching system, user, or specific note. If the note does not exist, it is created.
MakeRemoteObjectNotesSp	Create an ObjectNotes record at the remote site. It assumes the system, user, or specific notes records have already been created.
NotesContentShadow	System, user, or specific note information used to populate the appropriate notes record at the remote site.
parms_mst_all	General parameters - used throughout the system
per_sort_mst_all	Period total sort method
per_unit_mst_all	Unit code combination
periods_mst_all	Accounting periods - used in many financial areas
PeriodsRemoteDeleteSp	Delete accounting periods for a fiscal year
PeriodsRemoteSaveSp	Add or update accounting periods for a site
pertot_mst_all	Period total
RepChartSp	Multi-site chart copy
site_hierarchy	Site hierarchy
tmp_fin_rpt_hdr_c_xml	Financial report line copy/update
tmp_fin_rpt_hdr_xml	Financial report line copy/update
tmp_fin_rpt_lin_c_xml	Financial report line copy/update
tmp_fin_rpt_lin_s_xml	Financial report line copy/update
tmp_fin_rpt_lin_xml	Financial report line copy/update
TransferNotesToSiteSp	Allow all the notes for a particular row of a table to be copied to a remote site.
unitcd1_mst_all	Unit Code 1
unitcd2_mst_all	Unit Code 2
unitcd3_mst_all	Unit Code 3
unitcd4_mst_all	Unit Code 4

Initialize _All Parameters category

Initialize _All Parameters object name	Used for
apparms_mst_all	Accounts payable parameters
aps_parm_mst_all	APS parameters
arparms_mst_all	Accounts receivable parameters
coparms_mst_all	Customer order parameters
currency_mst_all	Currency parameters
currparms_mst_all	Currency parameters
dcparm_mst_all	Data collection parameters
euro_parms_mst_all	European community parameters
invparms_mst_all	Inventory parameters
mrp_parm_mst_all	MRP parameters
parms_mst_all	General parameters
per_sort_mst_all	Accounting period parameters
poparms_mst_all	Purchasing parameters
tax_system_mst_all	Tax parameters
taxparms_mst_all	Tax parameters

Inventory/Transfers category

Inv/Transfer object name	Used for
chart_mst_all	Chart of accounts - used throughout the system
chart_unitcd1_mst_all	Unit code 1 information on chart of accounts
chart_unitcd2_mst_all	Unit code 2 information on chart of accounts
chart_unitcd3_mst_all	Unit code 3 information on chart of accounts
chart_unitcd4_mst_all	Unit code 4 information on chart of accounts
ChkSnSp	Validate serial numbers (matching item/has an available status)
CLM_TransferOrderShpRcvSp	Transfer order ship/receive
country_mst_all	Countries

Replication category tables

Inv/Transfer object name	Used for
CpTSp	Copy transfer orders and lines
curr_uk_mst_all	Customs and excise exchange rates
currate_mst_all	Currency rates - used throughout the system
currency_mst_all	Currency codes (local) - used throughout the system
currparms_mst_all	General currency parameters
dcparm_mst_all	Data Collection parameters
del_term_mst_all	Delivery Terms
DeleteRemoteNotesSp	Delete notes tied to a record at a remote site
euro_parms_mst_all	Euro parameters - used throughout the system
featqty_mst_all	Feature option adjustment. Used only with the product (features-and-options) configurator.
feature_mst_all	Feature group. Used only with the product (features-and-options) configurator.
GetTransferToSiteRecordDateSp	Record date for transfer to site
laPostSp	Issues material and adjusts quantity-on-hand at a warehouse, location, and lot.
InsertOverrideForItemLotAttrSp	Item lot attributes
InsertOverrideForItemPiecesSp	Item pieces
intranet	Intranets
invparms_mst_all	Inventory parameters
item_glbl	Global Items
item_manufacturer_item_mst_all	Cross-reference of CloudSuite Business item to manufacturer item
item_mst_all	Items - used throughout the system
ItemGlblAddDelSp	Add or delete a global item
itemloc_mst_all	Item stockroom location
ItemLocAddRemoteSp	Performs either a local or a remote call for the ItemLocAddSp routine (which creates itemloc records)
itemprice_mst_all	Item price
itemwhse_mst_all	Item warehouse
jobmatl_mst_all	Used only with the product (features-and-options) configurator.
jobroute_mst_all	Used only with the product (features-and-options) configurator.
LcrcptSp	Create a Landed Cost receipt record.

Inv/Transfer object name	Used for
LoadReplicatedNotesSp	Replicated notes
location_mst_all	Location codes
lot_loc_mst_all	Item Lot Location - used throughout the system
lot_mst_all	Lots - used throughout the system
LotAddRemoteSp	Called at a remote site from the local site's LotAddSp routine when the lot being added goes to a remote site.
MakeRemoteObjectNotesSp	Object notes
manufacturer_item_mst_all	Manufacturer items
manufacturer_mst_all	Manufacturers of items
matltrack_mst_all	Lot and serial number tracking
mcal_mst_all	Manufacturing days
MsmptSp	Process transfer orders in multi-site move posting
NotesContentShadow	Notes
parms_mst_all	General parameters - used throughout the system
periods_mst_all	Accounting periods - used in many financial areas
pricecode_mst_all	Price codes
priceformula_mst_all	Price formulas
pricematrix_mst_all	Price matrix
prodcode_mst_all	Product codes
qualify_mst_all	Feature qualifying string
RemoteLoadTmpSerSp	Copy the tmp_ser serial number information to a remote site.
RepAPSTrnItemSp	Replicate APS item
rsvd_inv_mst_all	Reservation - used in many areas of the system
serial_mst_all	Serial numbers - used in many areas of the system
shipcode_mst_all	Ship codes
site	Sites/entities - used throughout the system
system_type	System types
trans_nature_2_mst_all	Nature of transaction codes
trans_nature_mst_all	Secondary nature of transaction codes
TransCpSp	Copy Transfer Order record changes to a remote site. If the sites have different base currencies, the freight, duty, insurance,

Replication category tables

Inv/Transfer object name	Used for
	local freight and brokerage amounts are converted to the other site's currency during the copy process.
TransDeleteSp	Delete a transfer order.
transfer_mst_all	Transfer orders
TransferNotesToSiteSp	Include transfer order notes
TransferOrderShipSp	Transfer order ship
TritemDeleteSp	Delete a transfer order line item.
TritmCpSp	Copy Transfer Order item record changes to a remote site. If the sites have different base currencies, the costs and price are converted to the "other" site's currency during the copy process.
TrnSsdSp	Copy Transfer Order SSD information to a remote site.
Trpurge1Sp	Delete Transfer Orders and related records from remote sites
u_m_conv_mst_all	Unit of measure conversion
u_m_mst_all	Unit of measure codes (all sites)
unitcd1_mst_all	Unit Code 1
unitcd2_mst_all	Unit Code 2
unitcd3_mst_all	Unit Code 3
unitcd4_mst_all	Unit Code 4
UpdateOverrideForItemPiecesSp	Item pieces
UpdateTransferExchRateSp	Update transfer order exchange rate
UpdWhseSp	Update warehouse information - used in Combine Transfer Order Ship/Receive
whse_mst_all	Warehouses

Invoice Builder category

Invoice Builder object name	Used for
arinv_mst_all	Invoices
artran_mst_all	A/R transactions
AU_InvPostingSp	Automotive Industry Pack posting
BGTaskSubmitSp	Submit background task

Invoice Builder object name	Used for
coparms_mst_all	Customer order parameters (includes invoice length, used in many A/R functions)
currparms_mst_all	General currency parameters
custaddr_mst	Customer address
customer_mst_all	Customers information
ExtFinAddBatchToBGQueueSp	External financials
inv_hdr_mst_all	Invoice header
inv_item_mst_all	Invoice line item
inv_stax_mst_all	Invoice sales tax
InvoiceBuilderCopySp	Copy invoice
InvoiceBuilderReprintSp	Reprint invoice
InvoicingBGSp	Invoicing background task
InvPostingArinvdSnapShotSp	Invoice posting - invoice/voucher distribution
InvPostingAutoDistSp	Invoice posting - auto distribution
InvPostingCreateTTSp	Invoice posting - create temp table
InvPostingLockJournSp	Lock journal during invoice posting
InvPostingSp	Invoice posting
InvPostingVerifyPrintSp	Invoice posting
item_mst_all	Items - used throughout the system
parms_mst_all	General parameters - used throughout the system
Rpt_InvoiceTransactionSp	

Journal Builder category

Journal Builder object name	Used for
chart_mst_all	Chart of accounts - used throughout the system
chart_unitcd1_mst_all	Unit code 1 information on chart of accounts
chart_unitcd2_mst_all	Unit code 2 information on chart of accounts
chart_unitcd3_mst_all	Unit code 3 information on chart of accounts
chart_unitcd4_mst_all	Unit code 4 information on chart of accounts

Replication category tables

Journal Builder object name	Used for
currparms_mst_all	General currency parameters
JournalBuilderProcessSp	Validation and processing of transactions listed in Journal Builder
parms_mst_all	General parameters - used throughout the system
unitcd1_mst_all	Display unit code description
unitcd2_mst_all	Display unit code description
unitcd3_mst_all	Display unit code description
unitcd4_mst_all	Display unit code description

Ledger Consolidation category

Ledger Console object name	Used for
ChangeReportsToCopyChartSp	Changes for reporting to different entity
ChangeReportsToCopyPeriodSp	Changes for reporting to different entity
ChangeReportsToCSp	Changes for reporting to different entity
ChangeReportsToDelPeriodsSp	Changes for reporting to different entity
ChangeReportsToPSP	Changes for reporting to different entity
ChangeReportsToSetCurrCodeSp	Changes for reporting to different entity
ChangeReportsToZSp	Changes for reporting to different entity
chart_mst_all	Chart of accounts (replicates only to child sites) - used throughout the system
ChartAcctRemoteSp	Replicate changes to chart of accounts to remote sites
curr_uk_mst_all	Customs and excise exchange rates
currate_mst_all	Currency rates - used throughout the system
currency_mst_all	Currency codes (local) - used throughout the system
currparms_mst_all	General currency parameters
DeleteRemoteNotesSp	Delete remote notes
euro_parms_mst_all	Euro parameters - used throughout the system
GLBudgetCommitSp	Commits budget by moving tmp_chart_bp_entity to chart_bp; adds unit codes if they don't exist.
GLBudgetConsChartBpUpdateSp	Used in budget consolidation

Ledger Console object name	Used for
GIBudgetDelChartbpSp	Delete hierarchy from chart_bp
LedgerConsolCommitSp	Add new transaction records into the entity ledger (for ledger consolidation). Also insert records into unitcd{1-4} tables based upon unit codes within ledger rows that are consolidated.
LedgerConsolConsolCtaSp	Update the CTA account (for ledger consolidation)
LedgerConsolCtaAdjSp	Adjust the CTA amount (for ledger consolidation)
LedgerConsolLedgerSp	Intermediate step in ledger consolidation
LoadReplicatedNotesSp	Take a row out of the NotesContentShadow table and updates the matching system, user, or specific note. If the note does not exist, it is created.
MakeRemoteObjectNotesSp	Create an ObjectNotes record at the remote site. It assumes the system, user, or specific notes records have already been created.
NotesContentShadow	System, user, or specific note information used to populate the appropriate notes record at the remote site.
parms_mst_all	General parameters - used throughout the system
periods_mst_all	Accounting periods - used in many financial areas
PeriodsRemoteDeleteSp	Delete accounting periods for a fiscal year
PeriodsRemoteSaveSp	Add or update accounting periods for a site
RepChartSp	Multi-site chart copy
TransferNotesToSiteSp	Transfer notes to a remote site

Ledger Detail category

Ledger Detail object name	Used for
chart_mst_all	Chart of accounts - used throughout the system
matltran_amt_mst_all	Material transactions
matltran_mst_all	Material transaction amounts
vch_pr_mst_all	Voucher pre-register
vch_pr_stax_mst_all	Voucher pre-register sales tax

Manufacturer Item category

Manufacturer Item object name	Used for
item_manufacturer_item_mst_all	Cross-reference of CloudSuite Business item to manufacturer item
manufacturer_item_mst_all	Items manufactured by other companies
manufacturer_mst_all	Manufacturers of items

Multi-Site Home form categories

These categories allow you to view related information from other sites in the appropriate Home form:

- Multi-Site Buyer
- Multi-Site Controller
- Multi-Site CRM (Salesperson Home)
- Multi-Site Controller
- Multi-Site Customer Service
- Multi-Site Inventory Control
- Multi-Site Production Planner
- Multi-Site Project Manager

Multi-Site BOM Builder category

Multi-Site BOM Builder object name	Used for
CreateCurrentMaterialReferenceSp	Current material references
CreateCurrentMaterialSp	Current materials
CreateCurrentOperationResourceGroupSp	Resource groups
CreateCurrentOperationSp	Current routing and scheduling
CreateItemFeatureRankSp	Item feature ranking
CreateRemoteNoteSp	BOM notes
MultiSiteBOMCopySp	Overall copy of BOM

Multi-Site Customers category

Multi-Site Customers object name	Used for
bank_hdr_mst_all	Bank information
country_mst	Countries - used throughout the system
currency_mst	Currency codes - used throughout the system
currparms_mst_all	Currency parameters
customer_mst	Customers
CustomerInsUpdSp	Insert/update customers
CustShipToInsUpdSp	Insert/update customer ship-tos
del_term_mst_all	Delivery terms
endtype_mst_all	End user type (sales accounts)
inv_category_mst_all	Invoice categories
pricecode_mst_all	Price codes
reason_mst_all	Reason codes
sales_team_mst_all	Sales teams
shipcode_mst_all	Ship codes
terms_mst_all	Billing terms
territory_mst_all	Sales territories
trans_nature_2_mst_all	Secondary NOTC codes
trans_nature_mst_all	NOTC codes

Multi-Site Items category

Multi-Site Items object name	Used for
aps_parm_mst_all	APS parameters
attribute_group_mst_all	Item attribute groups
attribute_value_mst_all	Item attribute values
commodity_mst_all	Commodity codes
country_mst_all	Countries
currparms_mst_all	General currency parameters

Replication category tables

Multi-Site Items object name	Used for
distacct_mst_all	Distribution accounts
exc_mesg_mst_all	
famcode_mst_all	Family codes
Home_MRPSupDemSp	
invparms_mst_all	Inventory parameters
item_mst_all	Item information - used throughout the system
ItemInsUpdSp	Insert/update items
itemloc_mst_all	Lot/locations
itempiece_mst_all	Item pieces
itemwhse_mst_all	Item/warehouses
job_mst_all	Job information - used throughout the system
jobmatl_mst_all	Job materials
jobroute_mst_all	Job routings
location_mst_all	Item locations
poparms_mst_all	Purchase order parameters
prod_mix_mst_all	Co-product mixes
prodcodes_mst_all	Product codes
reason_mst_all	Reason codes
setupgroup_mst_all	Setup groups
tax_free_import_item_mst_all	Tax free import items
u_m_mst_all	Unit of measures
whse_mst_all	Warehouses

Planning category

Planning object name	Used for
RepApsTplnBulkDelSp	Bulk deletion of planned transfer demand records
RepApsTplnDelSp	Delete planned transfer demand records
RepApsTplnSp	Create the planned transfer demand at the supplying site

PO - CO - Across Sites category

PO-CO object name	Used for
cfg_main_mst_all	Configuration details
co_bln_mst_all	Customer orders
co_mst_all	Blanket orders
coitem_mst_all	Customer order lines
country_mst_all	Countries
currency_mst_all	General currency parameters
cust_lcr_mst_all	Customer letters of credit
custaddr_mst	Customer addresses
customer_mst_all	Customers
del_term_mst_all	Delivery terms
DemandingPoCoUnlinkSp	Unlink the Source Site to remove the PO-CO relationship.
DemandingPoSourceCoSyncSp	From the Demanding Site to the Source Site, generate and sync the Source Site CO based on changes to the Demanding Site's PO.
itemwhse_mst_all	Item warehouse
MakeRemoteObjectNotesCrossTableSp	Transfer demand PO line notes to source site customer order line
matltran_mst_all	Material transactions
parms_mst_all	General parameters
po_bln_mst_all	Purchase orders
po_mst_all	Blanket purchase orders
poitem_mst_all	Purchase order lines
preassigned_lot_mst_all	Preassigned lots
serial_mst_all	Serial numbers
slsman_mst_all	Salespersons
SyncCoFromPoSp	Synchronize customer order from purchase order
UpdateCoNumonDemandingPoSp	On shipping of the CO, update the PO based on flag settings
vendor_mst_all	Vendors

Purchase Order Builder category

PO Builder object name	Used for
apparms_mst_all	Accounts payable parameters - used in A/P payment distribution and generation
bank_hdr_bank_file_fmt_mst_all	Bank header bank file format information
BuilderPOUpdateSp	In print site, update temp table with PO data from remote sites, to create Builder PO Report
chart_mst_all	Chart of accounts (replicates only to child sites) - used throughout the system
chart_unitcd1_mst_all	Unit code 1 information on chart of accounts
chart_unitcd2_mst_all	Unit code 2 information on chart of accounts
chart_unitcd3_mst_all	Unit code 3 information on chart of accounts
chart_unitcd4_mst_all	Unit code 4 information on chart of accounts
currency_mst_all	Currency codes (local) - used throughout the system
currparms_mst_all	General currency parameters
ExecuteSQLSp	Loads PLN data from other site
item_mst_all	Items - used throughout the system
parms_mst_all	General parameters - used throughout the system
po_bln_mst_all	Purchase orders
po_mst_all	Blanket purchase orders
POBuilderCopySp	Copy temp table data from Builder PO site to target sites
POBuilderCreateSp	Create PO in target site
poitem_mst_all	Purchase order lines
shipcode_mst_all	Shipping codes
shipto_mst_all	Ship To information
u_m_conv_mst_all	Unit of measure codes (all sites)
u_m_mst_all	Unit of measure conversion
unitcd1_mst_all	Unit code description
unitcd2_mst_all	Unit code description
unitcd3_mst_all	Unit code description
unitcd4_mst_all	Unit code description
vendcat_mst_all	Vendor categories

PO Builder object name	Used for
vendor_mst_all	Vendor information - used throughout the system
whse_mst_all	Warehouses

Service - Global Incidents category

Service- Global Incidents object name	Used for
DeleteRemoteNotesSp	Delete remote notes
fs_consumer_mst	Consumers
fs_event_code_mst	Service event code
fs_event_mst	Service event
fs_event_mst_all	Service event - remote sites
fs_inc_reason_mst	Incident reason
fs_inc_stat_mst	Incident status
fs_incident_mst	Incidents
fs_incident_mst_all	Incidents - remote sites
fs_partner_mst_all	Partners
fs_prior_code_mst	Priority codes
fs_reas_gen_mst	General reasons
fs_reas_spec_mst	Specific reasons
fs_res_gen_mst	
fs_res_spec_mst	
fs_sro_line_mst_all	Service order lines
fs_sro_mst_all	Service orders
fs_sro_oper_mst_all	Service order operations
fs_stat_code_mst	Status codes
SSSFSSROCopyCreateSroSp	Create or copy service orders
SSSFSSROCopyLinesSp	Copy lines
TransferNotesToSiteSp	Copy lines to remote sites

Service - Global Scheduling Shared Partners category

Service- Global Scheduling Shared Partner object name	Used for
certification_mst	Certification
fs_appt_stat_mst	Appointment status
fs_appt_type_mst	Appointment type
fs_incident_mst_all	Incidents
fs_partner_area_mst	Partner area
fs_partner_cert_mst	Partner certification
fs_partner_loc_mst	Partner location
fs_partner_mst	Partners
fs_partner_skill_mst	Partner skills
fs_partner_team_mst	Partner teams
fs_region_mst	Regions
fs_schedule	Schedules
fs_sro_line_mst_all	Service order lines
fs_sro_mst_all	Service orders
fs_sro_oper_mst_all	Service order operations
skill_mst	Skills

Service - Global Service History category

Service- Global Service History object name	Used for
fs_consumer_mst	Consumers
fs_cont_line_mst_all	Contract lines
fs_contract_mst_all	Contracts
fs_customer_mst_all	Customers
fs_event_mst_all	Service events
fs_incident_mst_all	Incidents
fs_partner_mst_all	Partners

Service- Global Service History object name	Used for
fs_sro_line_mst_all	Service order lines
fs_sro_mst_all	Service orders
fs_sro_oper_mst_all	Service order operations
fs_unit_cons_mst_all	Unit configurations
fs_unit_meter_mst_all	Unit metering
fs_unit_mst_all	Units
fs_unit_stat_mst_all	Unit status

Service - Global Units category

Service - Global Units object name	Used for
fs_config_mst	Configurations
fs_consumer_mst	Consumers
fs_partner_mst_all	Partners
fs_unit_cons_mst	Unit configurations
fs_unit_mst	Units
fs_unit_stat_code_mst	Unit status codes
fs_unit_stat_mst	Unit status
fs_unit_warr_mst	Unit warrantys
fs_warr_code_mst	Unit warranty codes
reason_mst	Reasons
whse_mst_all	Service warehouses

Service - Multi-Site SRO Copy category

Service - Multi-Site SRO Copy object name	Used for
SSSFSMultiSiteSroCopySp	Copy service order to remote site

Replication category tables

Service - Multi-Site SRO Copy object name	Used for
SSSFSMultiSiteSroSubCopySp	Copy service order to remote site

Shared Currency category

Shared Curr object name	Used for
country_mst	Country codes - used throughout the system
curr_uk_mst	Customs and excise exchange rates
CurrAcctSp	Create a curracct row in the remote site for the currency row just added in the local site. (The record is created but account information is not replicated.)
currate_mst	Currency rates - used throughout the system
currency_mst	Currency rates - used throughout the system

Site Admin category

Site Admin object name	Used for
chart_mst_all	Chart of accounts - used throughout the system
DefineVariableSp	Define variables for translation strings
EmailType	Email type from Users
intranet	Intranets
IntranetSharedTable	Intranet shared tables
PasswordParameters	Password verification
RemoteDataPullSp	Bulk copy of data between connected databases
site	Sites/entities - used throughout the system
site_group	Site groups - used throughout the system
site_hierarchy	Site hierarchy (Reports To entity)
site_link_info	Linked sites
sitenet_mst	Inter-site parameters

Site Admin object name	Used for
system_type	System types
UpdateAllTablesSp	Update _All tables
UserNamesRemoteUpdateSp	User password, e-mail address, and workstation login

Vendor Portal category

Vendor Portal object name	Used for
PortalAccountCreateOrCopySp	Create or copy portal user account

Voucher Builder category

Voucher Builder object name	Used for
aptrx_mst_all	A/P transactions
aptrxp_mst_all	A/P posted transactions - used in many A/P areas
currparms_mst_all	General currency parameters
item_mst_all	Items - used throughout the system
lc_rcpt_mst_all	Landed cost receipts
ManualVoucherBuilderProcessSp	Manual voucher builder
parms_mst_all	General parameters - used throughout the system
po_mst_all	Purchase orders
po_rcpt_mst_all	Purchase order receipts
po_vch_mst_all	Purchase order voucher log
poitem_mst_all	Purchase order lines
poparms_mst_all	Purchase order parameters
tax_system_mst_all	Tax systems - used in A/P payment generation and A/P check/draft/wire/EFT printing/posting
trans_nature_2_mst_all	Nature of transaction codes
trans_nature_mst_all	Secondary nature of transaction codes
u_m_conv_mst_all	Unit of measure codes (all sites)

Replication category tables

Voucher Builder object name	Used for
u_m_mst_all	Unit of measure conversion
vch_hdr_mst_all	Voucher register
vendaddr_mst	Vendor addresses
vendor_mst_all	Vendor information - used throughout the system
VoucherBuilderCopySp	Copy selected tmp_voucher_builder rows from Builder Voucher originating site to target site
VoucherBuilderCreateVoucherSp	Runs in the site where voucher or an adjustment needs to be created. Performs validations based on target site's data, calls procedures to calculate taxes based on target site's tax codes, and calls procedures to create one un-posted voucher, voucher distributions including tax distributions, and voucher register rows.

Glossary

A/P

Accounts payable

A/R

Accounts receivable

APS

Advanced Planning System, which generates real-time projections of when you can complete orders by comparing all demands (such as customer orders) against a long-term plan. The system views the current status of inventory levels, forecasts, job schedules, PO due dates, customer orders, etc. and creates planned orders accordingly to satisfy the demands. You then "firm" the planned orders into purchase orders, purchase requisitions, job orders, production schedules, or transfer orders.

Asynchronous replication

Another term sometimes used for non-transactional replication.

ATP

Available to Promise function of APS.

BOD

Business Object Document, an XML document standard defined by Open Applications Group Integration Specifications (OAGIS). This type of document is used when interfacing with many other Infor applications.

BOM

Bill of Material, which is a listing of all the subassemblies, intermediates, parts, and raw materials that go into a parent assembly showing the quantity of each required to make an assembly.

CO

Customer order

CPM

Infor performance management solution providing a closed loop between strategy, planning, budgeting, financial reporting and analysis. CPM interfaces with CloudSuite Business and also with Infor financial management solutions.

CPQ

Product configuration application that interfaces with CloudSuite Business. Formerly known as BuyDesign or PCM.

CTP

Capable to Promise function of APS

Data collection

Collection of data through handheld devices or barcode readers.

EAM

Infor enterprise asset management application that interfaces with CloudSuite Business.

EDI

Electronic Data Interchange, which allows companies to exchange transaction data through data files in an ANSI standard format. CloudSuite Business is integrated with an EDI translator. CloudSuite Business imports inbound transactions from the translator and exports outbound transactions to the translator.

Entity

A level of business operation with a complete set of financial statements, its own defined currency code and rates, and its own chart of accounts and accounting periods. An entity does not allow for business activity aside from period, chart, and currency maintenance and the reporting of its consolidated ledger and budgets. See "Entities" on page 35.

FOB

Free On Board. The site designated as the FOB point controls much of the CloudSuite Business costing functionality. In the Transfer Order system, you can identify the FOB point as either the Ship Site or the Receive Site. You must specify the FOB point for all inter-company movements.

Form

In the CloudSuite Business user interface, the equivalent of a screen or a window. See .

G/L

General ledger

Intranet

In CloudSuite Business, represents a logical grouping of sites in your enterprise. An intranet may represent a grouping of CloudSuite Business sites that exist together on a high-speed network, and for which you want common administration. (Common administration can include replication, or creation of master sites.) An intranet may also represent an external non-CloudSuite Business system, allowing you to set up replication rules between CloudSuite Business sites and external systems.

Landed cost

Includes freight, duty, brokerage, insurance, and local freight on purchase orders, transfer orders, or goods receiving notes.

License module

Gives users access to certain specified functionality within CloudSuite Business. You purchase specific license modules based on your company's needs.

For example, if your company is planning to use APS, you would purchase the AdvancePlanningScheduling license module.

Lot-tracked item

Item that is marked as being in a specific lot, which is a quantity produced together and sharing the same production costs and resulting specifications.

Master site

CloudSuite Business site that controls some data for all other sites on an intranet. For example, master sites are used with the Multi-Site Shared Tables feature.

MRP

Material Requirements Planning, which plans requirements in order by the lowest level in which the item appears in a bill of material. That is, it plans all end items first, then all items at the next level, and so on, backward planning each requirement from the requirement's needed date to the item's lead time, batching together requirements needed at the same period of time.

Multi-site table

A database table that includes a site_ref column. Records for various sites are stored in the table, and the value of the site_ref column determines which site the record belongs in.

Non-transactional replication

Uses inbound/outbound queues and XML documents to replicate content (data) or to pass application calls (RPCs). Non-transactional replication can occur at any of these intervals: Immediate (which means updates go directly into the replication queue), or at a set number of minutes, hours, or days. Once the data is in the queue, it will be processed by the Replication service when the specified time interval has elapsed.

PLM

Infor product lifecycle management application that interfaces with CloudSuite Business

PO

Purchase order

PortalSiteGroup data source

The multiplex data source that includes all CloudSuite Business sites that are included in the portal group of sites.

PrimarySite data source

For Customer Portal and Vendor Portal, the data source that points to a site in the portal site group. This site is the default data source, where all items and item categories, and certain other data, are maintained.

Pro forma invoice

A document that verifies the value of goods, when the goods cross borders. The value of goods is in the from-warehouse's or the from-site's domestic currency. Although pro forma invoices are typically used for international shipping transactions, you can also use them for domestic shipping transactions if desired.

Pull transaction

Transaction that moves or transfers material from Site B to Site A.

For example, Site A moves material from Site B. Site A is considered the To Site and Site B is considered the From Site. The quantity will be moved from Site B to Site A. The quantity comes from Site B to Site A. The transaction uses the cost/price of Site B.

Push transaction

Transaction that moves or transfers material from Site A to Site B.

For example, Site A moves material to Site B. Site A is considered the From Site and Site B is considered the To Site. The quantity will be moved from Site A to Site B. The quantity comes from the From Site. The transaction uses the cost/price of Site A.

Replication

The copying of data between CloudSuite Business sites

Site

Logically, any place where work is done. Thus, a site can correspond to company headquarters, a manufacturing plant, a distribution center, or a legal company that requires financial reporting. Even if all of these facilities share a single physical building, each can be considered a logical site.

Stored procedure

A group of SQL statements compiled into a single execution plan. Stored procedures are stored in the SQL database and executed upon request - through database triggers or calls from an application.

Synchronous replication

Another term sometimes used for transactional replication

Token

Allows one user login for a specified license module. Named user and concurrent user licenses are available, and their use of tokens is different. See the *Infor Cloud Suite Business Licensing Administration Guide* for more information.

Transactional replication

A live constant connection from one site to another. Cloud Suite Business replicates the transaction to the remote site as soon as the user at one site saves changes. It assumes that both the source and target sites are always connected through SQL Server and have the same schema.

Trigger

A special class of stored procedure defined to execute automatically when an UPDATE, INSERT, or DELETE statement is issued against a database table or view. Sites use triggers to enforce business rules automatically when data is modified.

View

A mechanism for gathering elements from SQL tables and assembling them into a virtual table. Generated views simplify database queries by eliminating the need to understand the underlying structure of a database. In Cloud Suite Business, views can be used with master sites, allowing other sites in the intranet to maintain data at the master site.

Also refers to multiple "views" (different data sets) available on CloudSuite Business forms such as Customer Inquiry and Vendor Inquiry.

WIP

Work in process for a product or products in various stages of completion throughout the plant, including all material from raw material that has been released for initial processing up to completely processed material awaiting final inspection and acceptance as finished product. Many accounting systems also include the value of partially finished stock and components in this category.

